

Scalable. Flexible.  
Easy-to-Deploy Video Walls.



# Matrox<sup>®</sup> QuadHead2Go<sup>™</sup> Series

QuadHead2Go Q185 • QuadHead2Go Q155

## User Guide

20278-301-0110  
February 27, 2020

---

# Contents

<b>Matrox safety information</b> .....	<b>5</b>
Installation and operation .....	5
If a power supply (internal or external) was included with your product .....	5
If your product includes laser-based technology .....	6
If your product includes a battery .....	6
Repair .....	6
<b>Overview</b> .....	<b>7</b>
Hardware supplied .....	7
Software available .....	7
Hardware required (sold separately) .....	7
Optional hardware (sold separately) .....	7
Installation overview .....	8
More information .....	8
<b>Getting started</b> .....	<b>9</b>
Configuration guide .....	9
Before you begin .....	9
<b>Installing your QuadHead2Go card</b> .....	<b>10</b>
Before you begin .....	10
Preventing damage to your hardware .....	10
Step-by-step installation .....	10
Installing multiple cards .....	11
<b>Connecting your QuadHead2Go Q185 card</b> .....	<b>12</b>
Before you begin .....	12
Connection overview .....	12
Description of supported connectors .....	13
Step-by-step connection setup .....	13
<b>Connecting your QuadHead2Go Q155 card</b> .....	<b>15</b>
Before you begin .....	15
Connection overview .....	15
Description of supported connectors .....	16
Step-by-step connection setup .....	16

<b>Connecting your QuadHead2Go Q185 unit .....</b>	<b>18</b>
Before you begin .....	18
Connection overview .....	18
QuadHead2Go Q185 – Back .....	18
Description of connectors .....	19
Step-by-step connection setup .....	19
<b>Connecting your QuadHead2Go Q155 unit .....</b>	<b>22</b>
Before you begin .....	22
Connection overview .....	22
QuadHead2Go Q155 – Back .....	22
Description of connectors .....	23
Step-by-step connection setup .....	23
<b>Validating your QuadHead2Go setup .....</b>	<b>25</b>
Connection checklist .....	25
Description of status LEDs .....	25
QuadHead2Go unit .....	25
Network connector .....	26
Validating network discovery .....	26
Multiple subnet support .....	26
<b>Updating your Matrox QuadHead2Go firmware .....</b>	<b>27</b>
Supported operating systems .....	27
Obtaining the Matrox QuadHead2Go firmware updater package .....	27
Before you update your firmware .....	27
Step-by-step instructions .....	28
<b>Matrox PowerWall software .....</b>	<b>30</b>
Before you begin .....	30
Obtaining Matrox PowerWall software .....	30
Installing your software .....	30
Accessing Matrox PowerWall software .....	30
Running Matrox PowerWall .....	31
More information .....	31
<b>Using control buttons on your QuadHead2Go device .....</b>	<b>32</b>
<b>Product information .....</b>	<b>34</b>
Specifications .....	34
QuadHead2Go Q185 card .....	34

QuadHead2Go Q155 card .....	35
QuadHead2Go Q185 unit .....	36
QuadHead2Go Q155 unit .....	37
External power supply .....	38
Environmental .....	38
<b>Appendix A – Matrox secure cable solution .....</b>	<b>39</b>
QuadHead2Go card .....	39
Mini DisplayPort™ .....	39
Mini HDMI® .....	40
QuadHead2Go unit .....	41
<b>Appendix B – Mounting your Matrox unit .....</b>	<b>43</b>
Mounting guidelines .....	43
Mounting your QuadHead2Go unit .....	44
Mounting your units horizontally .....	44
Mounting your units vertically .....	44
Using your angled bracket kit .....	45
Mounting to a 75 or 100 mm mounting space .....	45
Mounting to a 200 mm mounting space .....	45
<b>Customer support .....</b>	<b>46</b>
Matrox web .....	46
Technical support .....	46
Information we need .....	46
Program specific problems .....	47
Software package download .....	47
View your warranty information .....	47
View the third party software notices .....	47
Register your Matrox product .....	47

---

# Matrox safety information



To ensure safe and reliable operation of your Matrox product, to avoid personal injury, and to prevent damage to your computer or Matrox hardware, read the following guidelines.

---

## Installation and operation

- Read and retain all instructions. Only use your Matrox product according to the instructions, operating ranges, and guidelines provided in the Matrox user guide and other related Matrox documentation. Failure to follow these instructions could result in damage to your product or injury to the user or installer.
- Don't expose your Matrox product to rain, water, condensation, or moisture.
- Your Matrox product (card or unit) can become hot while operating. Always turn off your computer, unplug it, then wait for it to cool before touching any of the internal parts of your computer or installing your Matrox card. Allow hot surfaces to cool before touching your Matrox unit. 
- Static electricity can severely damage electronic parts. Before touching any electronic parts, drain static electricity from your body (for example, by touching the metal frame of your computer).
- When handling a card, carefully hold it by its edges and avoid touching its circuitry.
- Don't stack devices or place devices so close together that they're subject to recirculated or preheated air.
- Don't operate your system or Matrox product near a heat source or restrict airflow to your system, and make sure the ambient temperature doesn't exceed the maximum recommended temperatures. Don't block ventilation holes on your unit or system.

---

## If a power supply (internal or external) was included with your product

- Don't place the external power supply directly on top of the device.
- Only use power supplies originally supplied with the product or use a replacement that's approved by Matrox. Don't use the power supply if it appears to be defective or has a damaged chassis.

- Don't defeat the safety purpose of the polarized or grounding-type plug. A polarized plug has two blades with one wider than the other. A grounding-type plug has two blades and a third grounding prong. The wide blade or the third prong are provided for your safety. If the provided plug doesn't fit into your outlet, consult an electrician to replace the obsolete outlet.
- Make sure that nothing rests on the power cables and that the cables aren't located where they can be stepped on, pinched, or tripped over.
- Don't use damaged power cables.
- Unplug your system or device during lightning storms or if unused for long periods of time.

---

## If your product includes laser-based technology

- The device contains a Class 1 laser product for use only under the recommended operating conditions and guidelines. For more information, see your Matrox user guide.
- Invisible laser radiation may be emitted from disconnected fibers or connectors. Don't stare into beams or view directly with optical instruments.
- Only use optical transceivers originally supplied with the product or use a replacement that's approved by Matrox.
- For more information on laser support and compliance, see your Matrox user guide.

---

## If your product includes a battery

- The battery is non replaceable.
- To dispose of your product, see [www.matrox.com/environment/weee](http://www.matrox.com/environment/weee).



---

## Repair

- Don't attempt to open or repair a power supply unit (if one was supplied).
- Don't attempt to open or repair your Matrox product.
- If there's a fault with your Matrox product, review your Matrox warranty for more information.

---

# Overview

Thank you for purchasing a Matrox QuadHead2Go Series product. Matrox QuadHead2Go products are multi-monitor controllers capable of driving a single video source on up to four displays. These controllers available as standalone appliances and PCI Express® cards provide complete video wall scalability and flexibility to power video walls of any type and size.

---

## Hardware supplied\*

Depending on your QuadHead2Go Series product, the following hardware is supplied:

- QuadHead2Go Q185 card – PCIe® card.
- QuadHead2Go Q155 card – PCIe® card.
- QuadHead2Go Q185 unit – Device, 1 power supply.
- QuadHead2Go Q155 unit – Device, 1 power supply.

---

## Software available

- Matrox QuadHead2Go Firmware Updater
- Matrox PowerWall
- Matrox QuadHead2Go REST API

---

## Hardware required (sold separately)

- DisplayPort cable or active adapter (for your monitor type)†
- Network cable (CAT 5, 5e, 6, or 7)
- Certified HDMI® cables‡

---

## Optional hardware (sold separately)

- Matrox secure cable solutions
- Matrox rack mount kit

---

\* The hardware supplied with your Matrox product may vary depending on the SKU or part number of your product. For more information, contact your Matrox representative.

† Only active adapters (sold separately) are supported. Passive adapters aren't supported.

‡ Make sure your HDMI cables and adapters can support your maximum resolution.

- Matrox angled brackets

To purchase optional hardware, contact your Matrox representative.

---

## Installation overview

To install your Matrox product:

- 1 Install your QuadHead2Go card – see “Installing your QuadHead2Go card”, page 10.
- 2 Connect your product –
  - See “Connecting your QuadHead2Go Q185 card” on page 12.
  - See “Connecting your QuadHead2Go Q155 card” on page 15.
  - See “Connecting your QuadHead2Go Q185 unit” on page 18.
  - See “Connecting your QuadHead2Go Q155 unit” on page 22.
- 3 Validate your setup – see “Validating your QuadHead2Go setup”, page 25.
- 4 Install the software – see “Matrox PowerWall software”, page 30. For more information on PowerWall software, see the help file included with your PowerWall software.

---

## More information

Your Matrox user guide provides information on installing and connecting your Matrox hardware. For information on other Matrox software features and options, see the documentation for that software.

For information on how to use and configure Matrox PowerWall software, see the PowerWall help file.

Be sure to check for any last-minute release notes included with your product. Also, check the Matrox web site ([www.matrox.com/graphics](http://www.matrox.com/graphics)) for the latest Matrox software, technical support, and product information.



---

# Getting started

Your QuadHead2Go product has one (1) input connector (DisplayPort, Mini DisplayPort, HDMI, or Mini HDMI) and four (4) HDMI or Mini HDMI output connectors to allow you to receive a signal of up to 8K by 8K and output on up to four (4) HD HDMI monitors.



---

## Configuration guide

For information on the possible display wall setups, see the Matrox QuadHead2Go Configuration Guide ([www.matrox.com/quadhead2go/support](http://www.matrox.com/quadhead2go/support)).

---

## Before you begin

We recommend you have the following:

- DHCP (Dynamic Host Configuration Protocol) server
- DNS (Domain Name System) server

---

# Installing your QuadHead2Go card

This section describes how to install your Matrox card. If your Matrox card is already installed in your system, skip to [“Connecting your QuadHead2Go Q185 card”](#), page 12 or [“Connecting your QuadHead2Go Q155 card”](#), page 15. For information specific to your system, like how to remove its cover, see your system manual.

---

## Before you begin

To avoid personal injury and to prevent damage to your system or Matrox hardware, read the following guidelines before installing and connecting your Matrox hardware.

### Preventing damage to your hardware

- While your system is turned off but still plugged in, some electrical current is supplied to the motherboard. This current may prevent newly installed hardware from working properly. Always try to insert or remove your card as straight as possible.
- Whenever you change your connection setup, make sure you’re using the correct connectors and that all connectors are properly fastened.
- When connecting devices, make sure the connectors are properly fastened.
- Review the safety information provided. For more information, see [“Matrox safety information”](#), page 5.

---

## Step-by-step installation

### 1 Choose an expansion slot

Most systems have different types of expansion slots. Choose a PCI Express® (PCIe®) slot. Your system manual should identify the location of each type of expansion slot in your system.

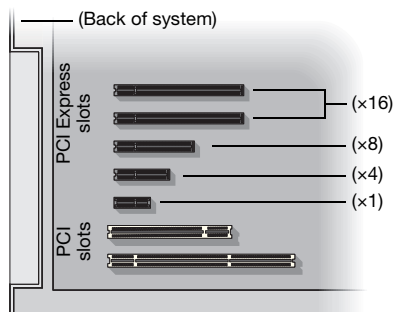

## 2 Insert your Matrox card

- a Position your Matrox card over the expansion slot you've chosen.
- b Push the card in firmly and evenly until it's fully seated in the slot.
- c Secure the bracket of your Matrox card to the frame of your system.

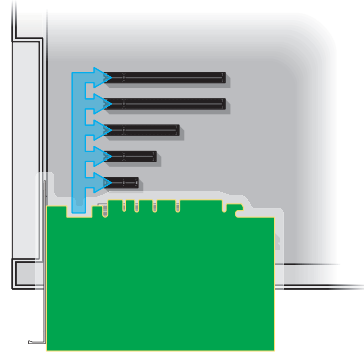

Your Matrox card is now installed. If you're installing more than one card, see “Installing multiple cards”, page 11. *Before restarting your system*, connect your devices (see “Connecting your QuadHead2Go Q185 card”, page 12 or “Connecting your QuadHead2Go Q155 card”, page 15). *After connecting*, restart your system and install your Matrox software.

---

## Installing multiple cards

Your system may support the installation of multiple QuadHead2Go cards in your system.



**WARNING:** To avoid damaging your cards, always insert your card as straight as possible into the slot. Don't rock the card from side to side. If you meet resistance, don't force the card into the slot.

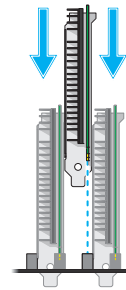

---

# Connecting your QuadHead2Go Q185 card

This section describes how to connect your Matrox QuadHead2Go Q185 card.

---

## Before you begin

To avoid possible problems that could damage your monitors or prevent you from using your Matrox product, read the following guidelines before connecting your devices.

- Whenever you change your connection setup, make sure you're using the correct connectors and that all connectors are properly fastened.
- Review the safety information provided. For more information, see [“Matrox safety information”](#), page 5.

---

## Connection overview

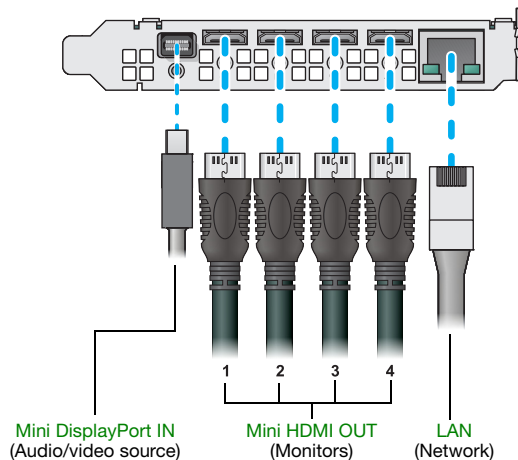

## Description of supported connectors

Connector	Description
<b>Mini DisplayPort IN</b>	Connect your mini DisplayPort cable to your Matrox card. Connect the other end of the cable to your audio/video source.
<b>Mini HDMI OUT</b>	Connect a digital monitor to this connector.
<b>LAN</b>	Connect a network cable to this connector.



**Note:** To connect to the bracket of your Matrox product, the overmold (or boot) of the mini HDMI connectors must respect the maximum width (0.551 inches/14 mm) and thickness (0.331 inches/8.4 mm) stated in the HDMI specifications.

For the mini HDMI connectors, we recommend you use certified HDMI cables that support your maximum resolution.

## Step-by-step connection setup

This section guides you through the step-by-step connection setup of your QuadHead2Go card. For more information on connectors, see “Description of supported connectors”, page 13.

### 1 Connect your DisplayPort source

Connect your DisplayPort source to the mini DisplayPort connector on your QuadHead2Go card.

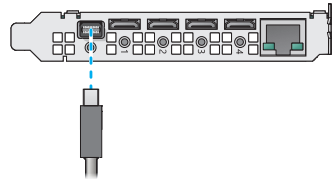

### 2 Connect your digital monitors

Connect your monitors to the mini HDMI connectors on your QuadHead2Go card.

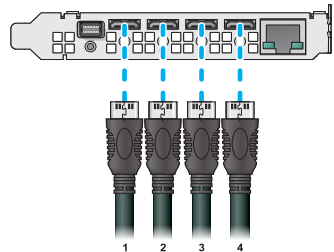

### 3 Connect to your network

Connect a network cable to the RJ-45 connector on your QuadHead2Go card.

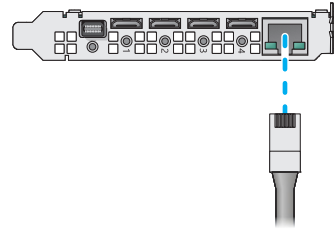

After connecting your QuadHead2Go card, validate your connection setup (see [“Validating your QuadHead2Go setup”](#), page 25).

---

# Connecting your QuadHead2Go Q155 card

This section describes how to connect your Matrox QuadHead2Go Q155 card.

---

## Before you begin

To avoid possible problems that could damage your monitors or prevent you from using your Matrox product, read the following guidelines before connecting your devices.

- Whenever you change your connection setup, make sure you're using the correct connectors and that all connectors are properly fastened.
- Review the safety information provided. For more information, see [“Matrox safety information”](#), page 5.

---

## Connection overview

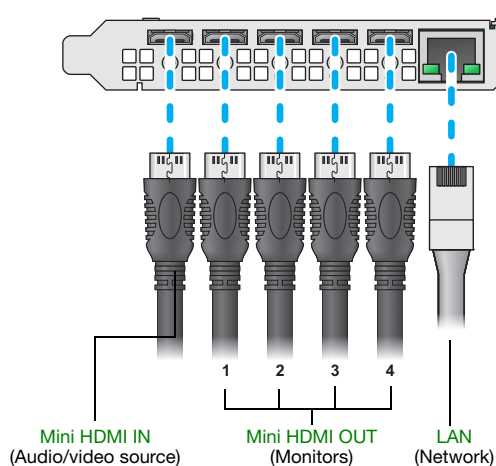

## Description of supported connectors

Connector	Description
<b>Mini HDMI IN</b>	Connect your mini HDMI cable to your Matrox card. Connect the other end of the cable to your audio/video source.
<b>Mini HDMI OUT</b>	Connect a digital monitor to this connector.
<b>LAN</b>	Connect a network cable to this connector.



**Note:** To connect to the bracket of your Matrox product, the overmold (or boot) of the mini HDMI connectors must respect the maximum width (0.551 inches/14 mm) and thickness (0.331 inches/8.4 mm) stated in the HDMI specifications.

For the mini HDMI connectors, we recommend you use certified HDMI cables that support your maximum resolution.

## Step-by-step connection setup

This section guides you through the step-by-step connection setup of your QuadHead2Go card. For more information on connectors, see [“Description of supported connectors”](#), page 16.

### 1 Connect your HDMI source

Connect your HDMI source to the mini HDMI connector on your QuadHead2Go card.

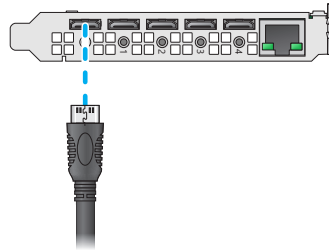

### 2 Connect your digital monitors

Connect your monitors to the mini HDMI connectors on your QuadHead2Go card.

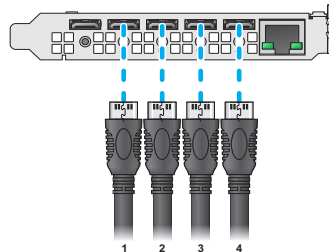



### 3 Connect to your network

Connect a network cable to the RJ-45 connector on your QuadHead2Go card.

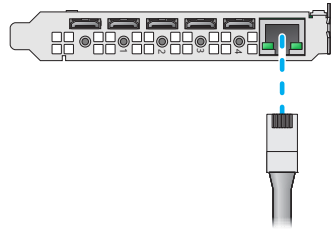

After connecting your QuadHead2Go card, validate your connection setup (see [“Validating your QuadHead2Go setup”](#), page 25).

---

# Connecting your QuadHead2Go Q185 unit

This section describes how to connect your Matrox QuadHead2Go Q185 unit.

---

## Before you begin

To avoid possible problems that could damage your monitors or prevent you from using your Matrox product, read the following guidelines before connecting your devices.

- Whenever you change your connection setup, make sure you're using the correct connectors and that all connectors are properly fastened.
- Review the safety information provided. For more information, see [“Matrox safety information”](#), page 5.

---

## Connection overview

### QuadHead2Go Q185 – Back

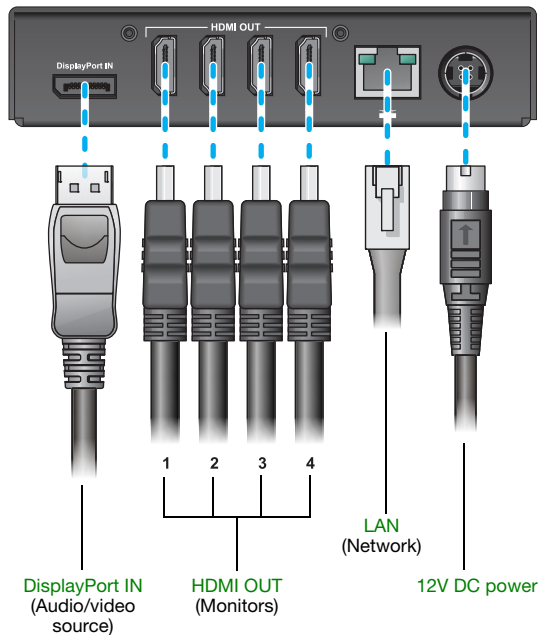

## Description of connectors

Connector	Description
<b>12V DC power</b>	Connect the 12V DC power supply included with your product to this connector. While the power supply is connected to the device and electrical socket, the power LED ( $\phi$ ) is active (not black). For more information on LEDs, see “Description of status LEDs”, page 25.
<b>DisplayPort IN</b>	Connect your DisplayPort cable to your Matrox unit. Connect the other end of the cable to your audio/video source.
<b>HDMI OUT</b>	Connect a digital monitor to this connector.
<b>LAN</b>	Connect a network cable to this connector.



**Note:** To connect your monitors, the overmold (or boot) of the HDMI connectors must respect the maximum width (0.823 inches/20.9 mm) and thickness (0.452 inches/11.5 mm) stated in the HDMI specifications.

For the HDMI connectors, we recommend you use certified HDMI cables that support your maximum resolution.

## Step-by-step connection setup

This section guides you through the step-by-step connection setup of your QuadHead2Go unit. For more information on connectors, see “Description of connectors”, page 19.

### 1 Connect your DisplayPort source

Connect your DisplayPort source to the **DisplayPort IN** connector on your QuadHead2Go unit.

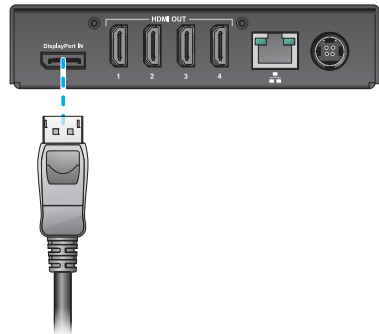



**WARNING:** To avoid damaging the DisplayPort connector on your DisplayPort monitor cable or on your Matrox product, carefully remove the DisplayPort cable by pressing the latch on the top of the DisplayPort connector while removing the connector.

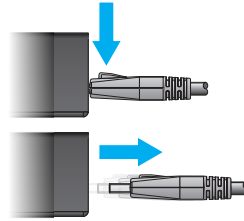

## 2 Connect your digital monitors

Connect your monitors to the **HDMI OUT** connectors on your QuadHead2Go unit.

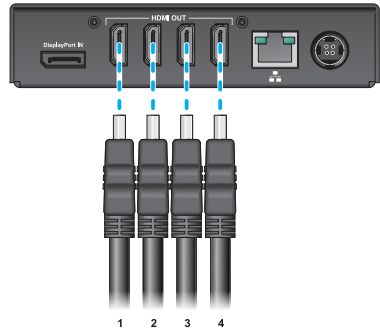

## 3 Connect to your network

Connect a network cable to the **LAN** (  ) connector on your QuadHead2Go unit.

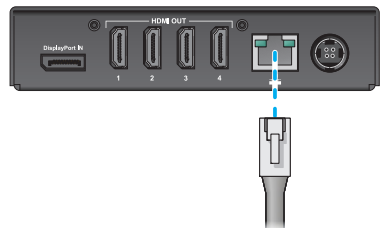

## 4 Connect your power supply

Connect the 12V power supply included with your product to the **12V** connector on the QuadHead2Go unit.

While the power supply is connected to the unit and electrical socket, the power LED (  ) is active (not black).

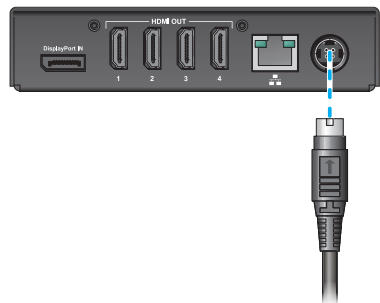

For more information on LEDs, see “Description of status LEDs”, page 25.



**WARNING:** To avoid damaging the power connector on your device or on your power cable when unplugging a unit, firmly hold the power connector, pull back the connector on the cable, then carefully remove the power cable.

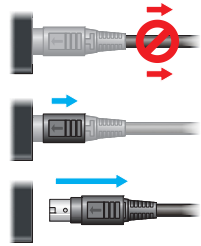

After connecting your QuadHead2Go unit, validate your connection setup (see “Validating your QuadHead2Go setup”, page 25).

---

# Connecting your QuadHead2Go Q155 unit

This section describes how to connect your Matrox QuadHead2Go Q155 unit.

---

## Before you begin

To avoid possible problems that could damage your monitors or prevent you from using your Matrox product, read the following guidelines before connecting your devices.

- Whenever you change your connection setup, make sure you're using the correct connectors and that all connectors are properly fastened.
- Review the safety information provided. For more information, see [“Matrox safety information”](#), page 5.

---

## Connection overview

### QuadHead2Go Q155 – Back

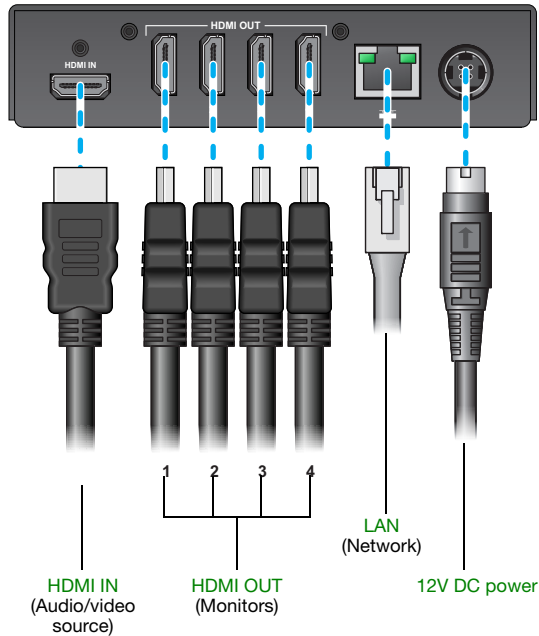

---

## Description of connectors

Connector	Description
<b>12V DC power</b>	Connect the 12V DC power supply included with your product to this connector. While the 12V DC power supply is connected to the device and electrical socket, the power LED (  ) is active (not black). For more information on LEDs, see “Description of status LEDs”, page 25.
<b>HDMI IN</b>	Connect your HDMI cable to your Matrox unit. Connect the other end of the cable to your audio/video source.
<b>HDMI OUT</b>	Connect a digital monitor to this connector.
<b>LAN</b>	Connect a network cable to this connector.



**Note:** To connect your monitors, the overmold (or boot) of the HDMI connectors must respect the maximum width (0.823 inches/20.9 mm) and thickness (0.452 inches/11.5 mm) stated in the HDMI specifications.

For the HDMI connectors, we recommend you use certified HDMI cables that support your maximum resolution.

---

## Step-by-step connection setup

This section guides you through the step-by-step connection setup of your QuadHead2Go unit. For more information on connectors, see “Description of connectors”, page 23.

### 1 Connect your HDMI source

Connect your HDMI source to the **HDMI IN** connector on your QuadHead2Go unit.

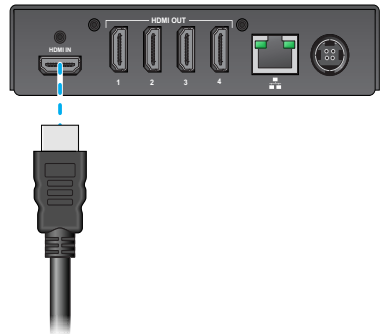

## 2 Connect your digital monitors

Connect your monitors to the **HDMI OUT** connectors on your QuadHead2Go unit.

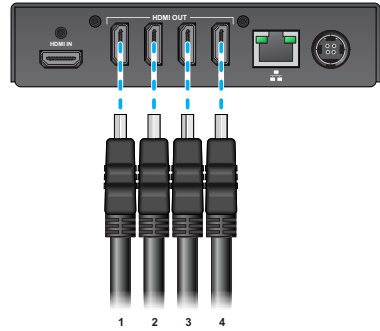

## 3 Connect to your network

Connect a network cable to the **LAN** (  ) connector on your QuadHead2Go unit.

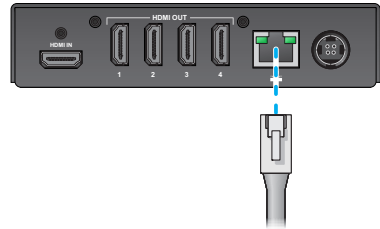

## 4 Connect your power supply

Connect the 12V power supply included with your product to the **12V** connector on the QuadHead2Go unit. While the power supply is connected to the unit and electrical socket, the power LED (  ) is active (not black).

For more information on LEDs, see [“Description of status LEDs”, page 25](#).

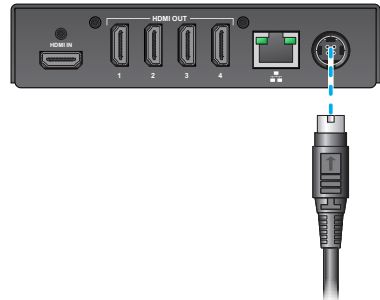

**WARNING:** To avoid damaging the power connector on your device or on your power cable when unplugging a unit, firmly hold the power connector, pull back the connector on the cable, then carefully remove the power cable.

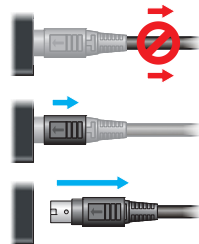

After connecting your QuadHead2Go unit, validate your connection setup (see [“Validating your QuadHead2Go setup”, page 25](#)).



---

# Validating your QuadHead2Go setup

After connecting your QuadHead2Go Series products, we recommend you validate your connection setup and network discovery before you continue.

---

## Connection checklist

Validate the connections for your QuadHead2Go Series product:

- See “Connecting your QuadHead2Go Q185 card” on page 12.
- See “Connecting your QuadHead2Go Q155 card” on page 15.
- See “Connecting your QuadHead2Go Q185 unit” on page 18.
- See “Connecting your QuadHead2Go Q155 unit” on page 22.

---

## Description of status LEDs

The LEDs on your QuadHead2Go products provides information to help you troubleshoot your Matrox product. The following describes the LED on your QuadHead2Go products.

### QuadHead2Go unit

The two LEDs at the front of your QuadHead2Go unit provide power and status information.



**Note:** If LED B turns to red when a button is pressed on your QuadHead2Go unit, the buttons on your unit are disabled. For more information, see “Using control buttons on your QuadHead2Go device”.



LED color	A	B
No LED (black)	Device isn't powered.	—
Green (solid)	Device is active.	Device is active. No errors.
Green (slow blink)	Device is rebooting.	Input or output signal doesn't match configuration.
Green (fast blink)	Device is selected. ( <i>I-am-here</i> feature.)	—
Amber (solid)	Firmware update in progress.	No input signal detected.
Amber (slow blink)	No network detected.	Firmware update in progress.
Red (solid)	Device has detected a fatal error. Try powering your device off and on. If, after restarting your device, the LEDs are still red, contact your vendor for technical support (see "Customer support", page 46).	

## Network connector

The network connectors on your QuadHead2Go products use LEDs to provide information on the network activity and presence. The following describes the different network connector LEDs.

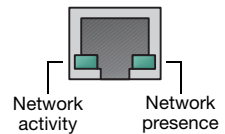

LED color	Network activity	Network presence
No LED (black)	No network activity detected.	—
Green (fast blink)	Network activity detected.	—
Green	—	1 Gbps

## Validating network discovery

QuadHead2Go Series devices are initially assigned their IP addresses through DHCP (Dynamic Host Control Protocol). After connecting your devices, we recommend verifying that all of your devices are discovered by the network. For more information, contact your network administrator.

## Multiple subnet support

QuadHead2Go Series devices that are in the same subnet are detected through the UPnP (Universal Plug and Play) protocol. If your devices are in different network subnets, you need to validate network discovery in each subnet separately. For more information on using different subnets, contact your network administrator.

After validating your connection setup, install your software.

---

# Updating your Matrox QuadHead2Go firmware

The Matrox QuadHead2Go Firmware Updater enables you to update the firmware and install the default layouts of your Matrox QuadHead2Go products.



**Note:** Your Matrox QuadHead2Go product may ship with an older firmware version. Before using your QuadHead2Go product, you must update the firmware version installed on your devices to use the version of your deployed release.

---

## Supported operating systems

The Matrox QuadHead2Go Firmware Updater supports the following operating systems:

- Windows® Server® 2019
- Windows® Server® 2016
- Windows® 10 (64-bit)
- Linux (tested with Ubuntu 14.04 and Mono 5.12)

---

## Obtaining the Matrox QuadHead2Go firmware updater package

- Matrox makes the latest firmware and updater package for your QuadHead2Go products available on the Matrox web site ([www.matrox.com/QuadHead2Go/support](http://www.matrox.com/QuadHead2Go/support)).
- Download the latest firmware package and extract the files to a local folder on your system (for example, *C:\QuadHead2GoFirmwareUpdate*).

---

## Before you update your firmware

Before you update the firmware on your QuadHead2Go devices, read the following guidelines:

- Make sure you have at least 1 GB of free disk space available.
- To avoid possible problems with your QuadHead2Go devices, we recommend running only one instance of the QuadHead2Go firmware updater on your network at a time.

- Make sure you have a DHCP (Dynamic Host Configuration Protocol) server on an established network. The firmware updater requires constant IP addresses to update the devices properly. As the firmware updater requires a device to reboot multiple times, make sure your DHCP server maintains the IP address of a device when it reappears on the network. Otherwise, we recommend assigning fixed IP addresses to your devices.
- If your system doesn't have access to a DNS server, configure your system to use a fixed IP address (such as local host – 127.0.0.1) as its DNS server. Otherwise, the firmware update process may take a long time to complete.

---

## Step-by-step instructions

### 1 Run the QuadHead2Go Firmware Updater

Browse to the folder containing the extracted files, then run the *UpdaterUI.exe* file. This opens the QuadHead2Go Firmware Updater.

### 2 Search for available QuadHead2Go devices

**Automatic detection** – To search for the QuadHead2Go devices on your subnet, select **Automatic detection**.

To start searching for devices, click **Search**.

**Manual detection** – If devices aren't automatically detected, you can manually locate one or more QuadHead2Go devices using their IP address. To manually locate the devices, select **Manual detection**, and under **Address or URL** enter the IP address of each QuadHead2Go device you want to locate.

**1** Search for devices

Automatic detection  
 Manual detection

Address or URL:  ...

Search

**1** Search for devices

Automatic detection  
 Manual detection

Address or URL:  ...

Search

If you're entering multiple addresses, separate each address with a space. (You can also enter the IP addresses by clicking the browse button (  ) and entering one IP address per line.)

When you're done entering the IP addresses, click **Apply**. To discard the last changes made, click **Cancel**.

To start searching for devices, click **Search**.

To stop searching for devices, click **Stop**. To resume searching for devices, click **Search** again.

IP addresses

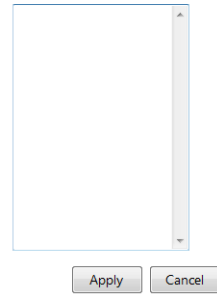

### 3 Select the devices to update

Select the devices you want to update. Devices with an older firmware version are automatically selected.

To change the sort order of the device tiles, right-click the device list box, select **Sort by** and the sorting order to use. To deselect all items, right-click the device list box and select **Unselect all devices**.

### 4 Update the firmware

When you're done adding QuadHead2Go devices to the list of devices you want to update, click **Update**.

Wait while the devices are being updated. Updating devices may take up to 10 minutes.

---

# Matrox PowerWall software



Matrox® PowerWall™ software is available for Matrox QuadHead2Go™ multi-monitor controllers to simplify video wall designs and installations of your QuadHead2Go devices. The software works in offline mode to customize configurations of any type and size without the need for an active connection to a QuadHead2Go. Configurations are then uploaded to your physical devices.

As well as being able to configure your input and outputs resolution, you can also:

- Rotate each output independently of the others in 90-degree increments – 90, 180, and 270 degrees – for artistic video wall configurations.
- Control and fine-tune bezels using pre-set images to ensure seamless image displays.
- Optimize visuals by cropping, upscaling, or downscaling the content as desired.

This section describes how to install and use Matrox PowerWall software for *Windows® Server® 2016*, *Windows® 10 Standard (64-bit)*, *Windows® 10 Professional (64-bit)*, *Windows® 10 Enterprise (64-bit)*, and *Windows® 10 IoT*.

---

## Before you begin

- You may need administrator rights to install or uninstall certain software. For more information, see Windows documentation or contact your system administrator.
- To assign an initial IP address to your devices, a DHCP (Dynamic Host Configuration Protocol) server is recommended.

---

## Obtaining Matrox PowerWall software

Matrox makes the latest PowerWall software available on the Matrox web site ([www.matrox.com/QuadHead2Go/support](http://www.matrox.com/QuadHead2Go/support)).

---

## Installing your software

To install the software for your QuadHead2Go product, run the installation program for your software package. Follow the on-screen instructions.

---

## Accessing Matrox PowerWall software

To access PowerWall, click **Start** → **All apps\*** → **Matrox PowerWall \*** → **Matrox PowerWall**.  
(\* Depending on your configuration of Windows, this part may not be necessary.)

---

## Running Matrox PowerWall

When PowerWall starts for the first time, a blank design is created. A design contains the devices in your video wall and their settings. To create a design, you add and remove devices. These devices are virtual because their settings aren't directly linked to a physical device.

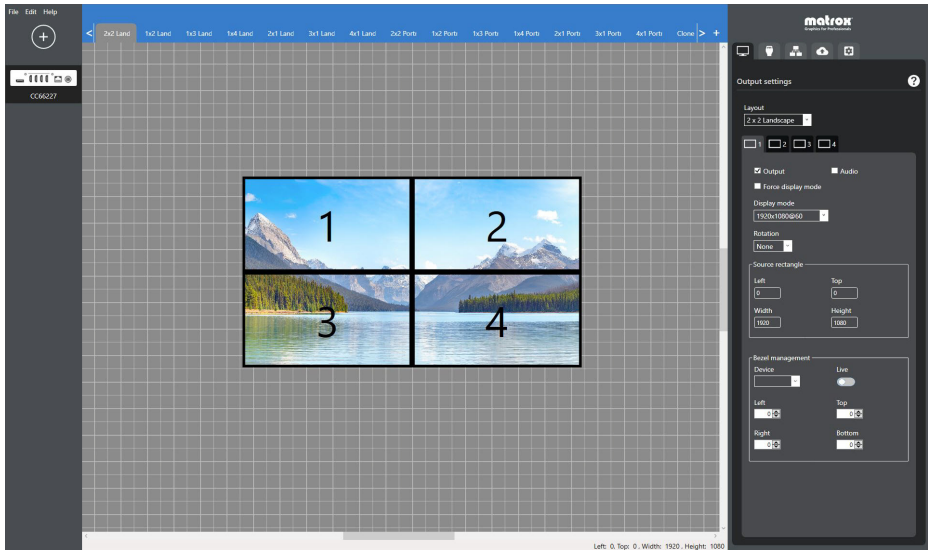

To set up your display wall design:

- Add or remove devices from your display wall.
- Define different layouts for the outputs of your devices using the canvas and the device output settings.
- Select the input resolution of your device.
- Define the network settings of your device.
- Upload the configurations of the devices in your design to your physical QuadHead2Go devices.

---

## More information

For more information on PowerWall software, see the help file included with your PowerWall software.

# Using control buttons on your QuadHead2Go device

You can use the control buttons at the front of your QuadHead2Go unit and in the upper left corner on your QuadHead2Go card to select the source image, select your layout, or view information about your device.

## *QuadHead2Go unit*

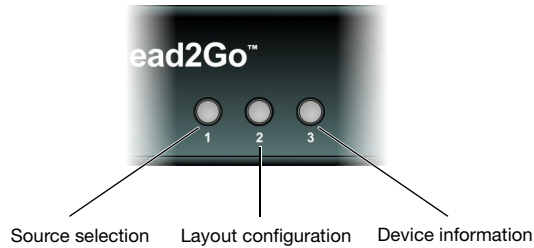

## *QuadHead2Go card*

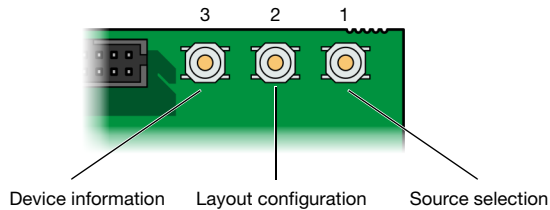

Press a control button once to view its corresponding on-screen menu. Press the button again to cycle through the menu options. Stop pressing the button to apply the current selection.



**Note:** If LED B (right) turns to red when a button is pressed on your QuadHead2Go unit, the buttons on your unit are disabled. For more information, see [“Description of status LEDs”](#).



Button	Function
<b>1</b> <b>(Source selection)</b>	Select your input source. The following are possible input sources: <ul style="list-style-type: none"> <li>▪ Video input</li> <li>▪ Logo</li> <li>▪ Nature background</li> <li>▪ Bezel adjustment grid</li> <li>▪ Red</li> <li>▪ Green</li> <li>▪ Blue</li> <li>▪ Gray gradient</li> </ul>
<b>2</b> <b>(Layout configuration)</b>	Select your layout. The selected layout is highlighted in the list. The available layouts depend on your firmware package and can be modified through Matrox PowerWall or the QuadHead2Go REST API.
<b>3</b> <b>(Device information)</b>	Shows the device information such as: <ul style="list-style-type: none"> <li>▪ Output ID (1, 2, 3, or 4).</li> <li>▪ Model number.</li> <li>▪ IP address.</li> <li>▪ MAC address.</li> <li>▪ If IP addressing is dynamic (DHCP) or static.</li> <li>▪ Active layout.</li> <li>▪ Input mode.</li> <li>▪ Output mode.</li> <li>▪ If bezel management is enabled.</li> <li>▪ If HDCP is enabled.</li> <li>▪ If there is an input mismatch between the configuration and the actual signal.</li> <li>▪ If there is an output mismatch between the configuration and the actual display mode.</li> <li>▪ If the physical buttons on your device have been disabled.</li> <li>▪ Serial number.</li> <li>▪ Firmware version.</li> <li>▪ FPGA version.</li> </ul>
<b>1 and 2</b> <b>(Re-enable buttons)</b>	If the physical buttons on your device have been disabled, press and hold buttons 1 and 2 for 20 seconds to re-enable them.
<b>1 and 3</b> <b>(Device reset)</b>	Press and hold buttons 1 and 3 for five seconds to reset your device to its factory default settings.

# Product information

## Specifications

### QuadHead2Go Q185 card

	QuadHead2Go Q185
<b>Operating systems supported</b>	–
<b>Product type</b>	PCIe card (x1 electrical, x16 mechanical – power only)
<b>Form factor</b>	Full height
<b>Memory</b>	1 GB
<b>Audio/Video input connectors</b>	1× Mini DisplayPort 1.2
<b>Audio/Video output connectors</b>	4× Mini HDMI Type C (with 16-bit stereo L-PCM audio)
<b>Networking interface</b>	1× 100/1000 Base-T RJ45 Ethernet Port, auto-speed, half/full duplex
<b>Color sampling and conversion</b>	RGB: 8:8:8 (24-bit) YUV: 4:4:4, 4:2:2 (8-bit)
<b>HDCP support</b>	✓
<b>Command protocols</b>	UPnP, HTTPS
<b>Supported maximum input resolutions* (DisplayPort video input)</b>	3840 × 2160 @ 60 Hz, 3840 × 2160 @ 30 Hz, 7680 × 1080 @60Hz, 7680 × 1080 @30Hz, 1920 × 4320 @60Hz, 1920 × 4320 @30Hz
<b>Supported maximum output resolutions* (HDMI video output)†‡</b>	1920 × 1080 @60Hz, 1920 × 1080 @30Hz, 1920 × 1200 @60Hz, 1920 × 1200 @30Hz
<b>Power consumption</b>	15W
<b>Dimensions</b>	2.16 cm × 12.70 cm × 15.77 cm / 0.85 inches × 5.00 inches × 6.21 inches
<b>Regulatory compliance</b>	Class A: RCM, CE, FCC, KC

\* Custom resolutions are also supported. Please contact Matrox for more details.

† When using a display resolution equal to or higher than 1280×720p60, we recommend you use certified HDMI cables that support your maximum resolution.

‡ Unless specified, modes are p60 (progressive 60 Hz).

## QuadHead2Go Q155 card

	QuadHead2Go Q155
<b>Operating systems supported</b>	–
<b>Product type</b>	PCIe card (x1 electrical, x16 mechanical – power only)
<b>Form factor</b>	Full height
<b>Memory</b>	1 GB
<b>Audio/Video input connectors</b>	1× Mini HDMI
<b>Audio/Video output connectors</b>	4× Mini HDMI Type C (with 16-bit stereo L-PCM audio)
<b>Networking interface</b>	1× 100/1000 Base-T RJ45 Ethernet Port, auto-speed, half/full duplex
<b>Color sampling and conversion</b>	RGB: 8:8:8 (24-bit) YUV: 4:4:4, 4:2:2, 4:2:0 (8-bit)
<b>HDCP support</b>	✓
<b>Command protocols</b>	UPnP, HTTPS
<b>Supported maximum input resolutions * (DisplayPort video input)</b>	3840 × 2160 @ 60 Hz, 3840 × 2160 @ 30 Hz, 7680 × 1080 @60Hz, 7680 × 1080 @30Hz, 1920 × 4320 @60Hz, 1920 × 4320 @30Hz
<b>Supported maximum output resolutions * (HDMI video output)†‡</b>	1920 × 1080 @60Hz, 1920 × 1080 @30Hz, 1920 × 1200 @60Hz, 1920 × 1200 @30Hz
<b>Power consumption</b>	15W
<b>Dimensions</b>	2.16 cm × 12.70 cm × 15.77 cm / 0.85 inches × 5.00 inches × 6.21 inches
<b>Regulatory compliance</b>	Class A: RCM, CE, FCC, KC

\* Custom resolutions are also supported. Please contact Matrox for more details. We recommend you use certified HDMI cables that support your maximum resolution.

† When using a display resolution equal to or higher than 1280×720p60, we recommend you use certified HDMI cables that support your maximum resolution.

‡ Unless specified, modes are p60 (progressive 60 Hz).

## QuadHead2Go Q185 unit

	QuadHead2Go Q185
<b>Operating systems supported</b>	–
<b>Product type</b>	Standalone appliance
<b>Form factor</b>	1 RU, third width
<b>System memory</b>	1 GB
<b>Audio/Video input connectors</b>	1× DisplayPort 1.2
<b>Audio/Video output connectors</b>	4× HDMI Type A (with 16-bit stereo L-PCM audio)
<b>Networking interface</b>	1× 100/1000 Base-T RJ45 Ethernet Port, auto-speed, half/full duplex
<b>Color sampling and conversion</b>	RGB: 8:8:8 (24-bit) YUV: 4:4:4, 4:2:2 (8-bit)
<b>HDCP support</b>	✓
<b>Command protocols</b>	UPnP, HTTPS
<b>Supported maximum input resolutions * (DisplayPort video input)</b>	3840 × 2160 @ 60 Hz, 3840 × 2160 @ 30 Hz, 7680 × 1080 @60Hz, 7680 × 1080 @30Hz, 1920 × 4320 @60Hz, 1920 × 4320 @30Hz
<b>Supported maximum output resolutions * (HDMI video output)†‡</b>	1920 × 1080 @60Hz, 1920 × 1080 @30Hz, 1920 × 1200 @60Hz, 1920 × 1200 @30Hz
<b>Power connector§</b>	DIN 4 female (4-pin)
<b>Power consumption</b>	24W
<b>Dimensions</b>	13.97 cm × 3.18 cm × 18.11 cm / 5.50 inches × 1.25 inches × 7.13 inches
<b>Regulatory compliance</b>	Class A: RCM, CE, FCC, KC

\* Custom resolutions are also supported. Please contact Matrox for more details.

† When using a display resolution equal to or higher than 1280×720p60, we recommend you use certified HDMI cables that support your maximum resolution.

‡ Unless specified, modes are p60 (progressive 60 Hz).

§ Only use the power supply originally supplied by Matrox with your Matrox QuadHead2Go product.

## QuadHead2Go Q155 unit

	QuadHead2Go Q155
<b>Operating systems supported</b>	–
<b>Product type</b>	Standalone appliance
<b>Form factor</b>	1 RU, third width
<b>System memory</b>	1 GB
<b>Audio/Video input connectors</b>	1× HDMI
<b>Audio/Video output connectors</b>	4× HDMI Type A (with 16-bit stereo L-PCM audio)
<b>Networking interface</b>	1× 100/1000 Base-T RJ45 Ethernet Port, auto-speed, half/full duplex
<b>Color sampling and conversion</b>	RGB: 8:8:8 (24-bit) YUV: 4:4:4, 4:2:2, 4:2:0 (8-bit)
<b>HDCP support</b>	✓
<b>Command protocols</b>	UPnP, HTTPS
<b>Supported maximum input resolutions * (DisplayPort video input)</b>	3840 × 2160 @ 60 Hz, 3840 × 2160 @ 30 Hz, 7680 × 1080 @60Hz, 7680 × 1080 @30Hz, 1920 × 4320 @60Hz, 1920 × 4320 @30Hz
<b>Supported maximum output resolutions * (HDMI video output)†‡</b>	1920 × 1080 @60Hz, 1920 × 1080 @30Hz, 1920 × 1200 @60Hz, 1920 × 1200 @30Hz
<b>Power connector§</b>	DIN 4 female (4-pin)
<b>Power consumption</b>	24W
<b>Dimensions</b>	13.97 cm × 3.18 cm × 18.11 cm / 5.50 inches × 1.25 inches × 7.13 inches
<b>Regulatory compliance</b>	Class A: RCM, CE, FCC, KC

\* Custom resolutions are also supported. Please contact Matrox for more details. We recommend you use certified HDMI cables that support your maximum resolution.

† When using a display resolution equal to or higher than 1280×720p60, we recommend you use certified HDMI cables that support your maximum resolution.

‡ Unless specified, modes are p60 (progressive 60 Hz).

§ Only use the power supply originally supplied by Matrox with your Matrox QuadHead2Go product.

---

## External power supply

<b>Input AC voltage range</b>	100V to 240V AC
<b>Input frequency</b>	50 to 60 Hz
<b>Input connector</b>	IEC 60320-C14
<b>Output voltage</b>	12V DC, 3.5A
<b>Output connector</b>	DIN 4 male (4-pin) with lock
<b>Maximum power</b>	42W



**Note:** Only use the power supply originally supplied by Matrox with your Matrox QuadHead2Go product.

---

## Environmental

<b>Temperature, operational</b>	0 to 45 °C (32 to 113 °F)
<b>Temperature, non-operational storage and transportation</b>	-40 to 70 °C (-40 to 158 °F)
<b>Humidity, operational (indoor)</b>	20% to 80% (non-condensing)
<b>Humidity, non-operational storage and transportation</b>	5% to 95% (non-condensing)
<b>Atmospheric pressure, operational</b>	660hPa (3,000 meters / 9,842 feet) to 1013hPa (0 meters / 0 feet)
<b>Atmospheric pressure, non-operational and transportation</b>	192hPa (12,000 meters / 39,370 feet) to 1020hPa (-50 meters / -164 feet)

# Appendix A – Matrox secure cable solution

## QuadHead2Go card

### Mini DisplayPort™

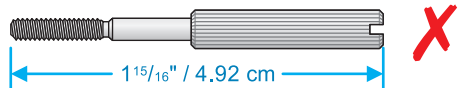
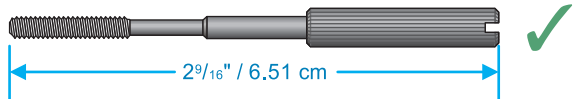
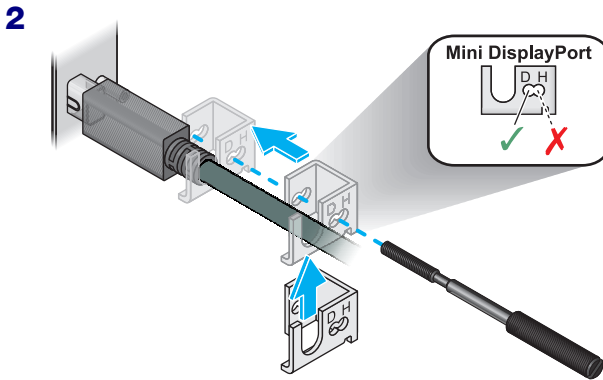
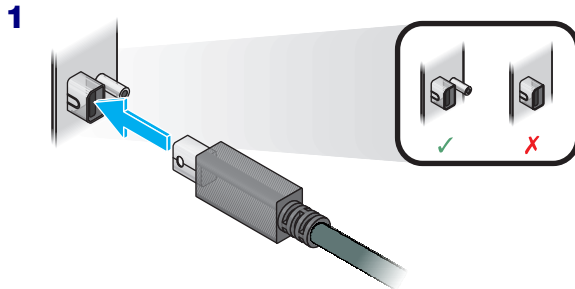

# Mini HDMI®

1

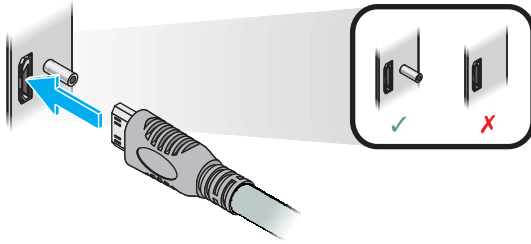

2

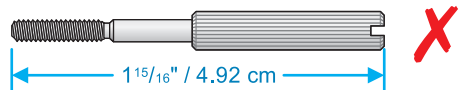
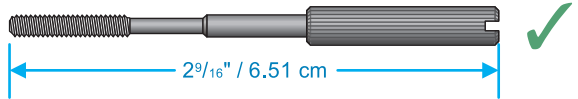
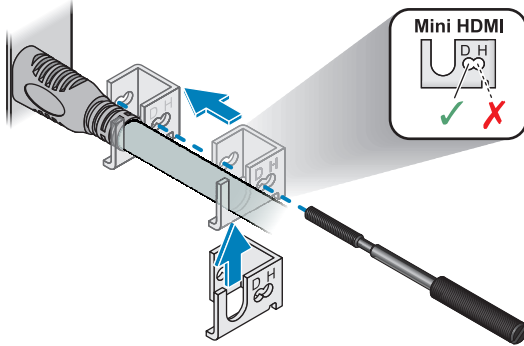



---

## QuadHead2Go unit

1

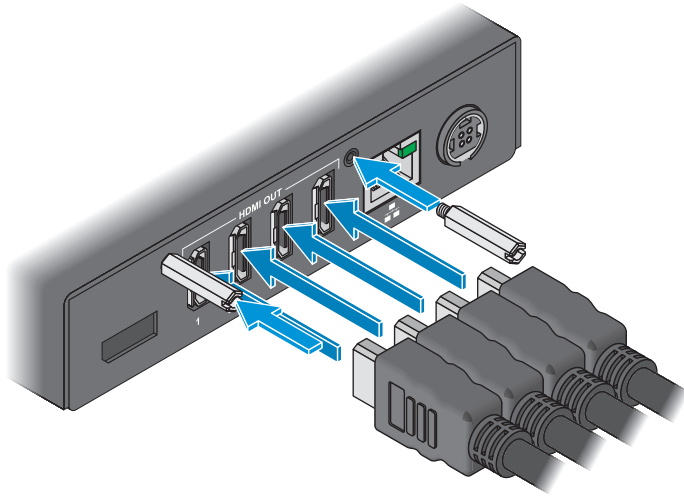

2

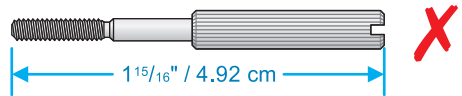
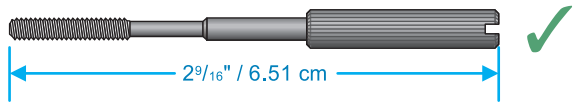
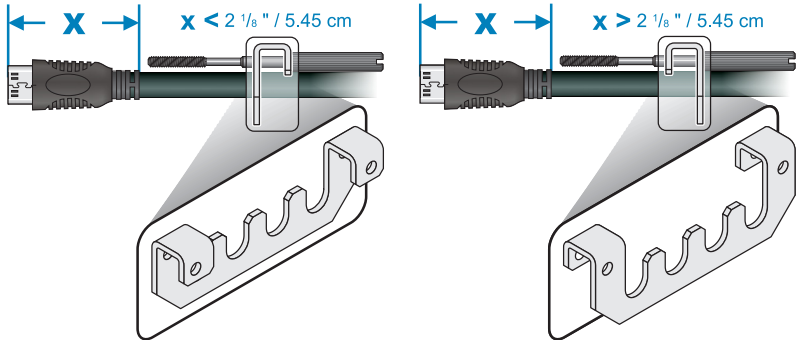
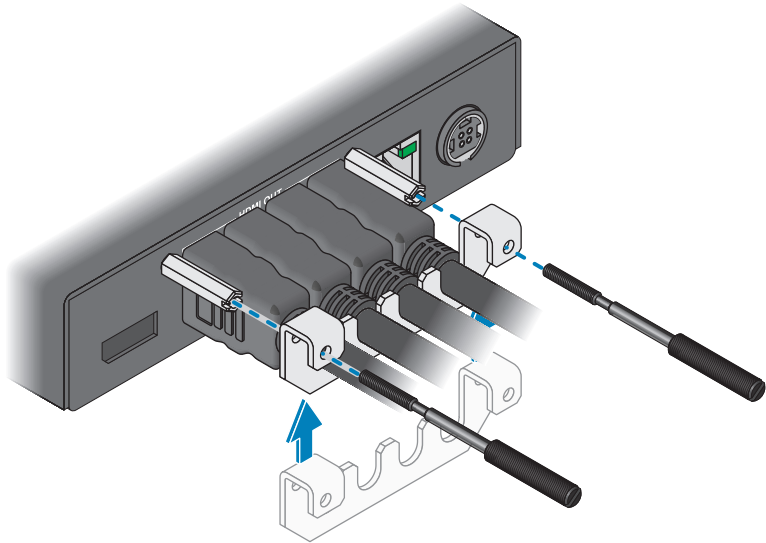

---

# Appendix B – Mounting your Matrox unit

This section provides guidelines for rack mounting your QuadHead2Go unit.

---

## Mounting guidelines

To prevent damage to your Matrox hardware, read the following guidelines before mounting your Matrox hardware:

- **Mounting shelf only** – To install your mounting shelf, fasten it to the rack as per your rack's instructions. Head screws compatible with most rack mounts are provided.
- **Mounting shelf only** – The mounting shelf has existing holes for your Matrox unit that allow the shelf to be mounted facing forward or backward.
- Use a hand screwdriver to carefully tighten each screw. Make sure to not overtighten the screws.
- Don't stack anything directly over the device.
- Make sure the cables connected to your device are properly secured and that no tension is applied to them.
- Make sure the ambient temperature doesn't exceed the maximum recommended temperatures. For more information, see [“Product information”](#), page 34.

Once your device is mounted, you can connect your system, monitors, and devices to your Matrox device.

## Mounting your QuadHead2Go unit

This section provides guidelines for mounting your QuadHead2Go unit in rack mounts using one or multiple mounting kits available from Matrox.

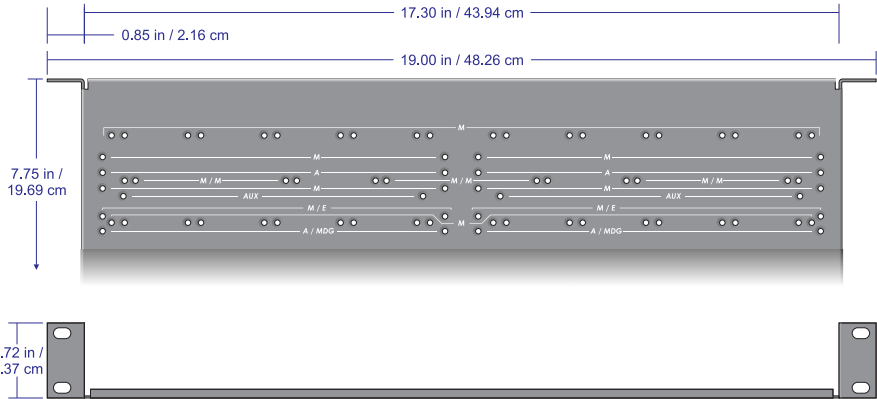

## Mounting your units horizontally

Using the mounting shelf kit in a rack mount, you can mount three (3) QuadHead2Go units horizontally on a single shelf.

- To mount your QuadHead2Go unit, use the holes labeled **M/M**. These holes are 2 inches / 5.08 cm from the front edge of the mounting shelf.
- Your QuadHead2Go unit has two (2) mounting holes under its casing. Use two (2) 6 mm M3 flat-head screws (included in the kit) to secure each unit.

## Mounting your units vertically

Using the mounting shelf kit in a rack mount, you can mount ten (10) QuadHead2Go units vertically on a single shelf.

- Mounting QuadHead2Go units vertically requires the height of a 3U shelf.
- To mount your QuadHead2Go unit vertically, use the holes labeled **M**. These holes are 1.25 inches / 3.18 cm from the front edge of the mounting shelf.
- Your QuadHead2Go unit has two (2) mounting holes on each side. Use two (2) 6 mm M3 flat-head screws (sold separately) to secure each device to the mounting shelf. The holes used to secure the device to the shelf differ depending on which side (left or right) the device is mounted.

## Using your angled bracket kit

You can mount your Matrox units on standard VESA mounts (75, 100, or 200 mm) or on the back of devices with VESA compliant mounting holes.

- To mount your Matrox unit on a VESA mount, you need two (2) angled brackets (included in your angled bracket kit).
- Your Matrox unit has two (2) mounting holes on each side. Use four (4) 6 mm M3 screws (included in your kit) to secure each unit to the angled brackets.
- If a Matrox unit is attached to a VESA mount, no other device can use that VESA mount.

### Mounting to a 75 or 100 mm mounting space

To mount your Matrox unit on a 75 or 100 mm mounting space:

- Attach the brackets to your VESA mount before attaching your brackets to your unit.
- Use two (2) M4 screws (sold separately) inserted through a slot in each bracket to attach your brackets to the mount.
- Use four (4) 6 mm M3 flat-head screws (included in your kit) to attach your brackets to your unit.

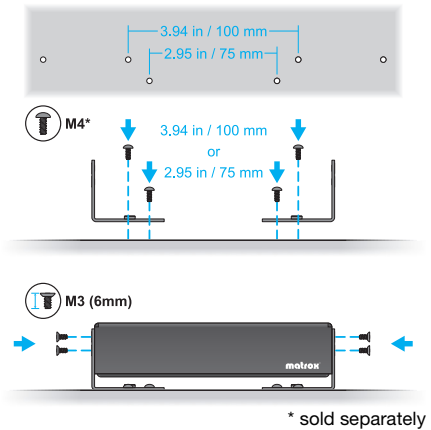

### Mounting to a 200 mm mounting space

To mount your Matrox unit to a 200 mm mounting space:

- Attach your brackets to your unit before attaching to your VESA mount.
- Use four (4) 6 mm M3 pan-head screws (included in your kit) to attach your brackets to your unit.
- Use two (2) M4 screws (sold separately) to attach your brackets to the mount.

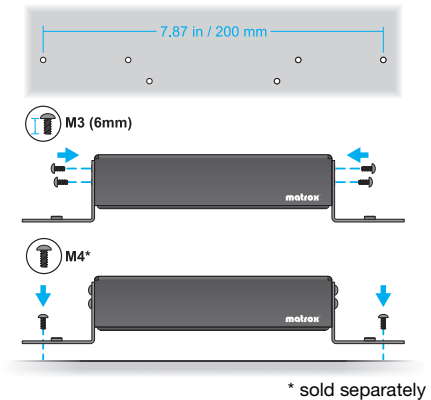

---

# Customer support

---

## Matrox web

Our web site has product literature, press releases, technical material, a sales office list, trade show information, and other relevant material. Visit the Matrox Graphics web site at [www.matrox.com/graphics](http://www.matrox.com/graphics).

---

## Technical support

Matrox values your business and offers professional support for your Matrox product. If you have a problem, we recommend you follow the procedure below for the quickest results.

- 1 Contact your integrator** – This is usually the quickest and most effective method of technical assistance. Your integrator is familiar with your complete system. In the case of hardware warranty assistance, the product must be returned to the integrator, who will return it to Matrox.
- 2 If your Matrox product was provided by your computer manufacturer, contact this manufacturer.** For contact information, see your computer documentation or contact the vendor.
- 3 Direct Matrox technical support** – If you still can't resolve a problem (and your Matrox product wasn't provided by your computer manufacturer), you can get technical assistance by contacting Matrox technical support at [dwcsupport@matrox.com](mailto:dwcsupport@matrox.com).

## Information we need

Please give a complete description of the problem, and include:

- Matrox product serial number, model number, revision number, and firmware version.
- For Matrox cards – driver type and version, and memory address at which the Matrox card is installed.
- Computer brand and model name.
- Monitor brand and model name.
- Operating system, version, and service pack.
- Brand and model of any other cards and devices installed on your system.

## Program specific problems

If a problem appears with a specific program, please give us the following information:

- Display settings (color palette, display resolution, and so on) applied when the problem occurs.
- If possible, take note of the file and segment address that caused the problem.
- Detailed steps known to cause the bug, so we can reproduce it.

---

## Software package download

**From your integrator or manufacturer** – If your product was purchased through an integrator or a manufacturer, contact them for the latest display driver, firmware, software, and system utilities as they're familiar with your complete system. An integrator or a manufacturer may also have directives regarding software updates.

**Directly from Matrox** – A more recent software package may support more features and may offer increased capabilities (such as higher display resolutions). Matrox makes the latest display drivers, firmware, software, and system utilities available on the Matrox Technical Support Web site ([www.matrox.com/graphics/en/support/drivers](http://www.matrox.com/graphics/en/support/drivers)).

---

## View your warranty information

Matrox makes warranty information available on the Matrox site ([www.matrox.com/graphics/en/support/warranty/](http://www.matrox.com/graphics/en/support/warranty/)).

---

## View the third party software notices

Matrox makes third party software notices and/or additional terms and conditions available on the Matrox site (<https://thirdpartylicenses.matrox.com>).

---

## Register your Matrox product

Please register online ([www.matrox.com/graphics/en/registration](http://www.matrox.com/graphics/en/registration)) to receive new product announcements and information on special offers and upcoming events.

---

## USA

---

### **FCC Compliance Statement**

**Remark for the Matrox hardware products supported by this guide** This equipment has been tested and found to comply with the limits for a Class A digital device, pursuant to Part 15 of the FCC Rules. These limits are designed to provide reasonable protection against harmful interference when the equipment is operated in a commercial environment. This equipment generates, uses, and can radiate radio frequency energy and, if not installed and used in accordance with the instructions manual, may cause harmful interference to radio communications. Operation of this equipment in a residential area is likely to cause harmful interference in which case the user will be required to correct the interference at his own expense.

**WARNING** Changes or modifications to this unit not expressly approved by the party responsible for the compliance could void the user's authority to operate this equipment. The use of shielded cables for connection of the monitor to the card is required to meet FCC requirements.

---

## CANADA

---

### **(English) Innovation, Science and Economic Development Canada**

**Remark for the Matrox hardware products supported by this guide** These digital apparatus does not exceed the Class A limits for radio noise emission from digital devices set out in the Radio Interference Regulation of Industry Canada.

### **(Français) Innovation, Sciences et Développement économique Canada**

**Remarque sur les produits matériels Matrox couverts par ce guide** Ce présent appareil numérique n'émet aucun bruit radioélectrique dépassant les limites applicables aux appareils numériques de Classe A prescrites dans le Règlement sur le brouillage radioélectrique édicté par Industrie Canada.

---

## EUROPE

---

### **(English) European user's information – Declaration of Conformity**

**Remark for the Matrox hardware products supported by this guide** These devices comply with EC Directive 2014/30/EU for a Class A digital device. They have been tested and found to comply with EN55032/CISPR32 and EN55024/CISPR24. In a domestic environment these products may cause radio interference in which case the user may be required to take adequate measures. To meet EC requirements, shielded cables must be used to connect the monitor and other peripherals to the card. These products have been tested in a typical class A compliant host system. It is assumed that these products will also achieve compliance in any class A compliant system.



### **(Français) Informations aux utilisateurs Européens – Déclaration de conformité**

**Remarque sur les produits matériels Matrox couverts par ce guide** Ces unités sont conformes à la directive communautaire 2014/30/EU pour les unités numériques de classe A. Les tests effectués ont prouvé qu'elles sont conformes aux normes EN55032/CISPR32 et EN55024/CISPR24. Le fonctionnement de ces produits dans un environnement résidentiel peut causer des interférences radio, dans ce cas l'utilisateur peut être amené à prendre les mesures appropriées. Pour respecter les impératifs communautaires, les câbles de connexion entre le moniteur ou autres périphériques et la carte doivent être blindés. Ces produits ont été testés dans un système hôte typique compatible classe A. On suppose qu'ils présenteront la même compatibilité dans tout système compatible classe A.

### **(Deutsch) Information für europäische Anwender – Konformitätserklärung**

**Anmerkung für die Matrox Hardware-Produktunterstützung durch dieses Handbuch** Diese Geräte entsprechen EC Direktive 2014/30/EU für ein digitales Gerät Klasse A. Sie wurden getestet und entsprechen demnach EN55032/CISPR32 und EN55024/CISPR24. In einer Wohnumgebung können diese Produkte Funkinterferenzen erzeugen, und der Benutzer kann genötigt sein, entsprechende Maßnahmen zu ergreifen. Um EG-Anforderungen zu entsprechen, müssen zum Anschließen des Monitors und anderer Peripheriegeräte an die Karte abgeschirmte Kabel verwendet werden. Diese Produkt wurden in einem typischen, der Klasse A entsprechenden, Host-System getestet. Es wird davon ausgegangen, daß diese Produkte auch in jedem Klasse A entsprechenden System entsprechend funktionieren.



## **(Italiano) Informazioni per gli utenti europei – Dichiarazione di conformità**

**Nota per i prodotti hardware Matrox supportati da questa guida** Questi dispositivi sono conformi alla direttiva CEE 2014/30/EU relativamente ai dispositivi digitali di Classe A. Sono stati provati e sono risultati conformi alle norme EN55032/CISPR32 e EN55024/CISPR24. In un ambiente domestico, questi prodotti possono causare radiointerferenze, nel qual caso all'utente potrebbe venire richiesto di prendere le misure adeguate. Per soddisfare i requisiti CEE, il monitor e le altre periferiche vanno collegati alla scheda grafica con cavi schermati. Questi prodotti sono stati provati in un tipico sistema host conforme alla classe A. Inoltre, si dà per scontato che questi prodotti acquisiranno la conformità in qualsiasi sistema conforme alla classe A.

## **(Español) Información para usuarios europeos – Declaración de conformidad**

**Observación referente a los productos de hardware de Matrox apoyados por este manual** Estos dispositivos cumplen con la directiva de la CE 2014/30/EU para dispositivos digitales de Clase A. Dichos dispositivos han sido sometidos a prueba y se ha comprobado que cumplen con las normas EN55032/CISPR32 y EN55024/CISPR24. En entornos residenciales, estos productos pueden causar interferencias en las comunicaciones por radio; en tal caso el usuario deberá adoptar las medidas adecuadas. Para satisfacer las disposiciones de la CE, deberán utilizarse cables apantallados para conectar el monitor y demás periféricos a la tarjeta. Estos productos han sido sometidos a prueba en un típico sistema anfitrión que responde a los requisitos de la clase A. Se supone que estos productos cumplirán también con las normas en cualquier sistema que responda a los requisitos de la clase A.

---

### **KOREA**

---

#### **A 급 기기 (업무용 방송통신기자재)**

이 기기는 업무용 (A 급) 전자파적합기기로서 판 매자 또는 사용자는 이 점을 주의하시기 바라며, 가정외의 지역에서 사용하는 것을 목적으로 합니다.

---

### **EUROPE**

---

#### **(English) European user's information – Directive on Waste Electrical and Electronic Equipment (WEEE)**

Please refer to the Matrox Web site ([www.matrox.com/environment/en/weee](http://www.matrox.com/environment/en/weee)) for recycling information.



#### **(Français) Informations aux utilisateurs Européens – Règlementation des déchets d'équipements électriques et électroniques (DEEE)**

Se référer au site Web de Matrox ([www.matrox.com/environment/en/weee](http://www.matrox.com/environment/en/weee)) pour l'information concernant le recyclage.

#### **(Deutsch) Information für europäische Anwender – Europäische Regelungen zu Elektro- und Elektronikaltgeräten (WEEE)**

Bitte wenden Sie sich an der Matrox-Website ([www.matrox.com/environment/en/weee](http://www.matrox.com/environment/en/weee)) für Recycling-Informationen.

#### **(Italiano) Informazioni per gli utenti europei – Direttiva sui rifiuti di apparecchiature elettriche ed elettroniche (RAEE)**

Si prega di riferirsi al sito Web Matrox ([www.matrox.com/environment/en/weee](http://www.matrox.com/environment/en/weee)) per le informazioni di riciclaggio.

---

## Trademarks • Marques déposées • Warenzeichen • Marchi registrati • Marcas registradas

Matrox Electronic Systems Ltd. /

Matrox Graphics Inc. ....	Matrox®, DualHead®, Avio™, C-Series™, D-Series™, DualHead2Go™, Extio™, G400™, G450™, G550™, GXM™, Maevex™, Marvel™, MED2mp™, MED2mp-DVI™, MED3mp-DVI™, MED4mp™, MED5mp-DVI™, MED5mp™, Millennium™, MMS™, Multi-Monitor Series™, MultiDesk™, Mura™, MuraControl™, Mystique™, P650™, P690™, P750™, Parhelia™, Parhelia™ APVe, Parhelia-512™, Parhelia-LX™, Parhelia HR256™, PJ4OLP™, QID™, Quad Information Display™, RAD™, Quick Connect™, MaxVIEW™, Onyx™, PixelTOUCH™, PrecisionCAD™, Precision SGT™, QuadHead2Go™, QuickDesk™, RAD2mp™, RAD3mp™, RAD9mp™, RADQ2mp™, Rainbow Runner®, TheatreVUE™, TripleHead™, TripleHead2Go™, VDA™, Veos™, Xenia™
Adobe Systems Inc. ....	Acrobat®, Reader®
Advanced Micro Devices, Inc. ....	AMD®
Apple Computer, Inc. ....	App Store®, Apple®, iPad®, Mac®, Mac OS®
Belden Inc. ....	Belden®
Dolby Laboratories, Inc.....	Dolby®, Dolby Digital®
Facebook, Inc. ....	Facebook®
Google, Inc.....	YouTube®
HDMI Licensing LLC.....	HDMI®
Intel Corporation .....	Intel®
International Business Machines .....	IBM Video Streaming™
Linus Torvalds .....	Linux®
Microsoft Corporation.....	Active Directory®, Aero®, Direct3D®, DirectShow®, DirectX®, Microsoft®, MS-DOS®, PowerPoint®, Windows®, Windows NT®, Windows Server®, Windows Vista®
Panopto, Inc. ....	Panopto™
PCI-SIG.....	PCI™, PCI-X®, PCIe®, PCI Express®
Radio Corporation of America .....	RCA®
RealVNC Ltd. ....	VNC®
Restream, Inc.....	Restream™
Rovi Corporation.....	Macrovision®
SD-3C, LLC.....	SD™, SDHC™, SDXC™
Silicon Graphics, Inc. ....	OpenGL®
Silicon Image, Inc.....	PanelLink®, TMDS®
Twitch Interactive, Inc. ....	Twitch™
U.S. Environmental Protection Agency.....	ENERGY STAR®
Video Electronics Standards Association .....	DisplayPort™
VideoLAN .....	VideoLAN®, VLC®, VLC® media player
Vimeo, LLC .....	Vimeo®

Wibu-Systems ..... WIBU®  
Wowza Media Systems, LLC ..... Wowza™

Copyright © 1996-2020 VideoLAN. This logo or a modified version may be used or modified by anyone to refer to the VideoLAN project or any product developed by the VideoLAN team, but does not indicate endorsement by the project.

HTML5 Logo by World Wide Web Consortium ([W3C](http://www.w3c.org)). This HTML5 logo is licensed under this Public License (<http://www.creativecommons.org/licenses/by/3.0/legalcode>). The logo has been modified to meet the resolution and size required by this application.

• (English) Registered trademarks are registered in the United States, Canada, and/or other countries. All other nationally and internationally recognized trademarks and tradenames are hereby acknowledged. • (Français) Les marques déposées sont déposées aux États-Unis, au Canada et/ou dans d'autres pays. Toutes les autres marques et tous les autres noms déposés reconnus nationalement ou internationalement sont également reconnus par les présentes. • (Deutsch) Die eingetragenen Warenzeichen sind in den USA, Kanada und/oder anderen Ländern registriert. Alle sonstigen national und international bekannten Warenzeichen und Produktnamen werden hiermit anerkannt. • (Italiano) I marchi registrati sono registrati negli Stati Uniti, in Canada e/o in altri paesi. Tutti gli altri marchi registrati e nomi commerciali riconosciuti a livello nazionale e internazionale sono ugualmente riconosciuti qui. • (Español) Las marcas registradas están registradas en los EE.UU., Canadá u otros países. Por medio del presente se reconocen todas las demás marcas y nombres comerciales reconocidos a nivel nacional e internacional.

---

## **(English) Disclaimer**

THE INFORMATION IN THIS GUIDE IS SUBJECT TO CHANGE AT ANY TIME AND WITHOUT NOTICE.

Matrox Graphics Inc. reserves the right to make changes in specifications at any time and without notice. The information provided by this document is believed to be accurate and reliable at the time it is written. However, no responsibility is assumed by Matrox Graphics Inc. for its use, for its reproduction and/or distribution, in whole or in part; nor for any infringements of patents or other rights of third parties resulting from its use.

---

## **(Français) Responsabilité**

LES INFORMATIONS CONTENUES DANS CE MANUEL PEUVENT ÊTRE MODIFIÉES EN TOUT TEMPS ET CE SANS PRÉAVIS.

Les Graphiques Matrox Inc. se réserve le droit de modifier les spécifications en tout temps et ce sans préavis quelconque. Les informations contenues dans ce manuel sont reconnues comme étant précises et fiables à la date de rédaction. Cependant, Matrox Graphics Inc. n'assume aucune responsabilité concernant leur utilisation, leur reproduction et/ou distribution, en tout ou en partie, ni leur contrefaçon de brevets ou de tout autre droit appartenant à des tiers résultant de leur utilisation. Aucune licence n'est accordée sur aucun brevet ou droit d'exploiter un brevet de Matrox Graphics Inc.

---

## **(Deutsch) Haftungsablehnungserklärung**

DIE IN DIESEM HANDBUCH ENTHALTENEN ANGABEN UND DATEN KÖNNEN OHNE VORHERIGE ANKÜNDIGUNG GEÄNDERT WERDEN.

Die Matrox Graphics Inc. behält sich das Recht vor, jederzeit und ohne Ankündigung technische Daten zu ändern. Zum Zeitpunkt der Erstellung dieses Handbuchs sind die Inhalte korrekt und verlässlich. Weiterhin übernimmt Matrox Graphics Inc. keinerlei Verantwortung für die Benutzung dieses Handbuchs, die Vervielfältigung und/oder Verteilung im Ganzen oder zum Teil; weder für Verstöße gegen Patentrechte noch für andere Rechte Dritter, die aus seinem Gebrauch resultieren mögen. Es werden keinerlei Lizenzrechte gewährt für sämtliche Patente oder Patentrechte der Matrox Graphics Inc.

---

## **(Italiano) Discrezionalità**

LE INFORMAZIONI CONTENUTE NEL PRESENTE DOCUMENTO SONO SOGGETTE A MODIFICHE IN QUALUNQUE MOMENTO E SENZA PRAEAVVISO.

Matrox Graphics Inc. si riserva il diritto di apportare variazioni di qualunque tipo alle specifiche tecniche in qualunque momento e senza alcun preavviso. Le informazioni contenute in questa documentazione sono ritenute corrette e attendibili al momento della pubblicazione. In ogni caso, non è imputabile a Matrox Graphics Inc. nessuna responsabilità per il loro utilizzo, per la loro distribuzione e/o riproduzione completa o in parte, come nessuna violazione a brevetti o diritti di altri produttori derivante dal loro utilizzo.

---

## **(Español) Renuncia**

LA INFORMACION QUE CONTIENE EL PRESENTE MANUAL ESTA SUJETA A CAMBIOS SIN PREVIO AVISO EN CUALQUIER MOMENTO.

Matrox Graphics Inc. se reserva el derecho de realizar modificaciones en cualquier momento y sin previo aviso. La información facilitada en este documento se considera que es exacta y fiable hasta la fecha de publicación. Sin embargo, Matrox Graphics Inc. no asume ninguna responsabilidad por su uso, por su reproducción y/o distribución parcial o total; ni por cualquier infracción de patentes u otros derechos de terceras partes derivados de su uso. No se concede ninguna licencia bajo cualesquiera patentes o derechos de patentes de Matrox Graphics Inc.

**Matrox Graphics Inc.**

1055 Saint Regis Boulevard  
Dorval, Quebec, Canada H9P 2T4  
(514) 822-6000

[graphics@matrox.com](mailto:graphics@matrox.com)  
[www.matrox.com/graphics](http://www.matrox.com/graphics)

**matrox**<sup>®</sup>  
Graphics for Professionals