

PURE *Mounts*®

INSTALLATION MANUAL

PM-TVS-01

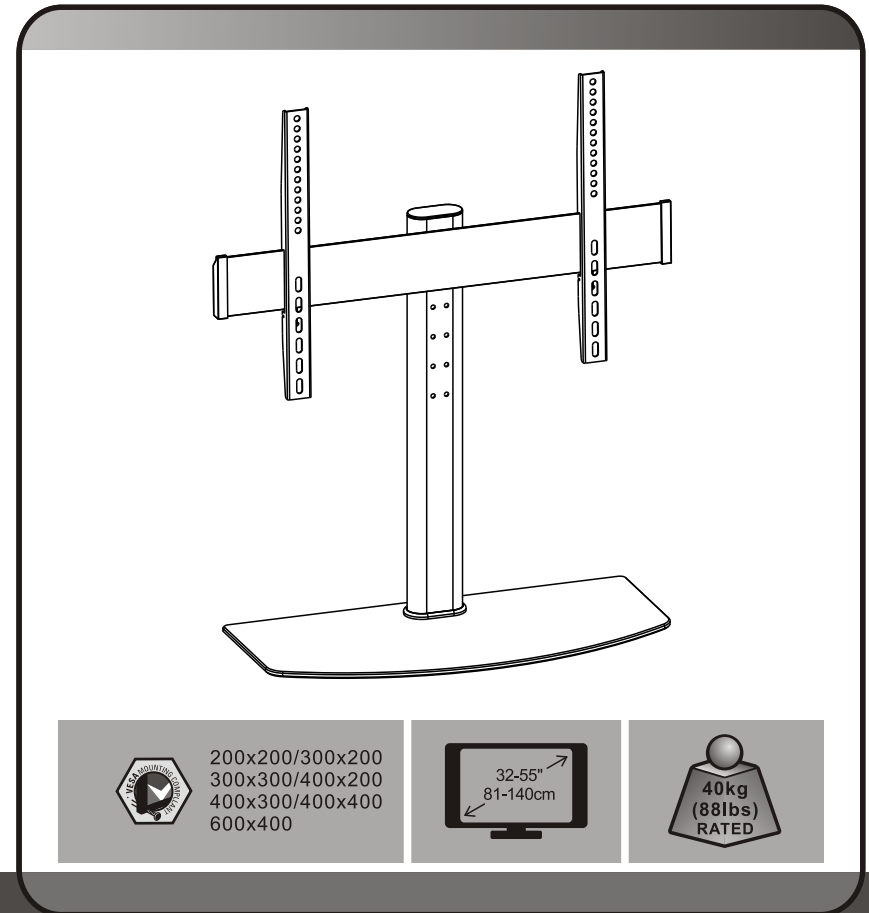

200x200/300x200  
300x300/400x200  
400x300/400x400  
600x400

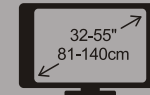









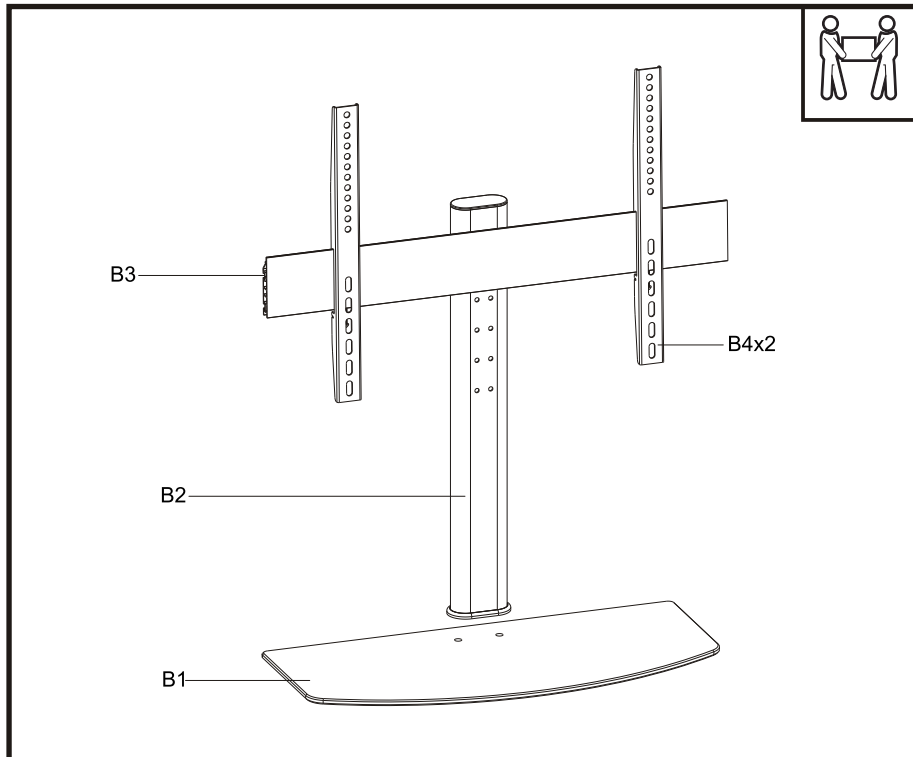





# TV STANDS

## ASSEMBLY INSTRUCTIONS

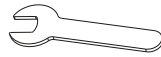
PureLink GmbH  
Von-Liebig-Str. 10 | 48432 Rheine | Germany  
Phone: +49 (0) 5971 800 299 0

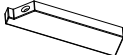
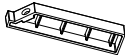
PureLink GmbH hereby declares that this product complies with Directive 1907/2006/EU and 2011/65/EU.

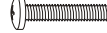
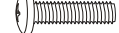
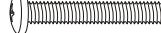

A1x4 	A2x6 	A3x6 	A4x2 	A5x4 
A6x2 	A7x4 	A8x1 	A9x1 	A10x2 
A11x1 	A12x1 	A13x1 		
M5x14 (x4) M-A 	M6x14 (x4) M-B 	M6x30 (x4) M-C 	M8x30 (x4) M-D 	M8x50 (x4) M-E 
(x4) M-F 	(x8) M-G 	(x8) M-H 