

# PureLink

**VIDEO SOUNDBAR** | All-In-One Conferencing Solution



## QUICK START GUIDE

 **Vuelogic**

VL-VB200





## INTRODUCTION

This product is an all-in-one meeting videobar with ultra-wide angle 4K camera, microphone and speaker. It is ideal for applications in huddle rooms, small meeting rooms, private offices and home offices.

## FEATURES

- Wide angle 4K video camera with 120° FOV.
- 4 x MEMS digital microphone arrays with a range of 3 ~ 5 meters and an angle of 180°.
- 2 x 3W Stereo full range speakers with passive radiator bass enhancement.
- Includes AEC (Acoustic Echo Cancellation), AGC (Automatic Gain Control), ANS (Automatic Noise Suppression) and full duplex mode communication to make all participants feel like they are in the same room.
- Auto Framing / Speaker Tracking / Presenter Tracking based on AI technology makes meetings more intimate and friendly.
- Plug and play with excellent compatibility for OS and UC applications, such as Zoom, WebEx, Tencent meeting, Teams, etc.
- Windows and MAC OS App provided for easy control.

## PACKAGE CONTENTS

1x Video Bar  
1x DC 12V Power Adapter

1x Magnetic Lens Cap  
1x Wall-mounted Bracket  
6x Expansion Screws  
6x Mounting Screws

## SPECIFICATIONS

<b>AUDIO AND VIDEO</b>	
Input/Output	1 x USB-C
Video Resolutions (Max)	3840x2160 @30Hz
Output Video Encoding	MJPEG/YUY2/H.264/H.265   UVC 1.1

<b>CAMERA AND SENSOR</b>	
Lens	Fixed focus
Sensor	1/2.8", CMOS, Effective Pixel: 8.0M
White Balance	Auto
Backlight Compensation	Auto
Digital Noise Reduction	2D, 3D Digital noise reduction supported
Viewing Angle	FOV 120°
ePTZ	Supported   5 x Digital Zoom
HDR	Supported
Tracking Mode	Auto Framing / Speaker Tracking / Presenter Tracking

<b>SPEAKERPHONE</b>	
Microphone	4 x Linear microphone arrays with echo cancellation Pick-up Range: 5m
Speaker	2 x 3 W

<b>COMMUNICATION AND CONTROL</b>	
USB-C	USB Type-C female with locking
Control Method	Windows or MAC OS App

<b>GENERAL</b>	
Operating Temperature	0°C ~ 40°C, 10% to 90%, non-condensing
Storage Temperature	-20°C ~ 60°C, 10% to 90%, non- condensing
MTBF	>30000h
Power Supply	DC12V 2A
Power Consumption (Max)	6W
Dimension (Width x Height x Depth)	460 mm x 97.43 mm x 61 mm (with Bracket)
Net Weight	0.81 kg (with Bracket)
Gross Weight	2.06 kg



## PANEL DESCRIPTION

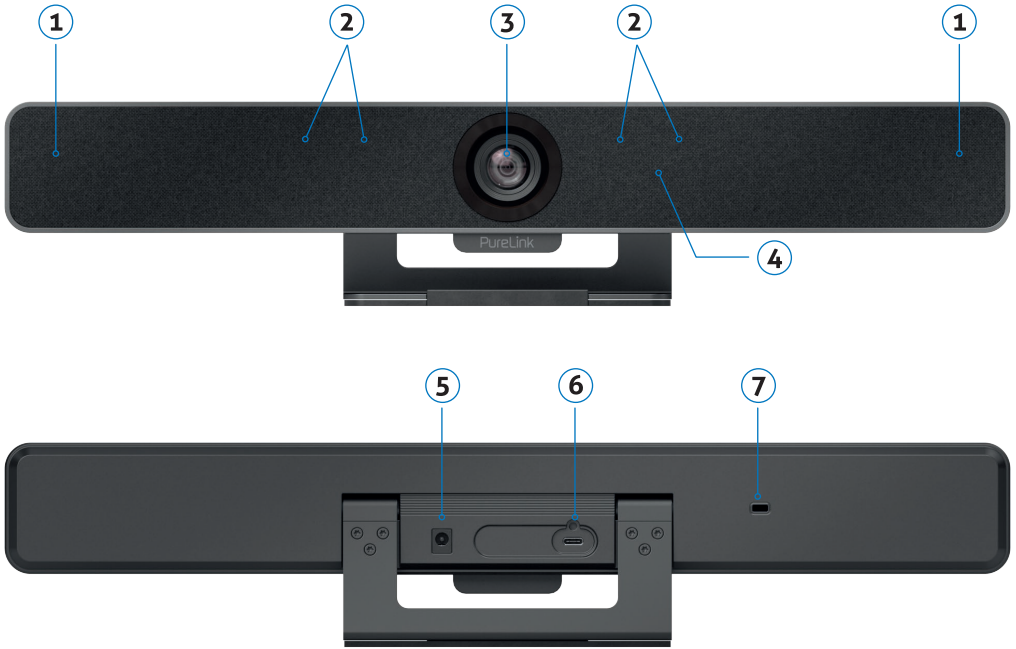

ID	NAME	DESCRIPTION
1	Speaker	Outputs audio signal of the input source.
2	Microphone	4 x Linear mic arrays for picking up sound.
3	Lens	Camera lens
4	Status LED	<ul style="list-style-type: none"><li>• Constant blue: The device is powered on. The device is in standby state.</li><li>• Constant white: The device is working properly.</li><li>• Blinking white quickly: The device is being upgraded.</li><li>• Constant red: The device's microphone is muted.</li></ul>
5	Power	12V 2A DC power input. Connect to the power adapter provided.
6	USB-C	USB Type C port. Connect to the PC for transmitting audio and 4K camera video signal using the USB-C cable provided.
7		Kensington security slot

## INSTALLATION

**Note:** Before installation, please ensure the device is disconnected from the power source.

### To install the device on a monitor:

Place the device on the top of a monitor, then adjust the bracket's angle so that the device stands firmly on the monitor.

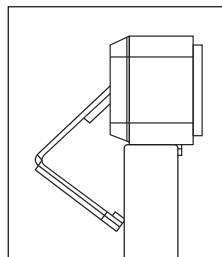

### To install the device on a tripod:

1. Screw the tripod's clip into the M12 thread hole at the device's bottom.
2. Secure the device along with the clip on the tripod, adjust to a position and height you desire.

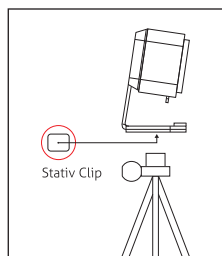

### To install the device on the wall:

1. Drill holes in the wall you desire, then insert the expansion screws provided into the holes.
2. Secure the wall-mounted bracket provided on the wall using the screws provided.
3. Secure the device on the wall-mounted bracket.

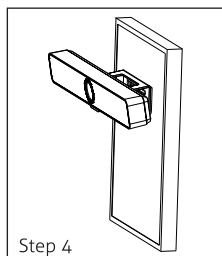
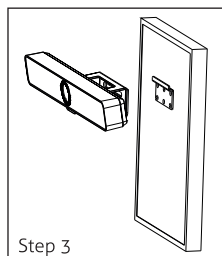
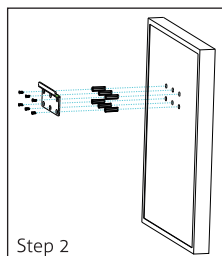
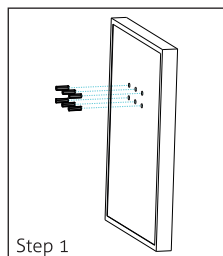
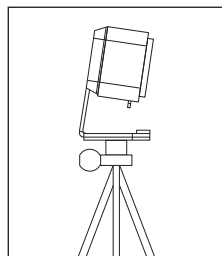



## APPLICATION

### Application 1 - Huddle/small room (for 2~7 people)

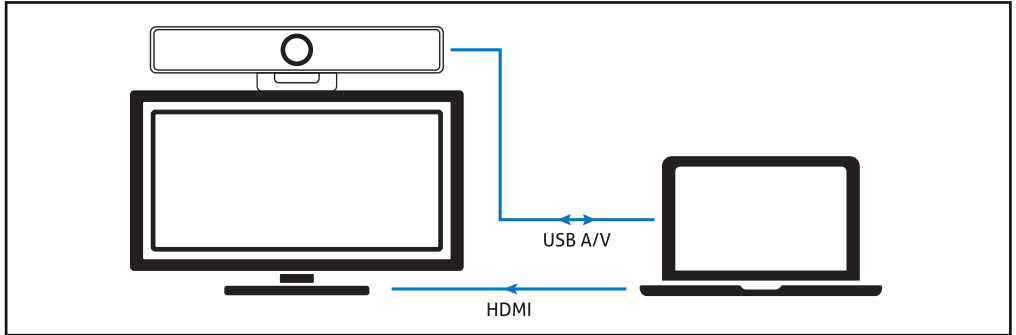

### Application 2 – Private office/Home office

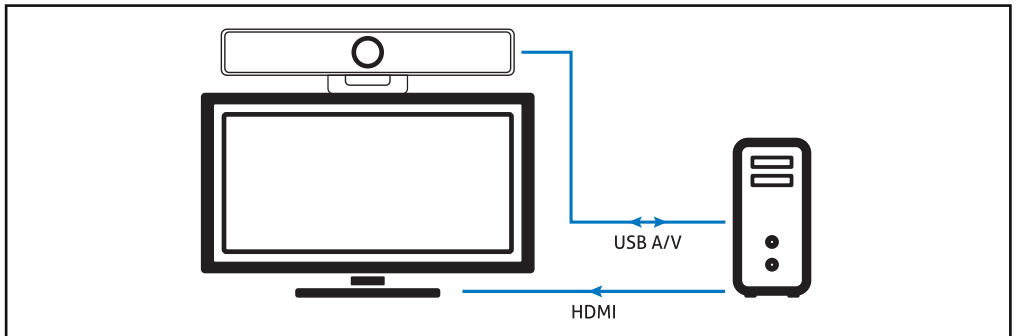

Note: After the device is connected to a computer, it can be detected by the system and specific applications in the name of the following:

- Model: VB200
- Camera: VB200
- Speaker: VB200
- Microphone: VB200

## Controls-Videos

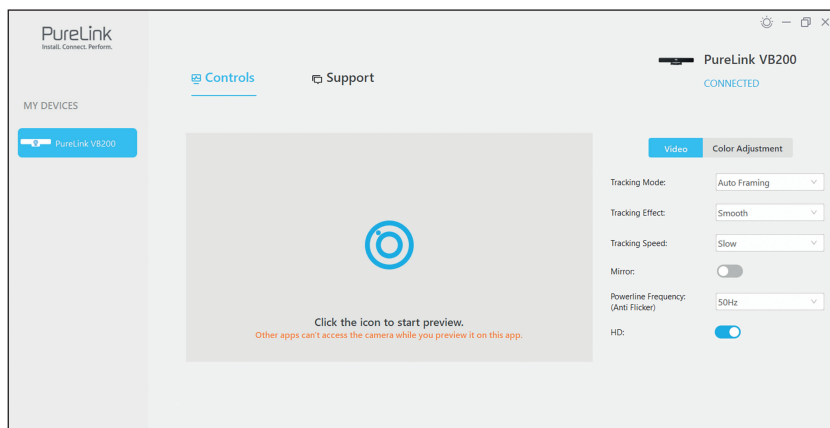

ELEMENTS	DESCRIPTION/OPTIONS
Tracking Mode	<ul style="list-style-type: none"> <li>• Auto Framing (default): Camera tracks group participants automatically.</li> <li>• Speaker Tracking: Camera tracks speakers automatically.</li> <li>• Presenter Tracking: Camera tracks the first recognized presenter automatically.</li> <li>• Off</li> </ul>
Tracking Effect	<p>Tracking effect is available when Auto Framing is enabled.</p> <ul style="list-style-type: none"> <li>• Smooth (default): The tracking image moves smoothly in the frame.</li> <li>• Immediate: The tracking image switches from one to another immediately in the frame.</li> </ul>
Tracking Speed	<p>Tracking speed is available when Auto Framing is enabled.</p> <ul style="list-style-type: none"> <li>• Slow (default)/Normal/Fast</li> </ul>
Mirror	<ul style="list-style-type: none"> <li>• Mirror image function</li> <li>• On: Image flipped horizontally.</li> <li>• Off (default setting): Image not flipped horizontally.</li> </ul>
Powerline Frequency (Anti Flicker)	<p>Change the frequency to prevent flicker in the video.</p> <ul style="list-style-type: none"> <li>• 50Hz (default) /60Hz</li> </ul>
HD	<ul style="list-style-type: none"> <li>• On (default): Turn on for better image quality.</li> <li>• Off: Turn off for better compatibility.</li> </ul>
	<p>Click this icon to enable camera preview.</p> <p>Note: Other Apps cannot use the camera until camera preview is disabled.</p>



## Controls-Color Adjustment

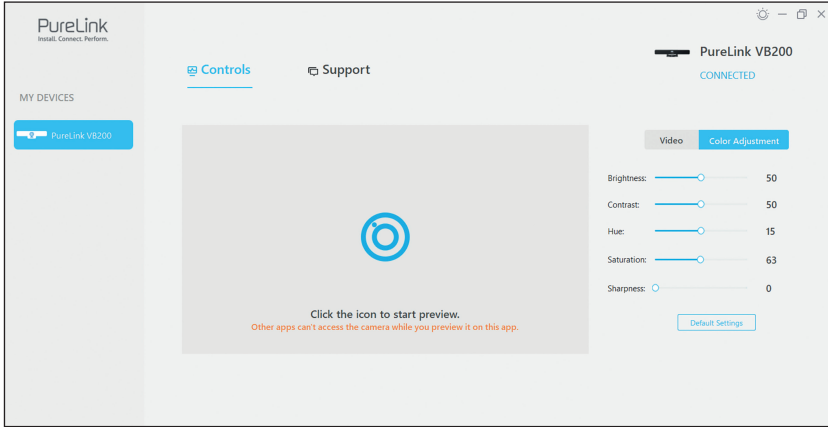

ELEMENTS	DESCRIPTION/OPTIONS
Brightness	Adjust the brightness of the camera manually.
Contrast	Adjust the contrast of the camera manually.
Hue	Adjust the hue of the camera manually.
Saturation	Adjust the saturation of the camera manually.
Sharpness	Adjust the sharpness of the camera manually.
Default Settings	Restores all color parameters to their default values.



## Support

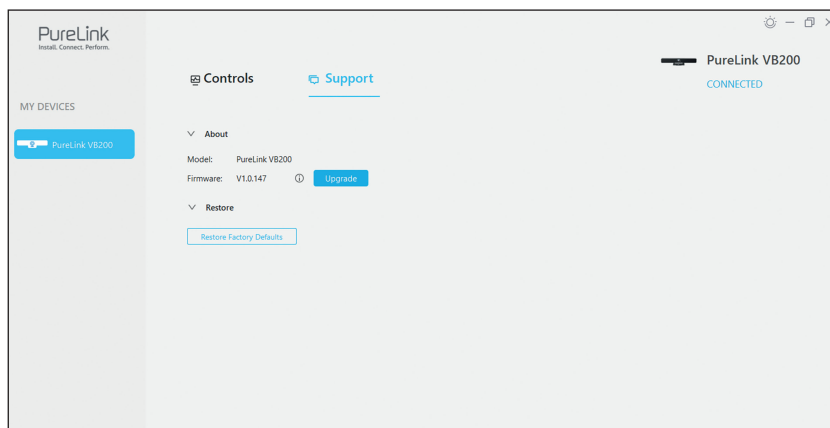

ELEMENTS	DESCRIPTION/OPTIONS
About	Displays device model and firmware information.
About-Upgrade	Select the firmware file and upload it for upgrade.
Restore	Restore Factory Defaults

For further support or questions please contact us under <https://www.purelink.de/en/anfrage-formular-purelink.de> or scan the QR- code below





## CE CONFORMITY



PureLink GmbH hereby declares that this product is in compliance with the essential requirements and other relevant provisions of the **EMC Directive 2014/30/EU** and the **RoHS Directive 2011/65/EU amended by 2015/863/EU**.



PureLink GmbH hereby declares that this product is in compliance with the essential requirements of the **Electromagnetic Compatibility Regulations 2016** and all other applicable UK regulations.

The EU Declaration of Conformity is available here:

[www.purelink.de](http://www.purelink.de)

## DISPOSAL OF DEVICE



WEEE-Reg.-Nr. DE 93847290

According to the European WEEE Directive, electrical and electronic equipment may not be disposed of with household waste. As a consumer, you are obliged to return electrical and electronic equipment free of charge at the end of its service life to the public collection points set up for this purpose or to the point of sale. Details on this are regulated by the respective national law. The symbol on the product, the instructions for use or the packaging refers to these regulations. Recycling old appliances in this way is an important contribution to the protection of our environment.

## DISCLAIMER OF LIABILITY

PureLink GmbH will not be held liable, nor provide any warranty for damage resulting from improper installation, assembly and use of the product, or failure to observe the operating instructions and/or safety instructions.

## TRADEMARK

Product model and logo are trademarks. All other trademarks mentioned in this manual are acknowledged as the property of the trademark owners. No part of this publication may be copied or reproduced without prior written permission of their respective owners.



---

## PureLink GmbH

Von-Liebig-Str. 10  
D - 48432 Rheine  
Germany  
[www.purelink.de](http://www.purelink.de)  
WEEE-Reg.-No. DE 93 847 290

## PureLink UK LTD.

Carpenter Court, 1 Maple Road  
Bramhall, Stockport  
Cheshire SK7 2DH  
United Kingdom

V1 | 2023-07