

DIRECT STREAMING AV MIXER

VR-120HD

Version 2.0 and later

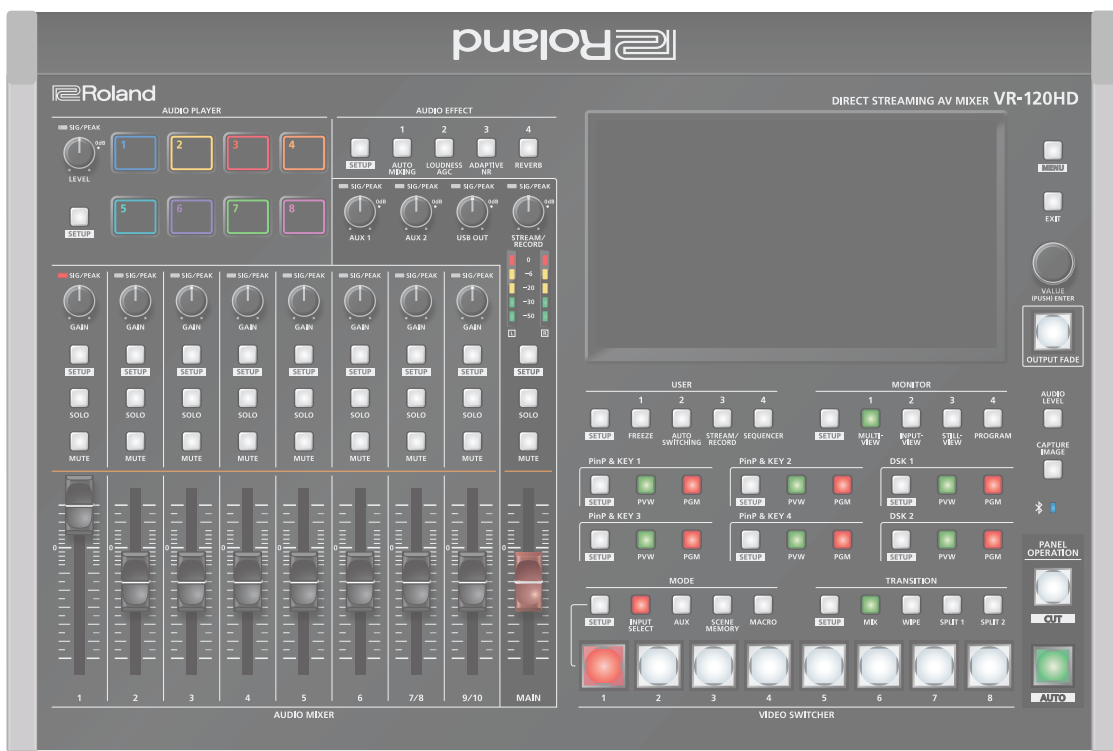

- The **Bluetooth**® word mark and logos are registered trademarks owned by Bluetooth SIG, Inc. and any use of such marks by Roland is under license.
- QR Code is a registered trademark of DENSO WAVE INCORPORATED in Japan and in other countries.
- Roland is an either registered trademark or trademark of Roland Corporation in the United States and/or other countries.
- Company names and product names appearing in this document are registered trademarks or trademarks of their respective owners.

Contents

Panel Descriptions	4	◇ Inputting SRT Video	33
◇ Top Panel	4	Network Requirements	33
◇ Front Panel	6	Assigning the SRT Input Video Channel to the VIDEO SWITCHER [1]–[8] Buttons	33
◇ Rear Panel	7	Connecting an SRT-compatible Device to Input SRT Video	33
◇ Connecting Bluetooth® Devices	8	◇ Fading-In/Out the Final Output Video	35
Registering a Bluetooth Audio Device (Pairing)	8	◇ Freezing the Input Video (Freeze)	36
Connecting an Already-Paired Bluetooth Device	8	Setting the Operation Mode	36
◇ Connecting a Footswitch	9	Freezing the Input Video	36
◇ Turning the Power On/Off	10	Video Composition Operations	37
◇ Operating the Menu	10	◇ Compositing Video with Picture-in-Picture (PinP)	37
◇ Operating the Setup Screen	11	Making Detailed Settings for the Inset Screen	38
◇ Switching the Monitor View	12	◇ Compositing Video with Downstream Keyer (DSK)	40
◇ About SD Card	13	About DSK Mode	40
Inserting the SD Card	13	Compositing a Caption or Image (Luminance Key)	41
Formatting an SD Card	13	Compositing a Subject and Background (Chroma Key)	42
Removing an SD Card	13	Compositing a Still Image with Alpha Channel	44
◇ About USB Flash Drive	13	Using an External Key	45
Formatting a USB Flash Drive	13	Compositing Content from Graphics Presenter (Roland Fill+Key mode)	46
Removing a USB Flash Drive	13	Swapping and Copying Settings	47
Video Input/Output Settings	14	Audio Operations	48
◇ Setting the Video Input/Output Format	14	◇ Assigning Audio Sources to Audio Channels	48
Setting the System Format	14	◇ Adjusting the Input Gain (Sensitivity)	48
Setting the Input Format for the HDMI IN 1–6 Connectors	14	◇ Adjusting the Volume Balance	49
◇ Assigning Video Sources	15	Adjusting the Volume Balance from the Mixer Screen	50
◇ Adjusting Output Video	15	◇ Applying Effects to Input Audio	51
◇ Adjusting Input Video	16	Using an Effect Preset	52
◇ Assigning Video Buses to Output Connectors	17	Reducing Acoustic Feedback (Anti-Feedback)	53
◇ Selecting the Video Sent to the AUX 1–3 Bus	18	Changing the Character of a Voice (Voice Changer)	53
◇ Inputting Copy-Protected (HDCP) Video	18	Applying Reverb	54
◇ Specifying a Reference Clock	19	◇ Applying Effects to Output Audio	55
Video Operations	20	◇ Interlinking Audio Output to Video Switching (Audio Follow)	55
◇ Switching the Video	20	Adding an Object for Audio Follow	55
Setting the Operation Mode	20	◇ Removing Noise from the Audio (Adaptive Noise Reduction / Low Frequency Cut)	56
Switching in the Dissolve Mode	20	◇ Automatically Setting a Comfortable Volume (Auto Mastering Effect)	57
Switching in the PGM/PST Mode	21	Loudness Auto Gain Control (Loudness AGC)	57
Changing the Mix Pattern	21	◇ Controlling the Volume Automatically (Auto Mixing)	58
Changing the Wipe Pattern	21	◇ Silencing Only Specific Audio (Mute)	59
◇ Splitting the Video	22	Muting Input Audio	59
Configuring the Screen Layout	22	Muting the Output Audio	59
Displaying the Split	22	◇ Checking a Specific Audio Input (Solo)	60
◇ Switching the Video Automatically (Auto Switching)	23	Soloing the Input Audio	60
About the Operation Mode	23	Soloing the Output Audio	60
Turning the Auto Switching Function On/Off	23	◇ Playing Back Audio Files (Audio Player)	61
Setting the Operation Mode	23	Importing an Audio File	61
◇ Loading a Still Image	27	Playing Back Audio Clips	61
Loading a Still Image from a Storage	27	Setting an Audio Clip	62
Capturing a Still Image from Input/Output Video	28	Mixer Settings for the Audio Player	63
◇ Outputting a Loaded Still Image	28	◇ Outputting AUX-bus Audio	64
Assigning a Still Image to the VIDEO SWITCHER Buttons	28	Assigning the AUX Bus	64
Inserting a Still Image in the Final Output	28	Sending Audio to the AUX Bus	64
◇ Deleting a Still Image	29	◇ Adding Input Audio to an HDMI or SDI Video for Output	65
◇ Saving a Still Image to a SD Card or USB Flash Drive	30		
◇ Importing a Video	31		
◇ Outputting a Loaded Video	32		
Playing Back a Video (with the Video Player)	32		
Assigning Videos to the VIDEO SWITCHER Buttons	32		
Inserting a Video in the Final Output	32		

Live Streaming 66

- ◇ **Outputting Video/Audio to a Computer for Streaming** 66
 - Outputting Video and Audio to the Computer 66
 - Using the Loopback Function 66
 - Streaming Video from a Computer 66
 - Capturing Video on the Computer 66
- ◇ **Streaming/Capturing Video Directly** 67
 - Network Requirements 67
 - Points to Be Aware of When Livestreaming 67
 - Starting/Stopping the Livestream, Audio or Video Recording ... 67
 - Turning Livestreaming, Audio and Video Recording ON/OFF 67
 - Livestreaming via YouTube Live 68
 - Livestreaming via Facebook Live 69
 - Livestreaming via Twitch 70
 - Streaming with Custom Settings 71
 - Tethering 72
 - Avoiding Sporadic Issues When Livestreaming (Safety Delay) ... 73
- ◇ **Outputting the SRT Video** 75
 - Network Requirements 75
 - Connecting an SRT-compatible Device to Output SRT Video 75

Other Functions 78

- ◇ **Saving/Recalling Settings (Scene Memory)** 78
 - Saving to a Scene Memory 78
 - Recalling a Scene Memory 79
 - Initializing a Scene Memory 79
 - Renaming a Scene Memory 79
 - Changing the Thumbnail Position 80
 - Saving Scene Memories to an SD Card or USB Flash Drive 80
- ◇ **Recording Multiple Operations to Automatically Execute (Macros)** 82
 - Recording a Macro 82
 - Executing a Macro 84
 - Copying Macro Settings 85
 - Swapping the Macro Settings 85
 - Initializing a Macro 86
 - Renaming a Macro 86
 - Saving/Loading the Macro Settings 87
 - Initializing All Macros 88
- ◇ **Combining Scene Memories and Macros for Operations (Sequencer)** 89
 - Recording to the Sequencer 89
 - Running the Sequencer 91
 - Making the Sequencer Run Automatically (Auto Sequence) 92
 - Saving/Loading the Sequencer Settings 93
 - Initializing the Sequencer 94
- ◇ **Backing Up and Restoring the Unit's Settings** 95
 - Backing Up 95
 - Restoring 96
- ◇ **Assigning Functions to the USER Buttons** 97
- ◇ **Controlling an External Recorder's Video Record Start/Stop from the VR-120HD** 97
- ◇ **Remotely Controlling a PTZ Camera** 98
 - Network Settings on the Camera 98
 - Registering Camera Settings in a Preset 98
 - Recalling a Preset 99
- ◇ **Using an Expression Pedal** 100
 - Adjusting the Pedal (Pedal Calibration) 100
 - Assigning a Function to the Pedal 100
- ◇ **Using a Footswitch** 101

- ◇ **Control Using the USB Numeric Keypad** 101
- ◇ **Control Using the TALLY/GPIO Connector** 102
 - Specification of the TALLY/GPIO Connector 102
 - Inputting a Control Signal 102
 - Outputting a Tally Signal 103
 - Outputting a Control Signal 103
- ◇ **Using Smart Tally** 104
 - Connecting via a Wireless LAN Router 104
 - Starting Smart Tally 104
- ◇ **Preventing Unintended Operation (Panel Lock)** 105
- ◇ **Remotely Controlling the VR-120HD** 106
- ◇ **Returning to the Factory Settings (Factory Reset)** 107

Menu List 108

- 1: Video Assign** 108
- 2: Video Input** 110
- 3: Video Output** 111
- 4: Transition** 112
- 5: PinP & Key** 113
- 6: DSK** 115
- 7: Audio Fader/Knob Assign** 116
- 8: Audio Input** 117
- 9: Audio Output** 135
- 10: Audio Follow** 144
- 11: Audio Auto Mixing** 144
- 12: Audio Player** 145
- 13: Stream/Record** 146
- 14: Scene Memory** 148
- 15: Macro** 149
- 16: Sequencer** 149
- 17: Still Image** 150
- 18: Video Player/SRT In** 151
- 19: Roland Fill+Key** 152
- 20: Freeze** 152
- 21: Auto Switching** 152
- 22: Ctl/Exp** 154
- 23: RS-232/Tally/GPO/GPI/Keypad** 156
- 24: Network** 158
- 25: Camera Control** 159
- 26: SD Card/USB Memory** 159
- 27: System** 160

Appendix 166

- ◇ **About Rack Mounting** 166
 - Attaching the Rack-Mount Angles 166
 - Important Notes on Rack Mounting 166
- ◇ **Main Specifications** 167
- ◇ **Dimensions** 171
- ◇ **Video Block Diagram** 172
- ◇ **Audio Block Diagram** 173

Panel Descriptions

Top Panel

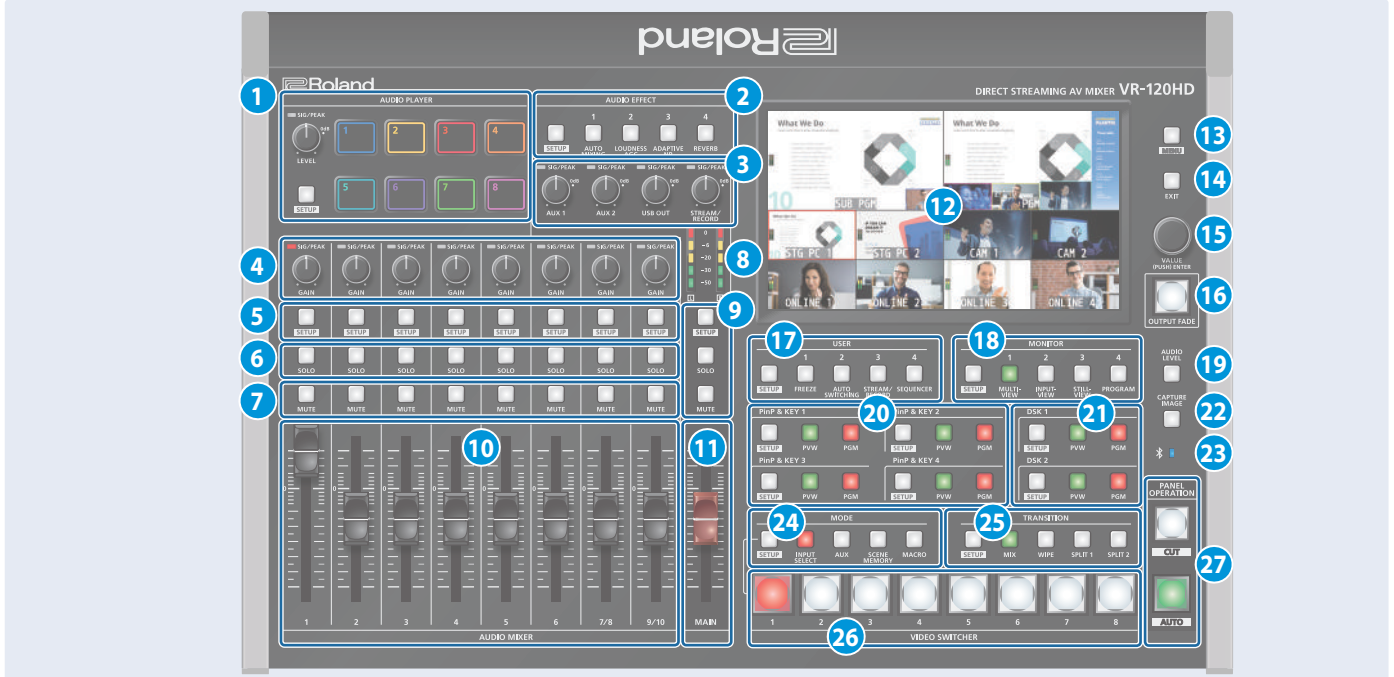

1 AUDIO PLAYER

This section lets you assign sound sources such as background music, sound effects and so on to the pads and then play them back.

* You can use an audio file (WAV format) stored on a USB flash drive or an SD card as the source.

[LEVEL] knob

Adjusts the playback volume of the sound source.

SIG/PEAK indicator

These indicators light up when audio output is detected.

Lit red	Excessive volume (0 dB and above)
Lit yellow	Appropriate volume (-20 to -1 dB)
Lit green	Insufficient volume (-50 to -21 dB)

[SETUP] button

Shows the setup screen in the display.

Pads [1]–[8]

Press a pad to play back the assigned sound source.

2 AUDIO EFFECT

[1]–[4] buttons

Press to turn the audio effects on/off. You can also assign different functions to each button.

[SETUP] button

Shows the setup screen in the display.

3 [AUX 1], [AUX 2] knobs

Adjusts the volume of the AUX bus output.

[USB OUT] knob

Adjusts the volume of the USB output.

[STREAM/RECORD] knob

Adjusts the volume of streaming/recording.

SIG/PEAK indicators

These indicators light up when audio output is detected.

Lit red	Excessive volume (0 dB and above)
Lit yellow	Appropriate volume (-20 to -1 dB)
Lit green	Insufficient volume (-50 to -21 dB)

4 [GAIN] knobs

Adjust the gain (sensitivity) of the audio that is being input from the AUDIO IN 1–9/10 jacks.

SIG/PEAK indicators

These indicators light up when audio input is detected.

Lit red	Excessive volume (0 dB and above)
Lit yellow	Appropriate volume (-20 to -1 dB)
Lit green	Insufficient volume (-50 to -21 dB)

5 [SETUP] buttons

Shows the setup screen in the display.

6 [SOLO] buttons

Press these buttons to allow only the audio of the selected input channels to be output. When this is turned on (the button lights up) for a channel, you can monitor the pre-fader audio for that channel through headphones.

7 [MUTE] buttons

Press these buttons to mute (silence) the audio of the selected input channels.

8 Level meters

Shows the main output level.

9 [SETUP] button, [SOLO] button, [MUTE] button

These buttons are for the main output.

10 [1]–[9/10] faders

These adjust the input volume for each channel.

11 [MAIN] fader

Adjusts the output volume.

12 Display (Touch Panel)

Shows the status of the input/output video and of streaming/recording, as well as the parameters and menus.

13 [MENU] button

Switches the menu screen between visible and hidden.

14 [EXIT] button

Exits a menu level or cancels an operation.

15 [VALUE] knob

Turn	Selects the menu parameters and edits their values.
Press	Confirms the menu item you selected or the value that you edited.

16 [OUTPUT FADE] button

The final output video and audio fade in/out.

Lit	Fade-out completed
Blink	Fading-in/out
Unlit	Normal output

17 USER

[1]–[4] buttons

These buttons execute pre-assigned functions. With the factory settings, the buttons are assigned as follows.

Button	Explanation
USER [1]	FREEZE Turns the freeze function (freeze the input video) on/off.
USER [2]	AUTO SWITCHING Turns the auto switching function (used to automatically switch between videos) on/off.
USER [3]	STREAM/RECORD Shows the STREAM/RECORD setup screen in the display.
USER [4]	SEQUENCER Turns the sequencer function on/off.

[SETUP] button

Shows the setup screen in the display.

18 MONITOR

[1]–[4] buttons

Switches between video signals to monitor on the built-in display (monitor).

button	Explanation
MONITOR [1]	MULTI-VIEW The final output video, preview output video and the videos allocated to the VIDEO SWITCHER [1]–[8] buttons are shown in sections of the display.
MONITOR [2]	INPUT-VIEW The input video from the HDMI IN and SDI IN connectors and other sources are shown as 16 separate sections on the screen.

button	Explanation
MONITOR [3]	STILL-VIEW Shows the loaded still images in 16 separate sections on the screen.
MONITOR [4]	PROGRAM Shows the final output video.

* The settings described above are the factory defaults. You can also assign different functions to each button.

[SETUP] button

Shows the setup screen in the display.

19 [AUDIO LEVEL] button

Shows the audio level screen in the display.

20 PinP & KEY 1–4

This uses PinP and KEY 1–4 layers to composite video using PinP, or picture-in-picture.

[SETUP] buttons

Shows the setup screen in the display.

[PVW] buttons

Turns the inset screen preview output on/off.

[PGM] buttons

Turns PinP composition on/off.

21 DSK 1, 2

This uses DSK layer 1, 2 to composite video using a downstream keyer.

[SETUP] buttons

Shows the setup screen in the display.

[PVW] buttons

Turns the preview output of the DSK compositing result on/off.

[PGM] buttons

Turns DSK composition on/off.

22 [CAPTURE IMAGE] button

Turns the still image capture mode on/off.

23  (Bluetooth®) indicator

Shows the Bluetooth connection status.

Lit	Connected
Unlit	Bluetooth off
Blinking rapidly	Pairing is in progress
Blinking	Waiting for connection

You can input audio from an audio device that uses Bluetooth, or use dedicated software on your computer or iPad to remotely control the VR-120HD.

24 MODE

The functions of the VIDEO SWITCHER [1]–[8] buttons change according to the mode you select when pressing the buttons.

[SETUP] button

Shows the setup screen in the display.

[INPUT SELECT] button

Use the VIDEO SWITCHER [1]–[8] buttons to select the video source to send to the PGM bus or the PVW bus.

[AUX] button

Use the VIDEO SWITCHER [1]–[8] buttons to select the video signal to send to the AUX bus.

[SCENE MEMORY] button

Use the VIDEO SWITCHER [1]–[8] buttons to recall the scene memories (which contains the registered settings for video, audio and so on). Long-press the VIDEO SWITCHER [1]–[8] buttons to register the current settings in a scene memory.

[MACRO] button

This switches the function of the VIDEO SWITCHER [1]–[8] buttons to execute macros (a series of recorded operations).

25 TRANSITION

Selects the video transition effects.

[SETUP] button

Shows the setup screen in the display.

[MIX] button

The two videos are mixed as the transition occurs.

[WIPE] button

The next video moves across to replace the original video.

[SPLIT 1] button, [SPLIT 2] button

Here's how to composite two videos in dividing the screen into left/right or upper/lower.

26 VIDEO SWITCHER [1]–[8] buttons

The buttons change functions depending on the mode that's selected.

27 PANEL OPERATION

[CUT] button, [AUTO] button

These buttons determine what happens when switching between videos or else they switch between videos, depending on the operation mode.

There are two operation modes for switching between videos: "Dissolve" and "PGM/PST".

Operation mode	Explanation						
Dissolve (factory setting)	This mode selects the video to output and immediately outputs it to the PGM bus. Press the [CUT] or [AUTO] button to select what happens when you switch between videos (the buttons light up green when pressed).						
	<table border="1"> <thead> <tr> <th>Button to operate</th> <th>Action taken when pressed</th> </tr> </thead> <tbody> <tr> <td rowspan="2">VIDEO SWITCHER [1]–[8] buttons</td> <td>When [CUT] button is lit up green The video switches instantly.</td> </tr> <tr> <td>When [AUTO] button is lit up green A switch (transition) effect is applied, and the video switches automatically.</td> </tr> </tbody> </table> <p>* During the transition effect, the selected VIDEO SWITCHER button blinks red, and then remains lit up red when the transition effect finishes.</p>	Button to operate	Action taken when pressed	VIDEO SWITCHER [1]–[8] buttons	When [CUT] button is lit up green The video switches instantly.	When [AUTO] button is lit up green A switch (transition) effect is applied, and the video switches automatically.	
Button to operate	Action taken when pressed						
VIDEO SWITCHER [1]–[8] buttons	When [CUT] button is lit up green The video switches instantly.						
	When [AUTO] button is lit up green A switch (transition) effect is applied, and the video switches automatically.						
PGM/PST	In this mode, the PST video is displayed in the PVW bus, and you can check the video before outputting it to the PGM bus. Press the VIDEO SWITCHER [1]–[8] buttons to select a PST video (the buttons light up green). The content is shown in the PVW bus.						
	<table border="1"> <thead> <tr> <th>Button to operate</th> <th>Action taken when pressed</th> </tr> </thead> <tbody> <tr> <td>[CUT] button</td> <td>The video switches instantly.</td> </tr> <tr> <td>[AUTO] button</td> <td>A switch (transition) effect is applied, and the video switches automatically.</td> </tr> </tbody> </table> <p>* During the transition effect, the [AUTO] button blinks red, and then goes dark when the transition effect finishes.</p>	Button to operate	Action taken when pressed	[CUT] button	The video switches instantly.	[AUTO] button	A switch (transition) effect is applied, and the video switches automatically.
Button to operate	Action taken when pressed						
[CUT] button	The video switches instantly.						
[AUTO] button	A switch (transition) effect is applied, and the video switches automatically.						

Front Panel

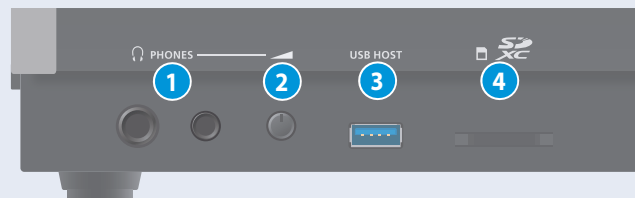

1 PHONES jack

Connect your headphones here.

2 [PHONES] knob

Adjusts the headphone volume.

3 USB HOST port

Connect USB storage such as a USB flash drive or an external SSD here, for backing up this unit's settings or importing materials from the storage device into this unit.

You can also connect your smartphone here to tether this unit to its Internet connection, or connect a USB numeric keypad for switching between videos.

4 SDXC card slot

Insert an SD card here.

This lets you record video and audio, back up this unit's settings and import material that's saved on the storage media.

Rear Panel

* To prevent malfunction and equipment failure, always turn down the volume, and turn off all the units before making any connections.

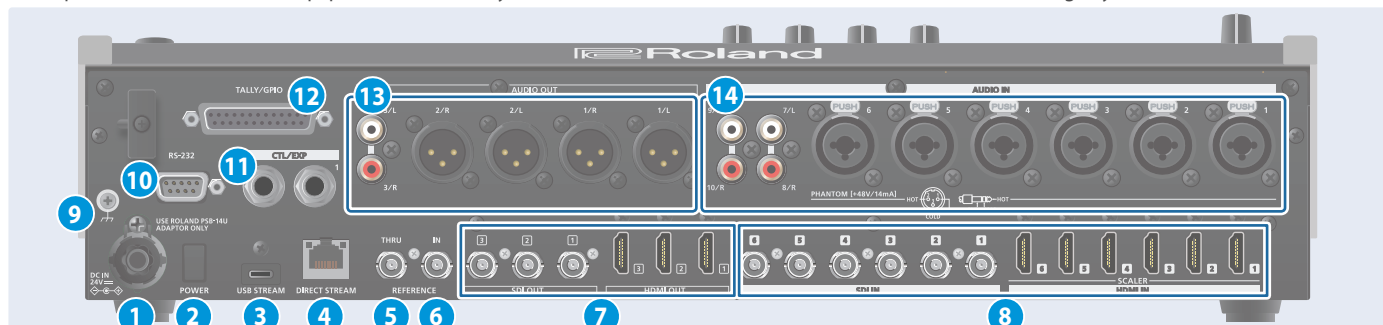

1 DC IN jack

Connect the included AC adaptor to this jack.

- * Use the cord hook to secure the cord of the AC adaptor as shown in the illustration. If you have trouble running the cord through, loosen the screw a little on the cord hook.

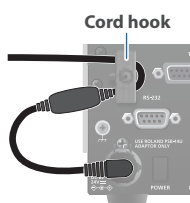

2 [POWER] switch

Turns the power on/off.

3 USB STREAM connector (USB Type-C®)

- Outputs the audio and video to your computer. This is also used to input audio played on your computer to the VR-120HD.
- Use the dedicated software to remotely control the VR-120HD from a computer or iPad that is connected.
- * If you are outputting HD video via USB, connect this to a USB 3.0 port of your computer.
- * Do not use a USB cable that is designed only for charging a device. Charge-only cables cannot transmit data.
- * If you connect via an extension cable or a USB hub, the computer might not recognize the VR-120HD.

4 DIRECT STREAM port

- Connect this port to a network device for livestreaming.
- Lets you remotely control the VR-120HD by using terminal software, etc.
- Use the dedicated software to remotely control the VR-120HD from a computer that's connected to this unit, or from an iPad that's connected via wireless LAN.
- Use the VR-120HD to remotely control a camera that is connected.
- Displays a tally on your wireless LAN connected iOS or Android device (this is the "smart tally" function).

NOTE

As this port supports GbE, use a LAN cable with a CAT5e specification or better.

5 REFERENCE THRU jack

Sends the synchronization signal that is inputted to the VR-120HD to an external device that is connected to this unit.

6 REFERENCE IN jack

Connect an external source device for synchronization in order to input a sync signal.

7 HDMI OUT 1–3 and SDI OUT 1–3 connectors

These connectors are for video output. Use the connectors that are appropriate for the connected devices. You can change the video bus assignment for each connector. With the factory settings, the bus assignments are as follows.

Connector	Bus
SDI/HDMI OUT 1	Program (final output video)
SDI/HDMI OUT 2	Preview (preview output video)
SDI/HDMI OUT 3	Multi-View (multi-view)

8 HDMI IN 1–6 connectors, SDI IN 1–6 connectors

These connectors are for video input. Use the connectors that are appropriate for the connected devices. The input format is detected automatically.

9 Ground terminal

Connect this to an external earth or ground, if necessary.

10 RS-232 connector

You can connect this to a computer equipped with an RS-232 connector to remotely control the VR-120HD.

11 CTL/EXP 1, 2 jacks

You can connect a footswitch (such as a BOSS FS-6, sold separately) or expression pedal (such as the EV-5, sold separately) to this jack. Use this when you want to switch between video using your foot.

- * Use only the specified expression pedal (Roland EV-5, EV-30, BOSS FV-500L/FV-500H; sold separately). Connecting expression pedals made by third-party manufacturers may cause this unit to malfunction.

12 TALLY/GPIO connector

Use this to connect to devices that have a tally indicator feature, or to connect to devices that have a control signal input/output function.

13 AUDIO OUT (XLR, RCA) jacks

These jacks output audio. Use the jacks that are appropriate for the connected devices.

For each jack, you can change the audio bus (Main, AUX 1, AUX 2, AUX 3, Monitor) that is assigned for output from that jack.

14 AUDIO IN 1–6 (XLR/TRS) jacks

Use these jacks for audio input. Connect mic or line-level analog audio equipment here.

* About phantom power

You can supply phantom power (+48 V) from the AUDIO IN 1–6 jacks (XLR). This should be switched on for condenser mics that require phantom power.

[MENU] button → "Audio Input" → "AUDIO IN 1" – "AUDIO IN 6", and set "PHANTOM +48V" to "On".

AUDIO IN 7/L, 8/R (LINE IN) jacks

AUDIO IN 9/L, 10/R (LINE IN) jacks

Use this connector for audio input. Connect analog audio equipment such as an audio mixer here.

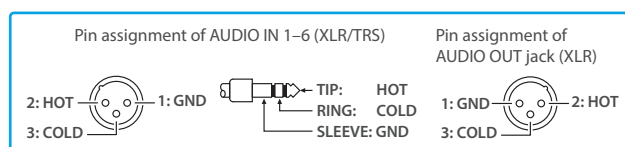

Connecting Bluetooth® Devices

Use the Bluetooth features of the VR-120HD to connect it to your Bluetooth-compatible mobile device. This lets you do the following:

- Input the audio signals from your Bluetooth audio device.
 - Use dedicated app "VR-120HD Remote" to remotely control the VR-120HD from an iPad (p. 106).
- * For more on connecting (pairing) with a dedicated app, see the app's Owner's Manual.

Registering a Bluetooth Audio Device (Pairing)

To connect a Bluetooth device to this unit, you must pair (register) the device with the unit.

Once you pair the device with this unit, there is no need to do it again.

- * To connect a Bluetooth device that's already paired, refer to "Connecting an Already-Paired Bluetooth Device" on this page.
- * See the Owner's Manual for the Bluetooth device you want to pair for details on the necessary operations.

1. Place the Bluetooth device nearby the VR-120HD.
2. Press the [MENU] button → "System" → select "Bluetooth Pairing".

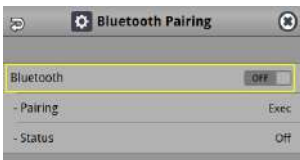

3. Press the [VALUE] knob to change the setting to "ON".
The VR-120HD's Bluetooth function turns on.
4. Use the [VALUE] knob to select "Pairing", and press the [VALUE] knob.

A confirmation message appears.



* If you decide to cancel, press the [EXIT] button.

5. Use the [VALUE] knob to select "OK", and press the [VALUE] knob.

Pairing begins.
The following message is shown when the unit is pairing.

"Now Pairing..."

6. Turn on the Bluetooth function of the Bluetooth device.
7. Display the Bluetooth device screen on your Bluetooth device, and select "Roland VR-120HD Audio".
Once pairing is successful, the message on the VR-120HD changes to "Completed".
8. Press the [MENU] button to close the menu.

Connecting an Already-Paired Bluetooth Device

1. Turn on the Bluetooth function of the Bluetooth device.
2. Turn on the Bluetooth function of the VR-120HD.
The onscreen Status display on the VR-120HD changes to "Connected" when the connection is successful.



* If connection does not succeed, select "Roland VR-120HD Audio" in the Bluetooth device screen on your Bluetooth device.

MEMO

- You can also check the  (Bluetooth) indicator for the connection status.

Lit	Connected	Rapid blinking	Now pairing
Unlit	Bluetooth off	Blinking	Waiting for connection

- Pair again in the following cases:
 - When the pairing data has been deleted from the Bluetooth device
 - When the VR-120HD has been reset to its factory-set state (p. 107).
- To remove the Bluetooth connection, deactivate Bluetooth on the VR-120HD or on your Bluetooth device.
- You can assign a function to a USER button for switching Bluetooth on/off, or for pairing (p. 97).

Connecting a Footswitch

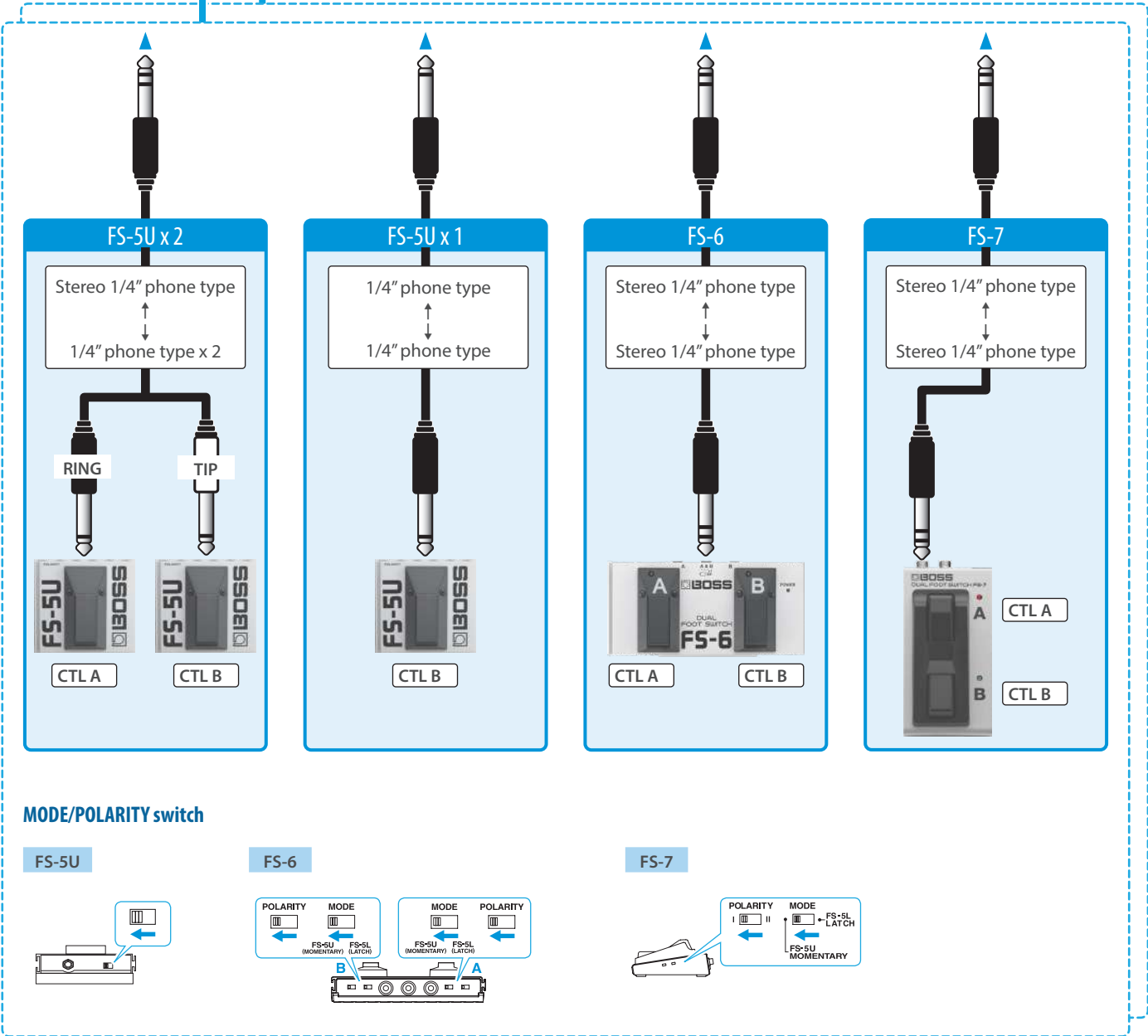

MODE/POLARITY switch

FS-5U

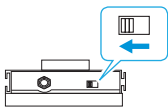

FS-6

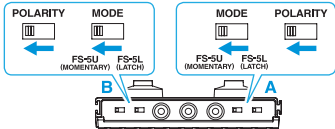

FS-7

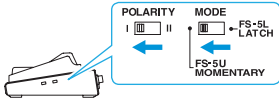

NOTE

The BOSS FS-6's A, B, and A&B jacks also act as the power switch. The power turns on when you insert a plug into the jack, and turns off when you remove the plug.
To prevent the batteries from running down, remove the plugs from the jacks when you're not using the BOSS FS-6.

Turning the Power On/Off

- * Before turning the unit on/off, always be sure to turn the volume down. Even with the volume turned down, you might hear some sound when switching the unit on/off. However, this is normal and does not indicate a malfunction.
- * Never turn off the power or remove the USB flash drive or SD card while the USB flash drive or SD card is being accessed.
- * This unit is not designed for continuous operation over long periods of time (one month or longer). If you want to use this unit over long periods of time, cycle the power periodically.

Turning the Power On

1. Make sure that all devices are powered-off.
2. Turn on the [POWER] switch of the VR-120HD.

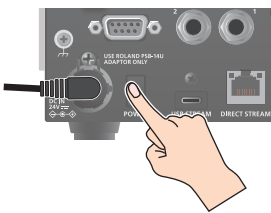

3. Turn on the power of the source devices.
Turn on the power of the source devices that are connected to the VR-120HD's input connectors, such as video cameras.
4. Turn on the power of the output devices.
Turn on the power of the devices that are connected to the VR-120HD's output connectors, such as projectors.

Turning the power off

1. Turn off the power of the output devices first, and then the source devices.
2. Turn off the [POWER] switch of the VR-120HD.
The following message appears.



3. Press the [VALUE] knob to finish shutting down.
If you wish to cancel, press the [POWER] switch again.

Operating the Menu

Here's how to access the menu, and make video/audio settings and settings for this unit.

1. Press the [MENU] button to display the menu.



The menu is organized into functions.

2. Turn the [VALUE] knob to select the menu item to edit, and press the [VALUE] knob to confirm.

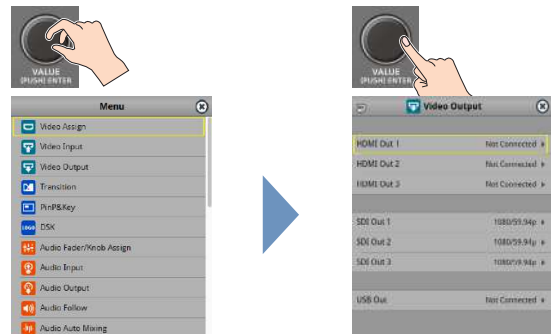

3. Repeat step 2 as needed.
Press the [EXIT] button to go back up one level.
4. Turn the [VALUE] knob to change the setting value, and then press the [VALUE] knob to confirm.
 - By turning the [VALUE] knob while pressing it, you can make larger changes to the value.
 - Long-pressing the [VALUE] knob returns the current menu item you're setting to its default value.
5. Press the [MENU] button to close the menu.

MEMO

You can also operate this unit by touching the icons on the menu screen.

A diagram showing touch navigation on the 'Video Assign' menu screen. Callouts indicate: 'Go back up one level' (top left icon), 'Close the menu' (top right icon), 'Select a menu item' (hand touching 'Input 2'), and 'Scroll through the menu items' (hand touching the list).

Operating the Setup Screen

The VR-120HD features a [SETUP] button for each section. Press the respective [SETUP] button to view the setup screen for that section, and use the touch panel to easily make important settings.

Use the menu when you want to access the detailed settings. (p. 108)

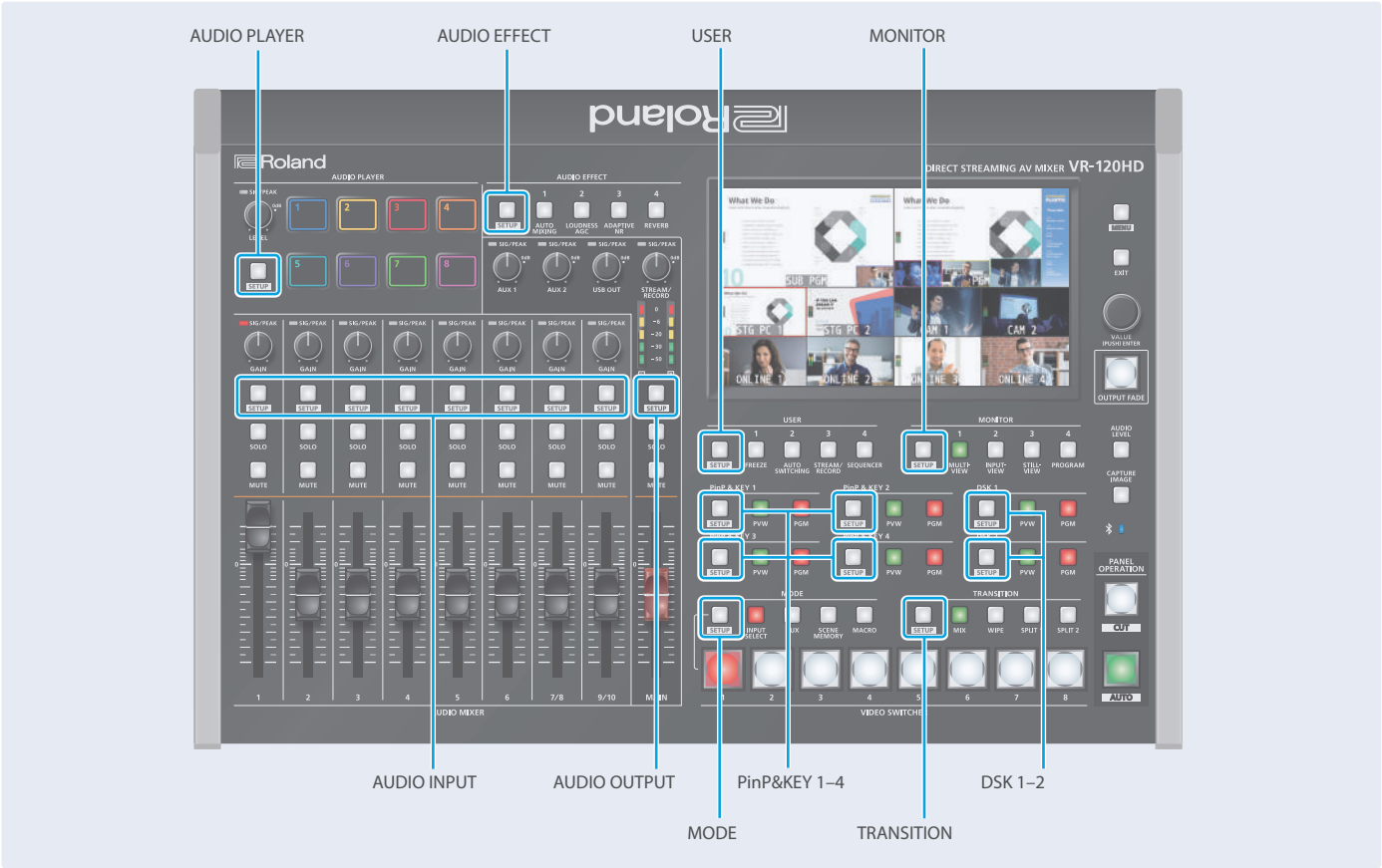

This explains how to operate the setup screens, with the MODE setup screen as an example.

1. With the [INPUT SELECT] button lit up, press the MODE [SETUP] button.

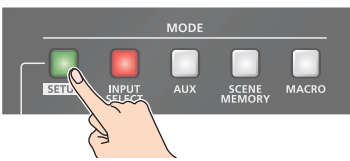

The setup screen corresponding to the current mode is shown.

2. Touch the screen to change the parameter values and to switch between pages.

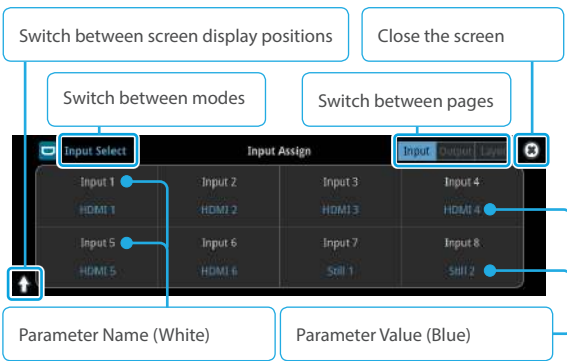

- When you switch between pages, different parameters are shown.
- When you change modes using a MODE button or by other means, the setup screen is shown for the respective mode.

Touch the parameter values (shown in blue) on the screen to see a list of parameter values that can be set. To change a value, scroll the list and touch the value you want to set.



- A check mark is shown to the right of the current value.
 - Press the [EXIT] button to close the list.
3. Press the MODE [SETUP] button to close the setup screen.
- You can also close the screen by touching the “close” icon at the top right-hand corner.

MEMO

You can use the [MENU] button, [VALUE] knob and [EXIT] button to make the settings without using the touch panel. As with the menu, turn the [VALUE] knob to select the parameter or value to edit, and press the [VALUE] knob to confirm. Move the yellow box (cursor) to select the parameters.

Switching the Monitor View

Aside from multi-view display, you can switch between videos to monitor such as the input video or a list of still images, according to your needs.

1. Press one of the MONITOR [1], [2], [3] or [4] buttons.

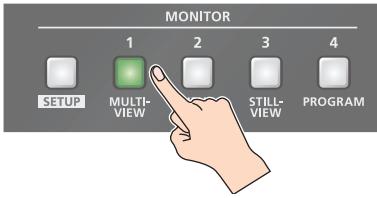

MONITOR [1] (MULTI-VIEW) button

The final output video, preview output video and the videos allocated to the cross-point [1]–[8] buttons are shown in sections of the display (multi-view).



1 PVW (preview) section

Displays the preview output video (the video to be output next).

* The fade-in/out effect (p. 35) is not reflected here.

2 PGM (program) section

Displays the final output video.

3 VIDEO SWITCHER [1]–[8] button video

Displays the video assigned to each VIDEO SWITCHER button.

The final video output and preview output video are displayed with tally frames (red and green).



1 External Rec indicator

If a camera that supports the REC status function is connected, this is shown when the camera's REC button is pressed.

2 AUX/Source indicator

This displays as follows.

Yellow	PinP & KEY inset screen
Magenta	DSK video source
Green	AUX bus video source

4 Setup screen

You can use the touch panel to edit the settings.

MONITOR [2] (INPUT-VIEW) button

The input video from the HDMI IN connectors and the SDI IN connectors are shown as 16 separate sections on the screen.

MONITOR [3] (STILL-VIEW) button

Shows the loaded still images in 16 separate sections on the screen.

MONITOR [4] (PROGRAM) button

Shows the final output video.

[SETUP] button

Shows the setup screen.

Audio level meter indication

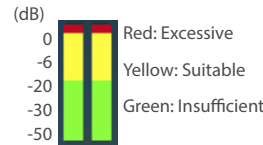

- You can set the audio level meter to show or hide.

Configure the settings of the following menu items from the [MENU] button → "SYSTEM".

Menu item	Explanation
Audio Level Meter	
Multi-View	Sets whether to show or hide the audio level meter.
Input-View	

MEMO

- You can change the left-right videos that are shown in the upper part of the multi-view.
Set this by pressing the [MENU] button → "System" → "Multi-View Layout" and select "Left" or "Right".
- You can press the MONITOR [2] (INPUT-VIEW) button to change a video that's displayed.
Set this by pressing the [MENU] button → "System" → "Input-View Layout".
- You can change the monitoring videos assigned to the MONITOR [1]–[4] buttons.
To make this setting, use the [MENU] button → "System" → "Monitor Assign" → "Monitor 1"–"Monitor 4".
- Items shown on the monitor**
You can individually set whether items like the tally frame, label and so on are shown or hidden.
Configure the settings of the following menu items from the [MENU] button → "System".

Menu item	Explanation
Tally Frame	Tally frame
AUX/Source Indicator	AUX/Source indicator
External Rec Indicator	External Rec indicator
Audio Level Meter	Audio level meter
Preview Label	Label

- You can change the label names that are shown in the monitor.
Edit this from the [MENU] button → "System" → "Preview Label" → "Label Edit".
- For details on the cameras that support the REC status function, refer to the Roland website.

<https://proav.roland.com/>

About SD Card

Using an SD card lets you do the following.

- Record video or audio
- Load video or audio files
- Import/export still images or setting files

SD cards that can be used on the VR-120HD



SDXC card can be used on the VR-120HD.

Some SD card types or SD cards from some manufacturers may not properly record audio/video with the VR-120HD.

Refer to the support page on the Roland website for the latest information on compatibility.

<https://roland.cm/vr-120hd>



NOTE

Before you can use a commercially available SD card with the VR-120HD, you must format it as described in "Formatting an SD Card".

Inserting the SD Card

1. Push the SD card all the way into the SDXC card slot until you hear a click.

NOTE

Ensure that the SD card is oriented correctly, and insert it all the way into the port. Do not forcibly push the card into place.



Formatting an SD Card

1. Press the [MENU] button → "SD Card/USB Memory" → select "Format" and press the [VALUE] knob.

A confirmation message appears.

2. Select "OK" and press the [VALUE] knob.

The SD card is now formatted.

Removing an SD Card

1. Press the [MENU] button → "SD Card/USB Memory" → "SD Card" select "Eject" and press the [VALUE] knob.

2. Select "OK" and press the [VALUE] knob.

Once the message "The SD Card is safe to remove" is displayed on the screen, you can safely remove the card.

3. Push the SD card further into the slot.

4. Hold the SD card and pull it out towards you.

NOTE

- SD cards or USB flash drives that are formatted on a different device might not work normally on the VR-120HD. Be sure to format the media on the VR-120HD (SD card: exFAT format, USB flash drive: FAT32 format).
- Never turn off the power or remove the SD card or USB flash drive while the message "Processing..." is shown.
- Formatting the media erases all data saved on the SD card or USB flash drive (such as recorded video, audio and still image data). If the storage media contains important data, back the data up to your computer before you format it.

About USB Flash Drive

Using a USB flash drive lets you do the following.

- Load video or audio files
- Import/export still images or setting files

USB Flash Drives that can be used on the VR-120HD

Use a commercially available USB flash drive.

NOTE

Before you can use a commercially available USB flash drive with the VR-120HD, you must format it as described in "Formatting a USB Flash Drive".

Formatting a USB Flash Drive

1. Connect the USB flash drive to the USB HOST port.

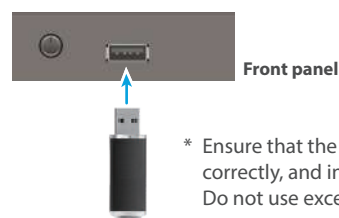

* Ensure that the USB flash drive is oriented correctly, and insert it all the way into the port. Do not use excessive force.

2. [MENU] button → "SD Card/USB Memory" → "USB MEMORY" → select "Format", and press the [VALUE] knob.

A confirmation message appears.

* If you decide to cancel, press the [EXIT] button.

3. Use the [VALUE] knob to select "OK", and press the [VALUE] knob.

USB Memory is now formatted.

Removing a USB Flash Drive

1. Press the [MENU] button → "SD Card/USB Memory" → "USB Memory" select "Eject" and press the [VALUE] knob.

2. Select "OK" and press the [VALUE] knob.

Once the message "The USB Memory is safe to remove" is displayed on the screen, you can safely remove the card.

3. Unplug the USB flash drive.

Video Input/Output Settings

Setting the Video Input/Output Format

Here's how to specify the input/output format as appropriate for the device that's connected.

Setting the System Format

On the VR-120HD, the input/output format is determined according to the system format. You set the input/output format to match the connected equipment.

System format	Input format (*1)	Output format	
	HDMI IN 1–6 connectors SDI IN 1–6 connectors	HDMI OUT 1–3 connectors SDI OUT 1–3 connectors	USB STREAM port DIRECT STREAM port
1080p	1080p, 1080i	1080p, 1080i	1080p, 720p
720p	720p	720p	720p

(*1) The HDMI IN 1–6 connectors are compatible with multiple formats (when using the factory settings). You can configure a different input format for each connector, regardless of the system format. Refer to "Setting the Input Format for the HDMI IN 1–6 Connectors" on this page for details.

1. [MENU] button → "System" → "Output Format" → select "System Format", and press the [VALUE] knob.

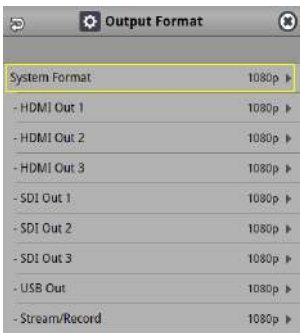

2. Use the [VALUE] knob to select "1080p", or "720p", and press the [VALUE] knob.

* A change in the setting is not applied until you press the [VALUE] knob to confirm.

3. Press the [MENU] button to close the menu.

Internal processing

The VR-120HD's internal processing is progressive. Interlaced input video is automatically converted to a progressive signal.

The video might appear jagged at this time, or the video in a PinP inset screen or on the multi-view might waver.

This is due to progressive conversion, and is not a malfunction.

About frame rate

Set the frame rate for the VR-120HD from the [MENU] button → "System" → Frame Rate.

* Set the frame rate for USB Out from the [MENU] button → "System" → Frame Rate "USB Out".

* Set the frame rate for streaming and for video recording from the [MENU] button → "System" → Frame Rate "Stream/Record".

Setting the Input Format for the HDMI IN 1–6 Connectors

Using the factory settings, the EDID assignment for the HDMI IN 1–6 connectors is "Internal" (so that EDID values of all formats that can be input are sent).

To specify an input format of your choice, change the setting of the EDID information being sent so that it matches the incoming video signal.

What is EDID?

EDID is data that is transmitted from the VR-120HD to the source device when the VR-120HD is connected to a source device. EDID contains data such as the formats that can be input to the VR-120HD

(resolution, color space, color depth) and audio information.

Based on the EDID information that the source device receives, it will output the most appropriate video format to the VR-120HD.

1. [MENU] button → "Video Input" → "HDMI In 1 (Scaler)" – "HDMI In 6 (Scaler)" → select "EDID" and press the [VALUE] knob.

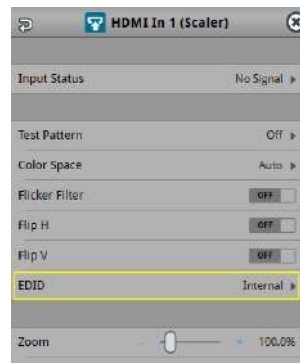

2. Use the [VALUE] knob to set the input format (the EDID information to send), and press the [VALUE] knob.

* A change in the setting is not applied until you press the [VALUE] knob to confirm.

Value	
INTERNAL (EDID information for all input table formats is sent.)	
SXGA+ (1400 x 1050)	UXGA (1600 x 1200)
SVGA (800 x 600)	WUXGA (1920 x 1200)
XGA (1024 x 768)	720p
WXGA (1280 x 800)	1080i
FWXGA (1366 x 768)	1080p
SXGA (1280 x 1024)	

3. Press the [MENU] button to close the menu.

Assigning Video Sources

Here's how to assign the video sources (input video, still images and video player) to the VIDEO SWITCHER [1]–[8] buttons.

1. With the [INPUT SELECT] button lit up, press the MODE [SETUP] button.

The setup screen appears.

2. Touch the screen to select the video source.

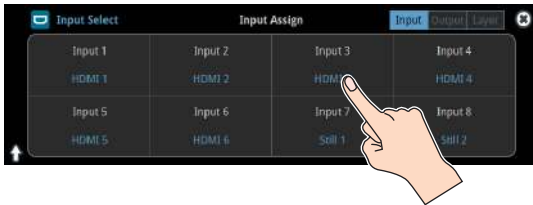

Video Source	Explanation
HDMI 1–6	Video for HDMI IN connectors 1–6
SDI 1–6	Video for SDI IN connectors 1–6
Still 1–16	Still images 1–16
V.Player/SRT In	Video from video player/SRT input
Stream/Record Status 1, 2	Status display
Date&Time	Date and time (analog or digital clock) The analog/digital display changes in the "System → Date&Time → Clock Display Type" setting.
N/A	No video source

* You can't switch the video to a channel to which Stream/Record Status 1, 2, Date&Time or N/A is assigned. If you switch the assignment for one of the VIDEO SWITCHER [1]–[8] buttons that are now outputting, the output video switches to a black screen.

MEMO

You can import still images by using the following methods.

- ➔ "Loading a Still Image from a Storage" (p. 27)
- ➔ "Capturing a Still Image from Input/Output Video" (p. 28)

Adjusting Output Video

Here's how to adjust the output image appropriately for the device that's receiving the VR-120HD's output.

1. [MENU] button → "Video Output" → select "HDMI Out 1–3"; "SDI Out 1–3"; or "USB Out" and press the [VALUE] knob.

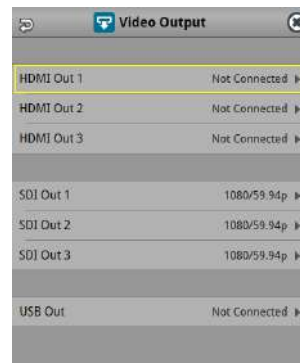

2. Use the [VALUE] knob to select a menu item shown below, and press the [VALUE] knob.

HDMI Out 1–3

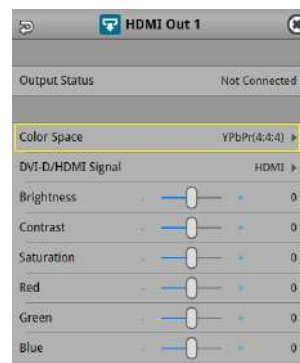

Menu item	Explanation
Output Status	Shows the format and an HDCP signal presence.
Color Space	Specifies the color space.
DVI-D/HDMI Signal	Specifies the type of output signal.
Brightness	Adjusts the brightness.
Contrast	Adjusts the contrast.
Saturation	Adjusts the saturation.
Red	Adjusts the red level.
Green	Adjusts the green level.
Blue	Adjusts the blue level.
External Rec Control	Turns the External Rec control on/off.

SDI Out 1-3

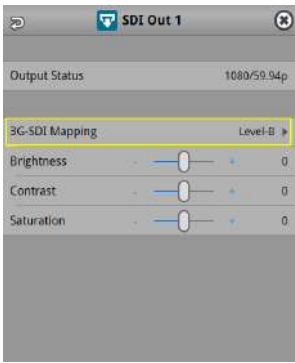

Menu item	Explanation
Output Status	Shows the format and an HDCP signal presence.
3G-SDI Mapping	Specifies the mapping structure of the 3G-SDI output.
Brightness	Adjusts the brightness.
Contrast	Adjusts the contrast.
Saturation	Adjusts the saturation.

USB Out

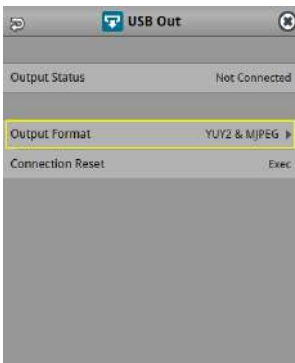

Menu item	Explanation
Output Status	Shows the connection status and whether or not an HDCP signal is present.
Output Format	Sets the output destination formats that can be selected from the livestreaming app.
Connection Reset	Reconnects the computer and the VR-120HD when the video is garbled or when operation is otherwise unstable.

- Use the [VALUE] knob to edit the value of the setting, and press the [VALUE] knob.
- Press the [MENU] button to close the menu.

MEMO

You can output a test pattern, useful for adjusting the image quality of a display.

Use the [MENU] button → "System" → "Test Pattern" to specify the test pattern.

Adjusting Input Video

Here's how to adjust the quality of the input video signals.

For the HDMI IN 1-6 connectors, you can also adjust the scaling.

- [MENU] button → "Video Input" → select "HDMI In 1-6 (Scaler)"; or "SDI In 1-6" and press the [VALUE] knob.

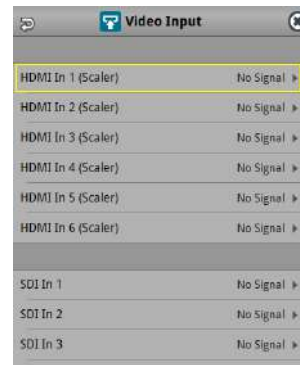

- Use the [VALUE] knob to select a menu item shown below, and press the [VALUE] knob.

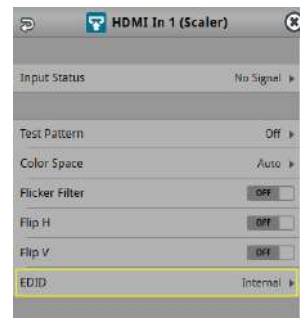

Menu item	Explanation
Input Status	Displays information about the incoming video.
Flip H	When this is "ON", the video is input with left and right flipped.
Flip V	When this is "ON", the video is input with top and bottom flipped.
Brightness	Adjusts the brightness.
Contrast	Adjusts the contrast.
Saturation	Adjusts the saturation.

* The following parameters are only for HDMI IN 1-6 (Scaler).

Test Pattern	Specifies the test pattern.
Color Space	Specifies the color space.
Flicker Filter	When this is "ON", flickering is reduced.
EDID	Specifies the input format (EDID) (p. 14).
Zoom	Adjusts the zoom ratio.
Scaling Type	Specifies the scaling type.
Manual Size H	Adjusts the horizontal size when scaling type is set to "MANUAL".
Manual Size V	Adjusts the vertical size when scaling type is set to "MANUAL".
Position H	Adjusts the position in the horizontal direction.
Position V	Adjusts the position in the vertical direction.
Red	Adjusts the red level.
Green	Adjusts the green level.
Blue	Adjusts the blue level.

- Use the [VALUE] knob to edit the value of the setting, and press the [VALUE] knob.
- Press the [MENU] button to close the menu.

Assigning Video Buses to Output Connectors

The VR-120HD features seven types of video buses. You can assign the signals from each video output connector/port (HDMI OUT 1–3 connectors, SDI OUT 1–3 connectors, USB STREAM port, DIRECT STREAM port) and the video shown on this unit's display to the desired video bus.

Video output connectors and ports	
HDMI Out 1–3	HDMI OUT 1–3 connectors
SDI Out 1–3	SDI OUT 1–3 connectors
USB Out	USB STREAM port
Stream/Record	DIRECT STREAM port
LCD Monitor	This unit's display

Video bus	Explanation
Program	Final output video
Sub Program	Same video as the PROGRAM bus The SUB PROGRAM bus lets you set whether to display or hide the PinP & key layers and the DSK layers, separately from the PROGRAM bus. You can edit the layer settings to output a different video from that of the PROGRAM bus.
Preview	Preview output video (the video to be output next) * The fade-in/out effect (p. 35) is not reflected here.
AUX 1–3	Video of your choice sent to the AUX 1–3 bus (p. 18) This lets you allocate a separate output that is independent of the final output, such as when you want a specific input video to be a fixed output.
Multi-View	The final output video, preview output video and the videos allocated to the VIDEO SWITCHER [1]–[8] buttons (multi-view) MEMO You can change the respective videos that are shown. Set this by pressing the [MENU] button → "System" → "Multi-View Layout" and select "Left" or "Right".
Input-View	The input video from the HDMI IN and SDI IN connectors (shown as 16 separate sections on the screen) MEMO You can change the videos that are shown. Set this by pressing the [MENU] button → "System" → "Input-View Layout".
Still-View	Still images loaded into the unit (shown as 16 separate sections on the screen)

1. With the [INPUT SELECT] button lit up, press the MODE [SETUP] button.

The setup screen appears.

2. Touch the page tab at the top right-hand part of the screen to select page 2 (Output).



The Output Assign screen appears.

3. Touch the screen to select the video bus to assign.

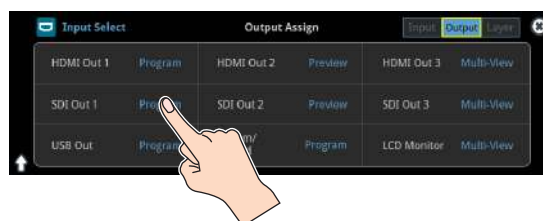

MEMO

Assigning the video buses and audio outputs

You can also assign the desired audio buses (Main bus, AUX 1–3 bus, Monitor bus) for each jack, apart from the video bus (p. 64).

Selecting the Video Sent to the AUX 1–3 Bus

Here's how to send the video of your choice to the AUX 1–3 bus. This lets you allocate a separate output that is independent of the final output, such as when you want a specific input video to be a fixed output.

1. Press the [AUX] button.

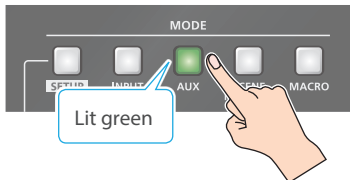

2. Press the VIDEO SWITCHER [1]–[8] buttons to select the video signal to send to the AUX 1 bus.

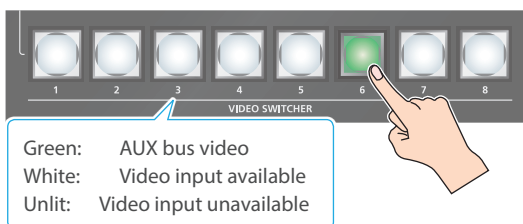

The video is switched for the output connector to which the AUX 1 bus is assigned.

MEMO

You can also directly touch the Multi-View, Input-View or Still-View screens to select a video signal. If you touch the screen directly to select a video, the VIDEO SWITCHER [1]–[8] buttons may not light up green in some cases.

Configuring on the setup screen

1. With the [AUX] button lit up, press the MODE [SETUP] button.

The setup screen appears.

2. Touch the screen to select the video signal to send to the AUX 1–3 bus.

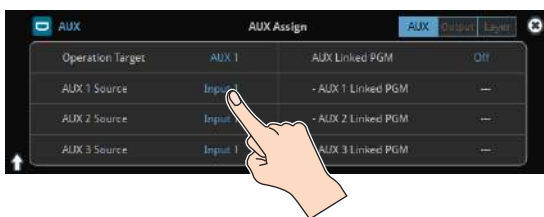

MEMO

- You can adjust how much audio is sent to the AUX bus.
 - ➔ "Sending Audio to the AUX Bus" (p. 64)
- Sending the same video as the final output to the AUX bus (AUX link)**

You can use the AUX link function to send the same video as the final output video to the AUX bus. The video sent to the AUX bus automatically switches in tandem with the video transitions. From the [MENU] button → "System", set the "AUX Linked PGM" to "Auto Link" or "Manual Link" (p. 162).
- You can also set the button to operate a source besides AUX 1.
 - From the [MENU] button → "System", set the "AUX Operation Target" to "AUX 2" or "AUX 3" (p. 162).

Inputting Copy-Protected (HDCP) Video

If you want to input HDCP-protected video from a BD player or other device, you can enable HDCP input.

- * If you want to output copy-protected (HDCP) video or audio, connect a device that supports HDCP.

What's HDCP?

HDCP is copyright-protection technology that prevents unlawful copying of content by encoding the path when sending digital signals from a video playback device to a display monitor or other display equipment.

1. [MENU] button → "System" → select "HDCP", and press the [VALUE] knob.

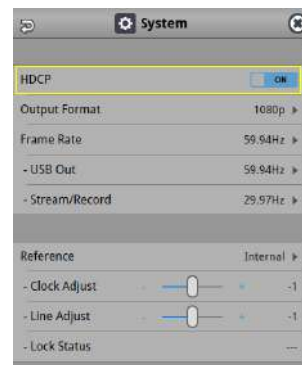

Value	Explanation
ON	Copy-protected (HDCP) video can be input. HDCP is also added to the video that is output. * Video/audio from the SDI OUT connectors and the USB STREAM port are not outputted.
OFF	Copy-protected (HDCP) video cannot be input.

2. Press the [MENU] button to close the menu.

Checking for HDCP-capable devices

Source devices

You can check the HDCP support status of the source device from the menu.

Use the [MENU] button → "Video Input" → "HDMI In 1–6 (Scaler)" → "Input Status" to display the HDCP status.

When inputting copy-protected (HDCP) video, "DETECT" is displayed.

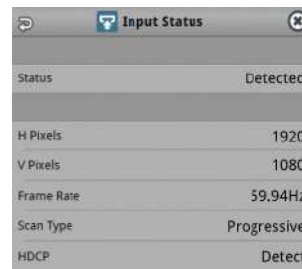

Output devices

If a device that supports HDCP is connected, "HDCP" is displayed when you press the [MENU] button and select "Video Output" → "HDMI OUT 1–3" → "Output Status".

Specifying a Reference Clock

You can specify a clock to which operation of the VR-120HD is referenced (a reference clock).

1. [MENU] button → “SYSTEM” → select “Reference”, and press the [VALUE] knob.

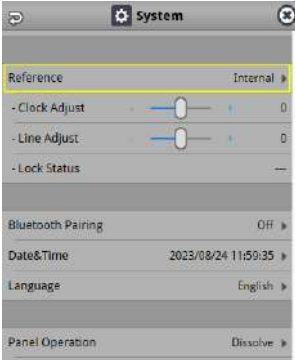

2. Use the [VALUE] knob to specify the reference clock, and press the [VALUE] knob.

Value	Explanation
Internal	The VR-120HD's internal clock is used as the reference clock.
External	A synchronizing signal input via the REFERENCE IN connector is used as the reference clock. Black-burst (frame synchronization), bi-level, and tri-level synchronizing signals are supported.
SDI 1-6	A signal input via one of the SDI IN 1-6 connectors is used as the reference clock. The VSYNC (vertical synchronizing) signal output from the VR-120HD is synchronized to the VSYNC signal input via SDI.

When set to “External” or “SDI 1-6”

Adjust the following menu items as needed.

Menu item	Explanation
Clock Adjust	This adjusts the phase horizontally. Adjust this when output is horizontally out of sync with the operation of other devices using the same clock.
Line Adjust	This adjusts the phase vertically. Adjust this when output is vertically out of sync with or field-shifted from the operation of other devices using the same clock.

3. Press the [MENU] button to close the menu.

Video Operations

Switching the Video

You can switch between the videos of the PGM bus and PST bus to specify the final output.

Setting the Operation Mode

There are two operation modes for switching between videos: "Dissolve" and "PGM/PST".

Dissolve mode (factory setting)

This mode selects the video to output and immediately outputs it to the PGM bus.

Press the [CUT] or [AUTO] button to select what happens when you switch between videos (the buttons light up green when pressed).

PGM/PST mode

In this mode, the PST video is displayed in the PVW bus, and you can check the video before outputting it to the PGM bus.

Press the VIDEO SWITCHER [1]–[8] buttons to select a PST video (the buttons light up green). The content is shown in the PVW bus.

1. [MENU] button → "System" → select "Panel Operation", and press the [VALUE] knob.

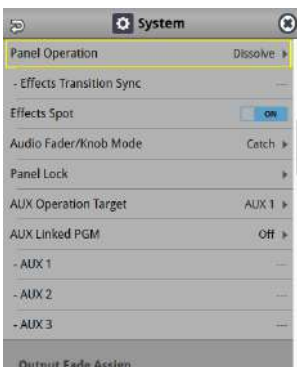

2. Use the [VALUE] knob to select "Dissolve", or "PGM/PST", and press the [VALUE] knob.
3. Press the [MENU] button to close the menu.

Switching in the Dissolve Mode

This explains what to do when selecting "Dissolve mode" (p. 20) in the operation mode settings.

1. Press the [MIX] or [WIPE] button to select the transition effect.



MIX

The two videos are mixed as the transition occurs.



WIPE

The next video moves across to replace the original video.



2. Press the MODE [INPUT SELECT] button.
3. Press the [CUT] or [AUTO] button.



4. Press the VIDEO SWITCHER [1]–[8] buttons, and then select the video signal to output.

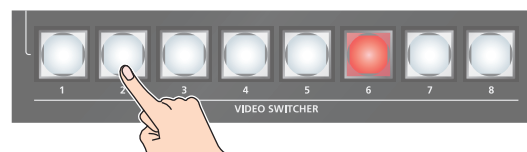

Button to operate	Action taken when pressed
VIDEO SWITCHER [1]–[8] button	When [CUT] button is lit up green
	The video switches instantly.
	When [AUTO] button is lit up green
	A switch (transition) effect is applied, and the video switches automatically.

* During the transition effect, the selected VIDEO SWITCHER button blinks red, and then remains lit up red when the transition effect finishes.

MEMO

You can also directly touch the Multi-View, Input-View or Still-View screens to select a video signal.

Switching in the PGM/PST Mode

Here are the steps when selecting "PGM/PST mode" in the operation mode settings.

1. Press the [MIX] or [WIPE] button to select the transition effect.



2. Press the MODE [INPUT SELECT] button.
3. Press a VIDEO SWITCHER [1]–[8] button to select the preview output video (the video to be output next).

You can check the preview output video in the PVW section of the multi-view.

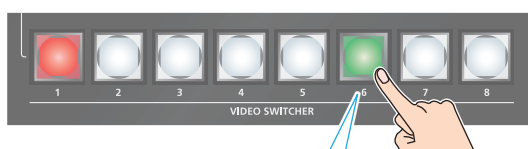

Lit Green: Preview output video (the video to be output next)

MEMO

You can also directly touch the Multi-View, Input-View or Still-View screens to select a video signal.

4. Press the [CUT] or [AUTO] button.



Button to operate	Action taken when pressed
[CUT] button (lit up red)	The video switches instantly.
[AUTO] button (blink red)	A switch (transition) effect is applied, and the video switches automatically. Set the video transition time from the [MENU] button → "Transition" → "Mix" → "Mix Time" or [MENU] button → "Transition" → "Wipe" → "Wipe Time".

MEMO

You can change the transition pattern by which the mix/wipe occurs.

- ➔ "Changing the Mix Pattern" (p. 21)
- ➔ "Changing the Wipe Pattern" (p. 21)

Changing the Mix Pattern

You can change the transition pattern used for a mix transition.

1. With the [MIX] button lit up, press the TRANSITION [SETUP] button.

The setup screen appears.

2. Touch the screen to access the settings.

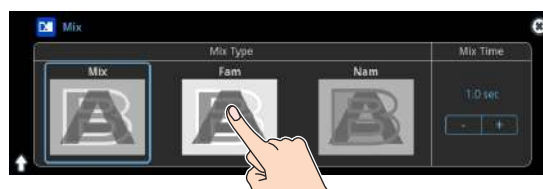

Menu item	Explanation
Mix Type	Specifies the transition pattern for mix.
Mix Time	Specifies how long the transition takes.

* For details on the parameters, refer to "4: Transition" (p. 112).

3. Press the [SETUP] button to close the screen.

Changing the Wipe Pattern

You can change the wipe transition pattern, wipe direction and other properties.

1. With the [WIPE] button lit up, press the TRANSITION [SETUP] button.

The setup screen appears.

2. Touch the screen to access the settings.

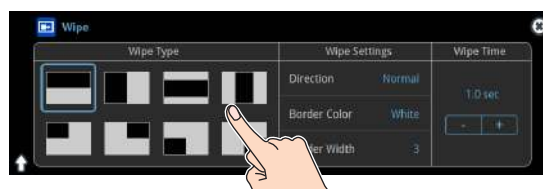

Menu item	Explanation
Wipe Type	Specifies the transition pattern for wipe.
Wipe Time	Specifies how long the transition takes.
Direction	Specifies the direction of wipe.
Border Color	Specifies the color of the border added to the edge of the wipe area.
Border Width	Specifies the width of the border added to the edge of the wipe area.

* For details on the parameters, refer to "4: Transition" (p. 112).

3. Press the [SETUP] button to close the screen.

Splitting the Video

Here's how to composite two videos in dividing the screen into left/right or upper/lower.

Positioning a video

- Left or upper: Video on the PGM bus
- Right or lower: Video on the PST bus



Configuring the Screen Layout

You can configure the screen layout separately for the TRANSITION [SPLIT 1] and [SPLIT 2] buttons.

- While [SPLIT 1] or [SPLIT 2] are lit up, press the TRANSITION [SETUP] button.

The Split setup screen appears.

- Touch the screen to access the settings.

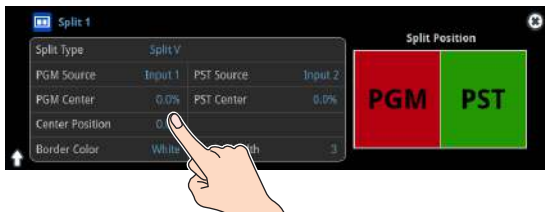

Value	Explanation
Split Type	Split V This vertically crops the center section of the video (split left/right).
	Split H This horizontally crops the center section of the video (split upper/lower).
PGM Source	Selects the video source to display on the left or upper side.
PST Source	Selects the video source to display on the right or lower side.
PGM Center	Adjusts the position of the video that is shown in the left or upper side.
PST Center	Adjusts the position of the video that is shown in the right or lower side.
Center Position	Adjusts the position of the boundary.
Border Color	Specifies the color of the border.
Border Width	Adjusts the width of the border.

* For details on the parameters, refer to p. 112.

MEMO

When the split setup screen is shown, you can edit the parameters such as Center Position, PGM Center and PST Center by directly dragging on the screen.

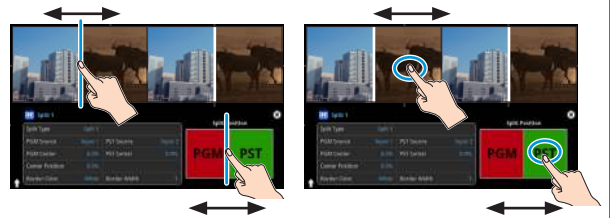

- Press the [SETUP] button to close the screen.

Displaying the Split

- Press the [SPLIT 1] or [SPLIT 2] button to turn on split compositing (the button lights up).

The SPLIT button lights up red.

- Press a VIDEO SWITCHER [1]–[8] button to select the video you want to display upper or on the left.

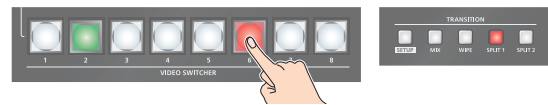

The video on the PGM side is selected when the SPLIT button is lit up red.

MEMO

You can also directly touch the Multi-View, Input-View or Still-View screens to select a video signal.

- Press the [SPLIT 1] or [SPLIT 2] button again.

The SPLIT button lights up green.

- * The button's lit color switches between red and green each time you press the SPLIT button.

- Press a VIDEO SWITCHER [1]–[8] button to select the video you want to display lower or on the right.

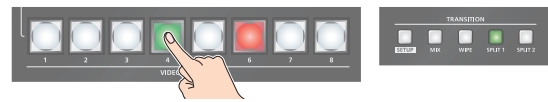

The video on the PST side is selected when the SPLIT button is lit up green.

MEMO

You can also directly touch the Multi-View, Input-View or Still-View screens to select a video signal.

- To turn off the split, press the [MIX] or [WIPE] button.

Switching the Video Automatically (Auto Switching)

The video of Input 1–8 or of scene memories (p. 78) can be switched automatically (the auto switching function).

You can make operation easier by letting the video switch automatically.

About the Operation Mode

Auto switching provides six operation modes that you can select as appropriate for your situation: “input scan”, “scene memory scan”, “beat sync”, “video follows audio”, “PinP&Key scan”, and “DSK scan”.

Switching at a specified interval (input scan)

This automatically switches the Input 1–8 video when a specified length of time elapses. You can change the duration that each video is shown, and also switch randomly between videos.

This is convenient when you want to switch between video signals of multiple cameras, for example when live-streaming a singer-instrumentalist.

* If there is no video input, this is skipped.

Switching scene memories (scene memory scan)

This automatically recalls between scene memories 1–32. The video and audio are switched according to the settings that are saved in each scene memory.

* Scene memories in which no settings have been saved are skipped.

Switching in sync with the beat of the music (beat sync)

This detects the beat of the song, and automatically switches the video at intervals of the beat.

This lets you create video transitions that are synchronized with the music, for example when live-streaming a DJ performance or a musical performance.

Switching according to the mic volume (video follows audio)

This detects the audio that is input from a mic, and automatically switches to the specified video according to the volume.

For example, if you’re streaming a talk show or a conversation, you can use this to switch between a close-up of the individual who is speaking and a wide shot of both people when neither person is speaking.

Switching between picture-in-picture (PinP) content (PinP & Key scan)

The inset screen video automatically changes after a specified length of time. You can change how long each video is shown and switch randomly between videos.

Switching between downstream keyer (DSK) content (DSK scan)

The caption video automatically changes after a specified length of time. You can change how long each video is shown and switch randomly between videos.

Turning the Auto Switching Function On/Off

MEMO

By assigning auto-switching functions to the USER buttons, you can use the buttons to turn functions on/off and configure the settings from the setup screen.

* The on/off function for auto-switching is assigned to the USER [2] button by factory default.

1. Press the USER [2] (AUTO SWITCHING) button to turn the auto-switching function on (the button lights up).

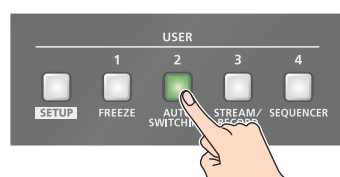

The video automatically switches according to the operating mode.

2. To turn the auto-switching function off, press the USER [2] (AUTO SWITCHING) button again.

Setting the Operation Mode

1. Press the USER [SETUP] button.

The User Assign screen appears.

2. Touch User 2 <Setup>.

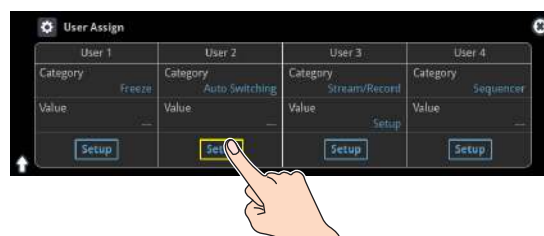

The Auto Switching setup screen appears.

3. Touch <Type> to select the operating mode.

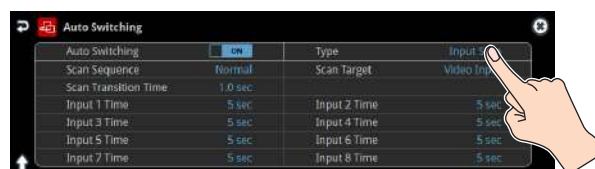

4. Press the [SETUP] button to close the screen.

Input scan

1. On the setup screen for the auto-switching function, touch <Type> to select "Input Scan".

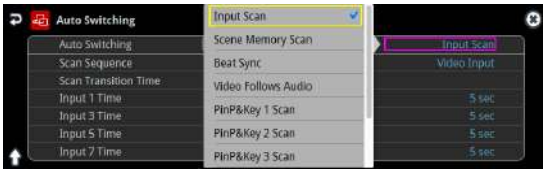

The setup screen changes accordingly.

2. Touch the screen to access the settings.

Menu item	Explanation
Scan Sequence	Specifies the order in which video signals are shown. Normal: Switches in the order of Input 1→8. Reverse: Switches in the order of Input 8→1. Random: Switches randomly.
Scan Target	Sets the video to which auto switching is applied. Video Input: Final output video and preview video PinP & Key 1-4: PinP and key layer (inset screen) video DSK 1-2: DSK layer (inset screen) video
Scan Transition Time	Specifies the video transition time.
Input 1-8 Time	Specifies the time that the video is shown. Turn this "Off" to skip.

* For details on the parameters, refer to "21: Auto Switching" (p. 152).

3. Press the [SETUP] button to close the screen.

Scene memory scan

1. On the setup screen for the auto-switching function, touch <Type> to select "Scene Memory Scan".



The setup screen changes accordingly.

2. Touch the screen to access the settings.

Menu item	Explanation
Scan Sequence	Specifies the order in which scene memories are switched. Normal: Switches in the order of scene memory 1→32. Reverse: Switches in the order of scene memory 32→1. Random: Switches randomly.
Memory 1-32 Time	Specifies the time it takes to switch to the next scene memory. Turn this "Off" to skip.

* For details on the parameters, refer to "21: Auto Switching" (p. 152).

3. Press the [SETUP] button to close the screen.

Beat sync

1. On the setup screen for the auto-switching function, touch <Type> to select “Beat Sync”.

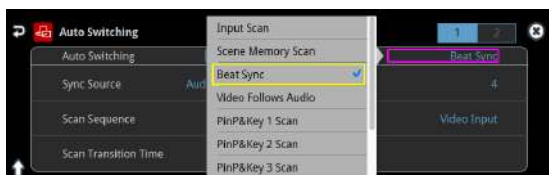

The setup screen changes accordingly.

2. Touch the screen to access the settings.

Menu item	Explanation
Sync Source	Specifies the input audio that synchronizes the video.
Scan Sequence	Specifies the order in which video signals are shown. Normal: Switches in the order of Input 1→8. Reverse: Switches in the order of Input 8→1. Random: Switches randomly.
Scan Transition Time	Specifies the video transition time.
Scan Cycle	Specifies the number of beats at which to switch to the next video.
Scan Target	Sets the video to which auto switching is applied. Video Input: Final output video and preview video PinP & Key 1-4: PinP and key layer (inset screen) video DSK 1-2: DSK layer (inset screen) video

* For details on the parameters, refer to “21: Auto Switching” (p. 152).

3. Press the [SETUP] button to close the screen.

MEMO

When an auto-switching function is assigned to a USER button and the operating mode is set to beat sync, the USER button blinks in time with the current BPM.

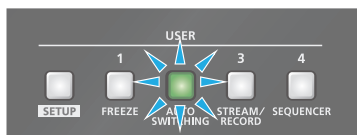

Video follows audio

1. On the setup screen for the auto-switching function, touch <Type> to select “Video Follows Audio”.

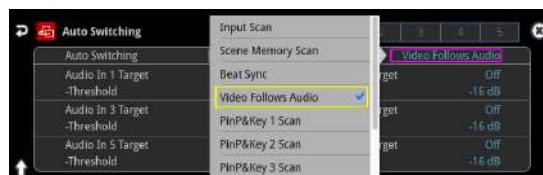

The setup screen changes accordingly.

2. Touch the screen to access the settings.

Menu item	Explanation
Audio In 1-9/10 Target, USB In Target, Bluetooth In Target, Audio Player Target, HDMI 1-6 Target, SDI 1-6 Target, V.Player/SRT In Target	Specifies the video that is output when audio is detected.
Threshold	Specifies the reference level at which the Video Follows Audio function operates. When audio that exceeds this threshold is detected, the video is switched.
Audio Mix Target	Specifies the video that is output when audio is detected in multiple mics. If this is “Off”, video is switched in the order in which audio is detected.
Audio Silent Target	Specifies the video that is output when there is no audio input from any mic. If this is “Off”, the last selected video continues to be output.
Audio Redetection Time	Specifies the time after the video has switched until audio detection resumes.
Scan Transition Time	Specifies the video transition time.

* For details on the parameters, refer to “21: Auto Switching” (p. 152).

3. Press the [SETUP] button to close the screen.

PinP&KEY scan

1. On the setup screen for the auto-switching function, touch <Type> to select “PinP&Key 1–4 Scan”.



The setup screen changes accordingly.

2. Touch the screen to access the settings.

Menu item	Explanation
SCAN SEQUENCE	Specifies the order in which video signals are shown. Normal: Switches in the order of HDMI 1→6, SDI 1→6, STILL 1→16. Reverse: Switches in the order of STILL 16→1, SDI 6→1, HDMI 6→1. Random: Switches randomly.
HDMI 1–8 Time	Specifies the time that the video is shown.
SDI 1–8 Time	Specifies the time that the video is shown.
Still 1–8 Time	Specifies the time that the still image is shown.
V.Player/SRT In Time	Specifies the time that the video is shown.

* For details on the parameters, refer to “21: Auto Switching” (p. 152).

3. Press the [SETUP] button to close the screen.

DSK scan

1. On the setup screen for the auto-switching function, touch <Type> to select “DSK 1, 2 Scan”.



The setup screen changes accordingly.

2. Touch the screen to access the settings.

Menu item	Explanation
SCAN SEQUENCE	Specifies the order in which video signals are shown. Normal: Switches in the order of HDMI 1→6, SDI 1→6, STILL 1→16. Reverse: Switches in the order of STILL 16→1, SDI 6→1, HDMI 6→1. Random: Switches randomly.
HDMI 1–8 Time	Specifies the time that the video is shown.
SDI 1–8 Time	Specifies the time that the video is shown.
Still 1–8 Time	Specifies the time that the still image is shown.
V.Player/SRT In Time	Specifies the time that the video is shown.

* For details on the parameters, refer to “21: Auto Switching” (p. 152).

3. Press the [SETUP] button to close the screen.

Loading a Still Image

You can load a still image, and output it in the same way as video (p. 28) or use it as a source for DSK compositing (p. 40). There are two ways to load a still image: you can load from storage media (either an SD card or a USB flash drive), or you can capture the image from the input video.

You can save up to sixteen still images in the unit.

* When still images are saved in the unit, startup takes longer time according to image size and the number of still images saved.

Loading a Still Image from a Storage

Here's how to load a still image from a storage into the unit.

1. Save the still image in the root directory of the SD card or USB flash drive.
2. Insert the SD card into the SDXC card slot.
* When using a USB flash drive, connect the USB flash drive to the USB HOST port.
3. [MENU] button → "Still Image" → "Load From Storage" → select "Still Image", and press the [VALUE] knob.

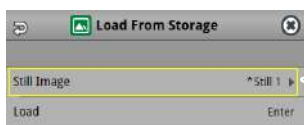

A "*" symbol is displayed for memory where a still image is already saved.

4. Use the [VALUE] knob to select the loading destination for the still image (Still 1–16), and press the [VALUE] knob.
5. Press the [EXIT] button to return to the previous screen.
6. Use the [VALUE] knob to select "Load", and press the [VALUE] knob.

A list of the still images in the storage is shown.



* Use the "SD Card" or "USB Memory" selector at the top right-hand corner of the screen to switch between the storage media to load from.

7. Touch the filename of the still image you want to load.

A confirmation message appears.

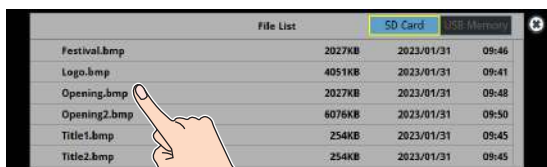

Are you sure you want to load "Opening.bmp"?

Cancel OK

* If you decide to cancel, press the [EXIT] button.

8. Use the [VALUE] knob to select "OK", and press the [VALUE] knob.

The still image is loaded into the unit. When the operation is finished, the message "Completed" appears.

9. Press the [MENU] button to close the menu.

MEMO

You can set the method of saving still images to "temporarily save". When you turn off the power, the loaded still image is deleted.

From the [MENU] button → "Still Image", set "Save To Internal Storage" to "Disable", and then load the still image.

NOTE

- The still image is scaled to the output format size.
- When using a SD card or USB flash drive for the first time, you must format it using the VR-120HD (p. 13).
- Never turn off the power or remove the SD card or USB flash drive while the message "Processing..." is shown.
- Depending on the SD card or USB flash drive, it may take some time to be recognized.

Formats supported for loading

Format	Bitmap file (.bmp), 24-bit color, uncompressed
	PNG file (.png), 24-bit color * Alpha channel supported
	JPEG file (.jpg), 24-bit color
Resolution	In conformity with system format (p. 14)
File name	No more than 64 single-byte alphanumeric characters * The extension ".bmp", ".png", ".jpg", or ".jpeg" must be added.

Capturing a Still Image from Input/Output Video

Here's how to capture a still image from the input/output video.

1. Press the [CAPTURE IMAGE] button to turn on (lit).

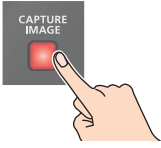

The Capture Image screen appears.

2. Touch the screen to select the save destination memory (Still 1–16) for the still image.

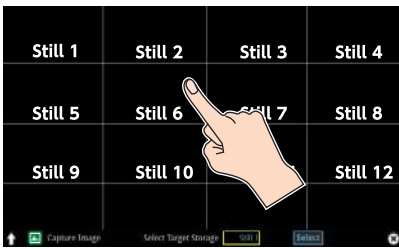

* If you decide to cancel, press the [EXIT] button.

3. Touch <Select> at the bottom of the screen.

The input video screen appears.

4. Touch the screen to select the input video to capture.



* To capture the output video, set the Monitor setting to "Program" (by pressing the [Program] button), or switch to multi-view (by pressing the [Multi-View] button) to select an output video, or use Select Capture Source to select the output video.

5. Touch <Exec> at the bottom of the screen.

The capture is executed. When the operation is finished, the message "Completed" appears.

6. Press the [CAPTURE IMAGE] button to exit the operation.

MEMO

- You can set the method of saving still images to "temporarily save". When you turn off the power, the loaded still image is deleted. From the [MENU] button → "Still Image", set "Save To Internal Storage" to "Disable", and then load the still image.
- If you capture when HDCP (p. 18) is on, the still image that is created is handled in the same way as HDCP-protected video. It cannot be used if HDCP is off.

Outputting a Loaded Still Image

You can assign a still image to the VIDEO SWITCHER [1]–[8] buttons and output it in the same way as with video, or momentarily stop the final output to output the still image.

* When outputting a still image (.png) with an alpha channel, the alpha channel (transparency) data is ignored.

Assigning a Still Image to the VIDEO SWITCHER Buttons

A still image loaded into this unit can be assigned to the VIDEO SWITCHER [1]–[8] buttons, and output in the same way as video.

1. Load a still image into this unit as described by the following procedures.
 - ➔ "Loading a Still Image from a Storage" (p. 27)
 - ➔ "Capturing a Still Image from Input/Output Video" (p. 28)
2. Assign the still image to a VIDEO SWITCHER button by following the steps in "Assigning Video Sources" (p. 16).
3. Follow the steps in "Switching the Video" (p. 20) to output the still image.

Inserting a Still Image in the Final Output

You can pause the final output, and output a still image of your choice as a cut.

Still images can be directly output without being assigned to the VIDEO SWITCHER [1]–[8] buttons.

* The same still image as the final output is also output to the preview.

Use the following methods to output still images.

Using the USER buttons

➔ "Assigning Functions to the USER Buttons" (p. 97)

Using a footswitch

➔ "Using a Footswitch" (p. 101)

Using an expression pedal

➔ "Using an Expression Pedal" (p. 100)

Inputting an external control signal (GPI)

➔ "Inputting a Control Signal" (p. 102)

MEMO

Outputting a still image with a fade-in effect

Use the [OUTPUT FADE] button to add a fade-in effect and output the still image.

Assign a still image to the AUX 1–3 bus (p. 160) and edit the function for the [OUTPUT FADE] button as shown below.

Use the [MENU] button → "System" → and set Output Fade Assign "Video Fade" to "AUX 1–3".

Deleting a Still Image

Here's how to delete the still image that's saved in the unit.

1. [MENU] button → "Still Image" → select "Delete Still Image", and press the [VALUE] knob.

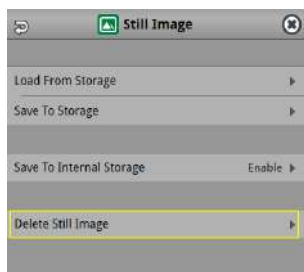

2. Use the [VALUE] knob to select the still image (All, Still 1–16) you want to delete, and press the [VALUE] knob.

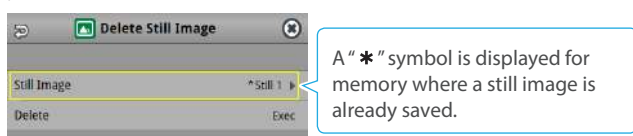

3. Press the [EXIT] button to return to the previous screen.
4. Select "Delete" and press the [VALUE] knob.

A confirmation message appears.

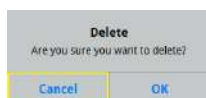

* If you decide to cancel, press the [EXIT] button.

5. Use the [VALUE] knob to select "OK", and press the [VALUE] knob.
The still image is deleted. When the operation is finished, the message "Completed" appears.
6. Press the [MENU] button to close the menu.

Saving a Still Image to a SD Card or USB Flash Drive

Here's how a still image captured from the input/output video (p. 28) can be saved to a storage (SD card or USB flash drive).

- * The still image is saved to the "Roland/VR-120HD/still" folder.
- * You can't export still images that were created while HDCP (p. 18) was set to "ON".

NOTE

- When using a SD card or USB flash drive for the first time, you must format it using the VR-120HD (p. 13).
- Never turn off the power or remove the SD card or USB flash drive while the message "Processing..." is shown.
- Depending on the SD card or USB flash drive, it may take some time to be recognized.

1. Insert the SD card into the SDXC card slot.

* When using a USB flash drive, connect the USB flash drive to the USB HOST port.

2. [MENU] button → "Still Image" → "Save To Storage" → select "Still Image", and press the [VALUE] knob.

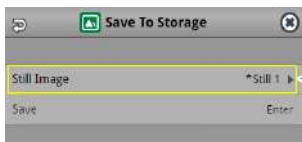

A "*" symbol is displayed for memory where a still image is already saved.

MEMO

"(HDCP)" is indicated for still images that were created when HDCP was on.

3. Use the [VALUE] knob to select the still image (Still 1–16) you want to save, and press the [VALUE] knob.
4. Press the [EXIT] button to return to the previous screen.
5. Use the [VALUE] knob to select "Save", and press the [VALUE] knob.

The still images on the storage media (in the "Still" folder) are shown as a list.

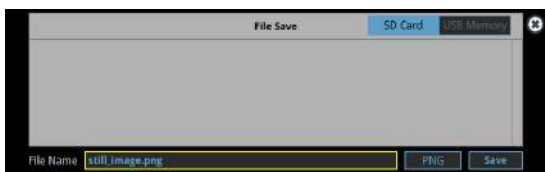

* Use the "SD Card" or "USB Memory" selector at the top right-hand corner of the screen to switch between the storage media to save.

7. Select "File Name" and press the [VALUE] knob.

This brings up the software keyboard for input.

8. Enter a file name.

* You can input up to 32 characters.

9. Touch <Enter> in software keyboard.



10. Select the file type

- ① Use the [VALUE] knob to select "File Type", and press the [VALUE] knob.
- ② Use the [VALUE] knob to select "BITMAP", "PNG", or "JPEG", and press the [VALUE] knob.

11. Use the [VALUE] knob to select "Save", and press the [VALUE] knob.

A confirmation message appears.

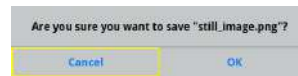

* If you decide to cancel, press the [EXIT] button.

12. Use the [VALUE] knob to select "OK", and press the [VALUE] knob.

The still image is written to the storage.

13. Press the [MENU] button to close the menu.

MEMO

Overwriting a still image

When you touch a filename for an existing still image on the screen in step 5, the filename in the filename list is used. You can overwrite the name.

Importing a Video

Here's how to load a video from your storage media into this unit. You can play back the videos that you've loaded, and output them in the same way as with regular video signals.

1. Save the video in the root directory of the SD card or USB flash drive.
2. Insert the SD card into the SDXC card slot.
 - * When using a USB flash drive, connect the USB flash drive to the USB HOST port.
3. [MENU] button → "Video Player" → select "Import", and press the [VALUE] knob.

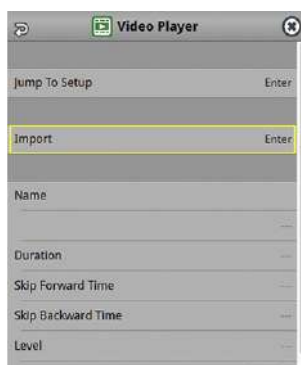

A list of the videos in the storage is shown.



- * Use the "SD Card" or "USB Memory" selector at the top right-hand corner of the screen to switch between the storage media to load from.
 - * Select "Root" or "Rec" in the upper left part of the screen to switch between folders from which the files are loaded.
4. Touch the filename of the video you want to load.

A confirmation message appears.

 - * Touch the preview icon (▶) to play back the video.

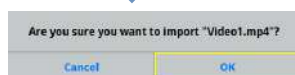
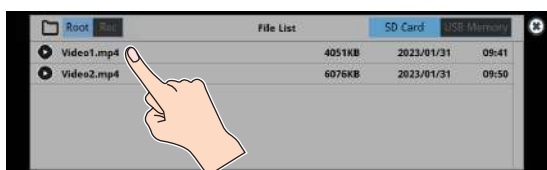

- * If you decide to cancel, press the [EXIT] button.
5. Use the [VALUE] knob to select "OK", and press the [VALUE] knob.

The video is imported into the unit. When the operation is finished, the message "Completed" appears.
 6. Press the [MENU] button to close the menu.

NOTE

- The video is scaled to the output format size.
- When using a SD card or USB flash drive for the first time, you must format it using the VR-120HD (p. 13).
- Never turn off the power or remove the SD card or USB flash drive while the message "Processing..." is shown.
- Depending on the SD card or USB flash drive, it may take some time to be recognized.

Formats supported for importing

Format	MP4 File (.mp4), H.264, AAC (48 kHz), Average bit rate of 20 Mbps or less
Resolution	Maximum 1920 x 1080 pixels
File name	Maximum of 64 single-byte alphanumeric characters, including the file extension

* Videos can only be imported from storage media. These videos are not saved to this unit.

Outputting a Loaded Video

You can assign videos to the VIDEO SWITCHER [1]–[8] buttons and output them in the same way as with video, or momentarily stop the final output to output the video.

Playing Back a Video (with the Video Player)

Use the video player to play back the videos you've loaded.

Assigning a USER button

To use the video player, you must assign the video player function to the USER buttons. This lets you play back/stop video using the assigned buttons, and operate the video from the setup screen.

The video player function is not assigned to the USER buttons by factory default.

1. Assign the "Video Player" function to a USER button by following the steps in "Assigning Functions to the USER Buttons" (p. 97).

Set "Category" to "Video Player", and set "Value" to "Setup".

Video player settings

2. Press the USER [SETUP] button.
The User Assign screen appears.
3. Touch <Setup> for the USER button to which you assigned the video player function.

The Video Player setup screen appears.

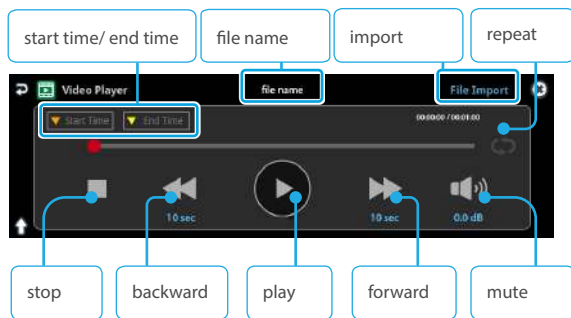

4. Touch the screen to configure the video player.

Menu item	Explanation
File Import	Loads the video.
File Name	Shows the filename of the video that was loaded.
Start Time	Sets the playback start point of the video.
End Time	Sets the playback end point of the video.
Skip Forward Time	Sets how much the video fast-forwards (the amount of time) when you touch <▶▶>.
Skip Backward Time	Sets how much the video fast-forwards (the amount of time) when you touch <◀◀>.
Level	Adjusts the playback volume of the video.
Repeat	Switches repeat playback on/off.

5. Touch <▶>.

The video plays back according to the settings.

MEMO

You can also access the setup screen by pressing the [MENU] button and then pressing "Video Player" → "Jump to Setup".

Assigning Videos to the VIDEO SWITCHER Buttons

Here's how to assign a still image loaded into this unit to the VIDEO SWITCHER [1]–[8] buttons, and output the image in the same way as video.

1. Follow the steps in "Importing a Video" (p. 31) to load the video into this unit.
2. Assign the video to a VIDEO SWITCHER button by following the steps in "Assigning Video Sources" (p. 15).
3. Follow the steps in "Switching the Video" (p. 20) to output the video.

MEMO

You can also directly touch the Multi-View, Input-View or Still-View screens to select a video signal.

Inserting a Video in the Final Output

You can pause the final output, and output a video of your choice as a cut. Video can be directly output without being assigned to the VIDEO SWITCHER [1]–[8] buttons.

* The same video as the final output is also output to the preview.

Use the following methods to output video.

Using the USER buttons

⇒ "Assigning Functions to the USER Buttons" (p. 97)

Using a footswitch

⇒ "Using a Footswitch" (p. 101)

Using an expression pedal

⇒ "Using an Expression Pedal" (p. 100)

Inputting an external control signal (GPI)

⇒ "Inputting a Control Signal" (p. 102)

NOTE

- If either the streaming and recording format or the file played by the video player exceeds 1080/30p, the streaming and recording and video player functions cannot be used simultaneously.
- If the bitrate setting for Streaming and Recording and the bitrate of the file played on Video Player exceeds 20,000 kbps, Streaming and Recording and Video player cannot be used simultaneously.

Inputting SRT Video

SRT video input is supported on the VR-120HD. SRT video signals that are sent over a network can be input into the VR-120HD and treated as video content.

This section describes how to make the necessary connections and input the SRT content, using an SRT video output device connected to your LAN as an example.

* You can't use the video player (p. 32) when SRT video is being input.

Network Requirements



* To input video over a network, the IP address, subnet mask and default gateway must be configured.

These settings are usually retrieved from the DHCP server and assigned.

Assigning the SRT Input Video Channel to the VIDEO SWITCHER [1]–[8] Buttons

To input SRT video, you must assign the SRT video channel to one of the VIDEO SWITCHER [1]–[8] buttons.

1. Press the [MENU] button → "Video Player/SRT In" → select "Type" and press the [VALUE] knob.

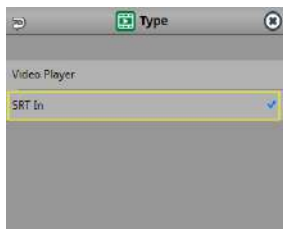

2. Select "SRT In" and press the [VALUE] knob.
3. Press the [MENU] button → "Video Assign" → select "Input 1–8" and press the [VALUE] knob.



4. Use the [VALUE] knob to select "SRT In", and press the [VALUE] knob.

This assigns the SRT video input to the selected VIDEO SWITCHER [1]–[8] button.

Connecting an SRT-compatible Device to Input SRT Video

The SRT video signal can be connected from either the transmitting or receiving device, regardless of the orientation of the video signal.

The device that's waiting for the connection is in "listener" mode, and the device that's initiating the connection is in "caller" mode. Depending on the device, one or both modes are supported.

The VR-120HD supports both listener and caller modes.

Connecting in caller mode

In caller mode, configure the receiving device (VR-120HD) to match the configuration of the transmitting device.

Here's how to make an SRT connection from the VR-120HD to the transmitting device and input the video to the VR-120HD.

1. Set the SRT mode of the transmitting device to listener mode, and input the other settings.

* For details on how to connect and operate in this mode, refer to the owner's manual of the transmitting device.

2. Press the [MENU] button → "Video Player/SRT In" → select "Type" and press the [VALUE] knob.

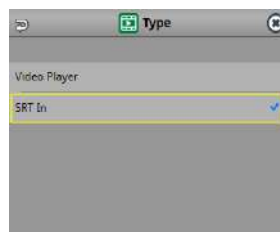

3. Select "SRT In" and press the [VALUE] knob.
4. Press the [EXIT] button to return to the previous screen.
5. Use the [VALUE] knob to select "SRT In Setup", and press the [VALUE] knob.
6. Use the [VALUE] knob to select "Mode", and then press the [VALUE] knob.

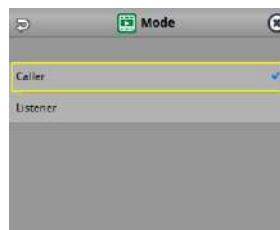

7. Select "Caller" and press the [VALUE] knob.
8. Press the [EXIT] button to return to the previous screen.

9. Use the [VALUE] knob to change the setting as shown below.

Parameter	Explanation
Capacity	Sets the maximum bit rate at which a video signal can be received.
Remote IP Address	Sets the IP address of the SRT transmitting device.
Remote Port	Sets the port number of the SRT transmitting device.
Latency	Sets the length (delay time) of the SRT retransmission buffer. Out of the latencies set for the receiving and transmitting devices, the one with the larger value takes precedence. Set this as necessary.
Stream ID	If a stream ID is set for the transmitting device, set the stream ID to this same ID. * If the stream IDs on the sending and receiving devices do not match, the video cannot be transmitted or received.
Passphrase	If encryption is set on the transmitting device, set the to the same passphrase as the one used on the transmitting device. * If the passphrases of the transmitting and receiving devices don't match, the video cannot be transmitted or received.

MEMO

You can also configure this using the Web app.
The VR-120HD must be connected to the Internet before you use the Web app.

- Use the [VALUE] knob to select "Use Web Application", and press the [VALUE] knob.
A QR code (URL) appears on the this unit's display.
- Open the displayed URL on your computer or smartphone.
- Configure the parameters on your computer or smartphone, and press the [SUBMIT] button.
The settings are applied to the VR-120HD.

- Press the [EXIT] button to return to the previous screen.
- Set the transmitting device to SRT listener mode.
- Use the [VALUE] knob to select "Start/Stop", and press the [VALUE] knob.
The message "Are you sure you want to start SRT Input?" appears.
- Select "OK" and press the [VALUE] knob.
The video from the transmitting device is shown in the multi-view.

Connecting in listener mode

This shows how to configure the VR-120HD in listener mode to listen for SRT connections.

This connects the transmitting device to the VR-120HD via SRT and input the video to the VR-120HD.

- Press the [MENU] button → "Video Player/SRT In" → select "Type" and press the [VALUE] knob.

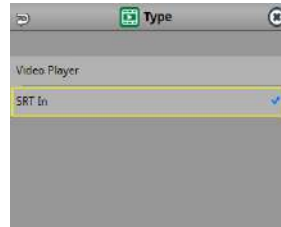

- Select "SRT In" and press the [VALUE] knob.
- Press the [EXIT] button to return to the previous screen.
- Use the [VALUE] knob to select "SRT In Setup", and press the [VALUE] knob.
- Use the [VALUE] knob to select "Mode", and then press the [VALUE] knob.

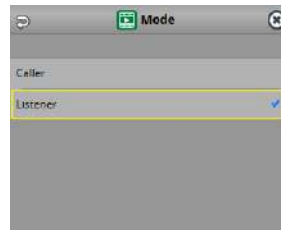

- Select "Listener" and press the [VALUE] knob.
- Press the [EXIT] button to return to the previous screen.
- Use the [VALUE] knob to change the setting as shown below.

Parameter	Explanation
Local Port	Sets the port number of the SRT transmitting device.
Latency	Sets the length (delay time) of the SRT retransmission buffer. Out of the latencies set for the receiving and transmitting devices, the one with the larger value takes precedence. Set this as necessary.
Passphrase	If encryption is set on the transmitting device, set the to the same passphrase as the one used on the transmitting device. * If the passphrases of the transmitting and receiving devices don't match, the video cannot be transmitted or received.

* In listener mode, you do not need to set the Stream ID.

MEMO

You can also configure this using the Web app.

The VR-120HD must be connected to the Internet before you use the Web app.

1. Use the [VALUE] knob to select "Use Web Application", and press the [VALUE] knob.
A QR code (URL) appears on the this unit's display.
2. Open the displayed URL on your computer or smartphone.
3. Configure the parameters on your computer or smartphone, and press the [SUBMIT] button.
The settings are applied to the VR-120HD.

9. Press the [EXIT] button to return to the previous screen.
10. Set the SRT mode of the transmitting device to caller mode.
* For details on how to connect and operate in this mode, refer to the owner's manual of the transmitting device.
11. Set the caller mode of the transmitting device based on the settings in step 8.
* Press the [MENU] button → "Network" → "Network Information" to check the IP address that's set for the transmitting device.
12. Use the [VALUE] knob to select "Start/Stop", and press the [VALUE] knob.
The message "Are you sure you want to start SRT Input?" appears.
13. Select "OK" and press the [VALUE] knob.
The unit enters SRT listening mode.
14. Perform the operations for connecting on the transmitting device.
The video from the transmitting device is shown in the multi-view.

Stopping the SRT connection

The SRT connection can be stopped from either the transmitting or receiving device.

Follow the steps on the VR-120HD as shown below to stop the connection.

1. Press the [MENU] button → "Video Player/SRT In" → select "Start/Stop", and press the [VALUE] knob.
The message "Are you sure you want to stop SRT input?" appears.
2. Select "OK" and press the [VALUE] knob.
* To stop the connection from the transmitting device, refer to the owner's manual of that device.

Fading-In/Out the Final Output Video

Here's how to perform a fade-out from the final output video to a black screen, or a fade-in from a black screen to the final output video.

A scene that you don't want to output as video can be changed to a black screen.

- * The final output video and audio fades in/out together when using the factory default settings.
- * The fade-in/out effect is applied only to the final output.

1. Press the [OUTPUT FADE] button.

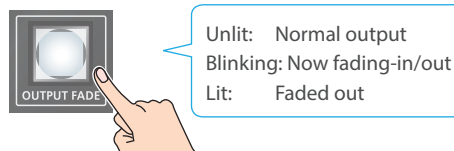

The final output video fades-out to a black screen.

When fade-out is complete, the [OUTPUT FADE] button is lit.

2. To fade-in, press the [OUTPUT FADE] button once again.

The [OUTPUT FADE] button blinks, and final output begins.

When fade-in is complete, the [OUTPUT FADE] button goes dark.

MEMO

- You can use a white screen or the video from the AUX bus to add a fade-in/out effect.
To make this setting, use the [MENU] button → "System" → Output Fade Assign "Video Fade".
- To create a fade-in/out effect for the video without changing the volume, set "Audio Fade" in "Output Fade Assign" from the [MENU] button → "System" to "OFF".
- To specify fade-in/out time, use the [MENU] button → "System" → Output Fade Assign "Time".

Freezing the Input Video (Freeze)

Here's how to temporarily freeze the input video (freeze function).
You can apply transition effects during a video freeze.

MEMO

You can assign the freeze function to a USER button to turn the video on/off ("Assigning Functions to the USER Buttons" (p. 97)).
The freeze function is assigned to the USER [1] button by factory default.

Setting the Operation Mode

There are two freeze modes: the "All mode" for freezing all input video, and the "Select mode" that freezes only the input video you specify. Set the mode that matches your needs.

1. Press the USER [SETUP] button.

The User Assign screen appears.

2. Touch User 1 <Setup>.

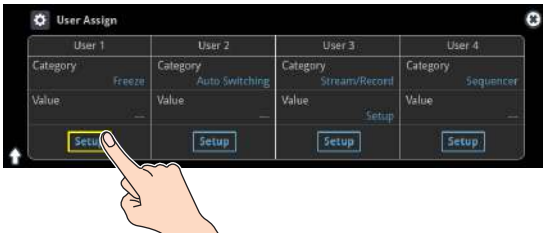

The Freeze function setup screen appears.

3. Touch <Type> to select the operating mode.

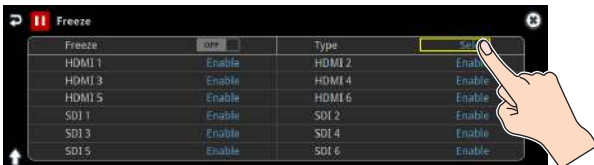

Value	Explanation
All	Freezes all video that is being input.
Select	Freezes only the specified input video.

If "Select" is selected

4. Touch the screen to specify a source from "HDMI 1" to "SDI 6".

Value	Explanation
Enable	The input video freezes.
Disable	The input video does not freeze.

5. Press the [SETUP] button to close the screen.

Freezing the Input Video

1. Press the USER [1] (FREEZE) button to turn freeze on (the button lights up).

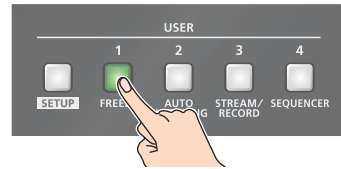

The input video freezes.

2. To turn freeze off, press the USER [1] (FREEZE) button again.

Video Composition Operations

Compositing Video with Picture-in-Picture (PinP)

Here's how to composite an inset screen onto the background video. You can use PinP & Key 1–4 at the same time to display four inset screens. This example shows you how to composite video using "PinP & Key 1". The operation is the same when using "PinP & Key 2–4".

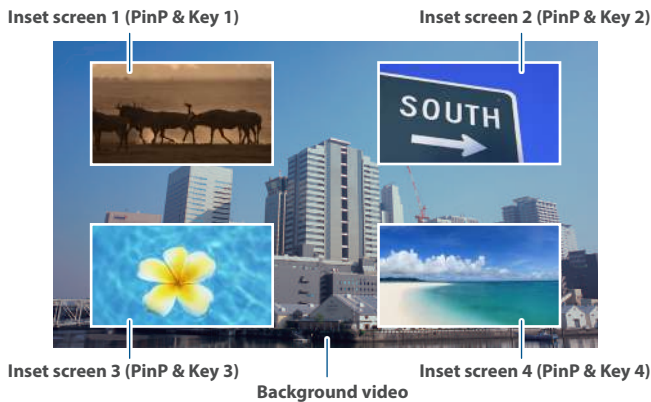

1. Press the PinP & Key 1 [SETUP] button to turn it on (the button lights up).

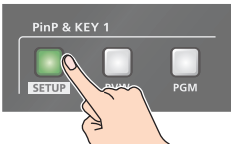

The PinP & Key setup screen appears.

Yellow guide lines for the inset screens (PinP & Key 1) are shown in the multi-view.

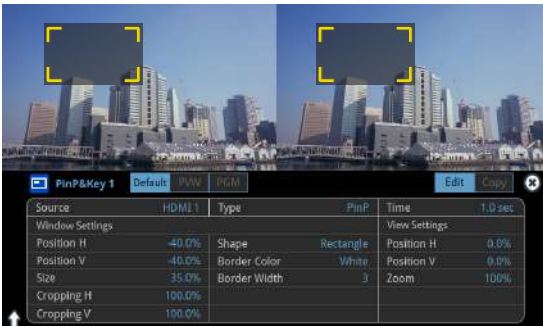

2. Press a VIDEO SWITCHER [1]–[8] button to select the video you want to make the inset screen.

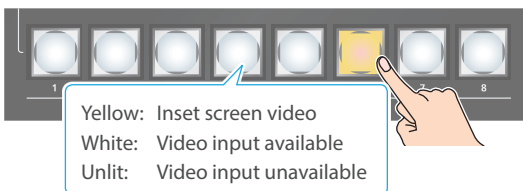

* When selecting a video that is not assigned to Input 1–8, set this in "Source" on the setup screen.

MEMO

You can also directly touch the multi-view, input-view or still-view screens to select a video signal.

3. Press the PinP & KEY 1 [PVW] button to turn on the inset screen preview output (lit).

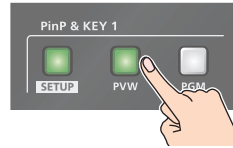

The inset screen appears in the PVW section of the multi-view, allowing you to check the inset screen's location and size.

At this stage, the final output has not yet been changed.

4. Touch the setup screen to adjust the position of the inset screen.

Window Settings	Explanation
Position H	Adjusts the horizontal position of the inset screen.
Position V	Adjusts the vertical position of the inset screen.
Size	Adjusts the size of the inset screen.

MEMO

Making adjustments by touching the inset screen

You can directly drag on an inset screen to adjust its position, and you can pinch in/out to adjust its size.



5. Press the PinP & KEY 1 [PGM] button to turn on PinP compositing (lit).

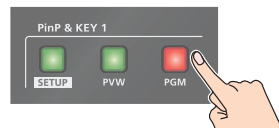

The inset screen is displayed on the final output.

6. To turn off PinP compositing, press the PinP & KEY 1 [PGM] button once again.

Turning PinP/DSK composition on/off in tandem with video transitions

You can make PinP/DSK composition turn on/off in tandem with the video transitions.

From the [MENU] button → “System”, set “Effects Transition Sync” to “ON”. After step 4, use the [AUTO] and [CUT] buttons to switch the video. PinP composition turns on, and the composited result that is previewed is sent to final output.

MEMO

- The output video layers are structured as shown in the illustration below.

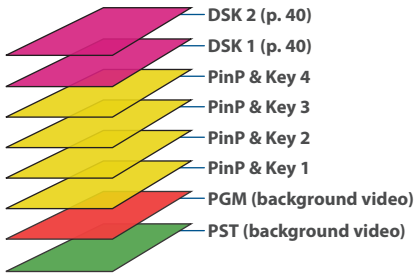

- Long-pressing the [PVW] or [PGM] button for each layer shows only the layer that is targeted for the operation while the button is pressed (this is the spot function: from the [MENU] button → “System”, set “Effects Spot” to “ON”).
- Set the fade-in/out time for the inset screen from the “Time” parameter on the PinP&Key setup screen.

Making Detailed Settings for the Inset Screen

You can configure the detailed inset screen settings including size, shape, border width and more from the PinP setup screen.



Parameter	Explanation
Source	Specifies the video source of the inset screen.
Type	Specifies the type of PinP compositing.
Time	Specifies the video transition time.
Window Settings	Adjusts the inset screen.
Position H	Adjusts the horizontal position.
Position V	Adjusts the vertical position.
Size	Adjusts the size (enlarge or reduce).
Cropping H	Adjusts the horizontal size.
Cropping V	Adjusts the vertical size.
Shape	Specifies the shape (rectangle, circle, diamond).
Border Color	Specifies the color of the border.
Border Width	Adjusts the width of the border.
View Settings	Adjusts the video that is shown in the inset screen.
Position H	Adjusts the horizontal position.
Position V	Adjusts the vertical position.
Zoom	Adjusts the zoom of the video.

* For details on the parameters, refer to “5: PinP & Key” (p. 113).

Swapping and copying settings

You can change the stacking order of the inset screens and copy the settings from other PinP & Key layers by swapping (exchanging) settings with the other PinP & Key layers.

1. Touch the page tab at the top right-hand corner of the PinP setup screen and select “Copy”.



2. Touch the screen to access the settings.

Value	Explanation
Copy From PinP & Key 1–4	Lets you copy other PinP & Key layer settings.
Swap With PinP & Key 1–4	Swaps settings with another PinP & Key layer.

Key Compositing the Inset Screen

This process makes part of the inset screen transparent, and composites the image with the background video.

You can use luminance key with either a black or a white background, or a chroma key with either a blue or green background.

Luminance key

You can cut out text or an image by turning its black or white portion transparent, and then superimpose it on the background video.

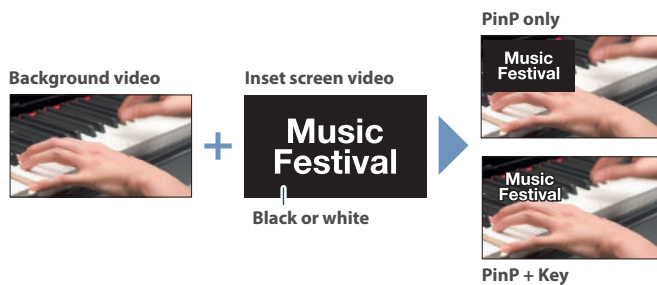

Chroma key

You can cut out a video by turning its blue or green portion transparent, and then superimpose it on the background video.

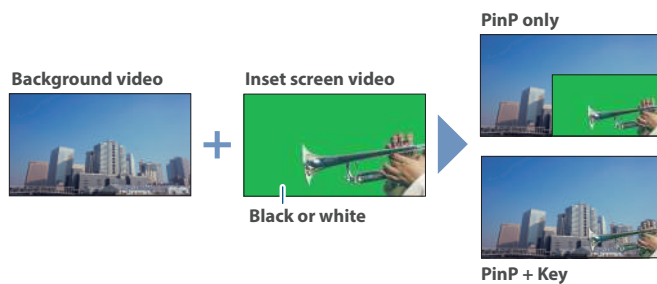

1. On the PinP setup screen, touch “Type” to select the PinP composition type.

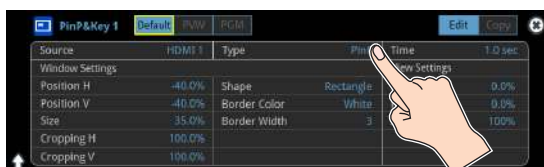

Value	Explanation
Luminance-White Key	A combination of PinP and luminance key (white). Makes the white portions of the inset screen transparent, and composites the image with the background.
Luminance-Black Key	A combination of PinP and luminance key (black). Makes the black portions of the inset screen transparent, and composites the image with the background.
Chroma Key	A combination of PinP and chroma key. Makes the specified key color portions of the inset screen transparent, and composites the image with the background.

* For details on the parameters, refer to “5: PinP & Key” (p. 113).

2. Adjust the intensity of the effect according to the selected type.

Compositing Video with Downstream Keyer (DSK)

You can further composite titles, subtitles/captions and other video on video composited using split (p. 22) or PinP (p. 37). There are two DSK series on the VR-120HD. DSK layers are shown in front of other layers (➡ memo on p. 37).

About DSK Mode

There are three DSK composition modes, "Self key", "Alpha key" and "External key". The following video compositing is available according to the DSK mode.

Self key

Luminance key (p. 41)

You can cut out text or an image by turning its black or white portion transparent, and then superimpose it on the background video.



Chroma key (p. 42)

You can cut out a video by turning its blue or green portion transparent, and then superimpose it on the background video. You can select a color from the video material to set as the key color.



Alpha key (p. 44)

Use alpha channels (areas which contain transparency data) to cut out still images and place them against different background video as a composite.



External key (p. 45)

Sets the key signal (the shape to be cut out) and the fill video (the video to be composited) separately. This uses the key signal to cut out the fill video and superimpose it on the background video to create the composite.

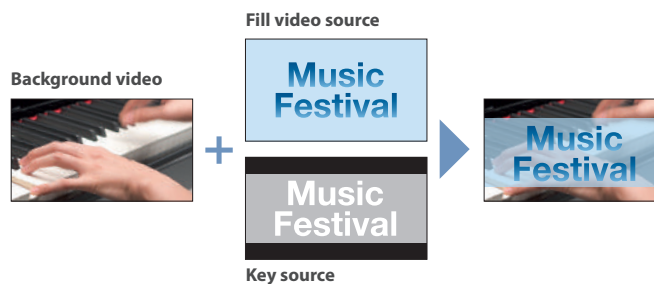

Compositing a Caption or Image (Luminance Key)

Here's how you can cut out text or image by turning its black or white portion transparent, and then superimpose it on the background video.



Compositing using DSK

This shows how to composite an image using "DSK 1". The steps are the same when using "DSK 2".

1. Press the DSK 1 [SETUP] button to turn on (lit).



The DSK setup screen appears.



2. Touch the setup screen to make the following settings.

Parameter	Explanation
DSK Mode	Self Key
DSK Type	Luminance-White Key (Makes white portions transparent according to brightness.)
	Luminance-Black Key (Makes black portions transparent according to brightness.)

3. Press a VIDEO SWITCHER [1]–[8] button to select the DSK video source.

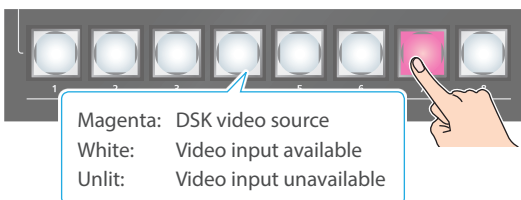

* When selecting a video that is not assigned to Input 1–8, set this in "DSK Source" on the setup screen.

MEMO

You can also directly touch the multi-view, input-view or still-view screens to select a video signal.

4. Press the DSK 1 [PVW] button to turn on the preview output (lit).

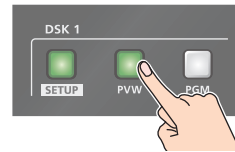

A preview of the composition results is displayed in the PVW section of the multi-view.

At this stage, the final output has not yet been changed.

5. Touch the setup screen to adjust the intensity of the effect.

Parameter	Explanation
DSK Settings	
DSK Level	Adjusts the degree of extraction (transparency) for the key.
DSK Gain	Adjusts the degree of edge blur (semi-transmissive region) for the key.
Time	Adjusts the fade-in/out time for the DSK video source.

* For details on the parameters, refer to "6: DSK" (p. 115).

6. Press the DSK 1 [PGM] button to turn on DSK compositing (lit).

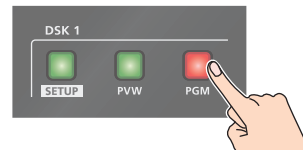

The composition results is sent to final output.

7. To turn off DSK compositing, press the DSK 1 [PGM] button once again.

Turning DSK/PinP composition on/off in tandem with video transitions

You can make DSK/PinP composition turn on/off in tandem with the video transitions.

From the [MENU] button → "System", set "Effects Transition Sync" to "ON". After step 4, use the [AUTO] and [CUT] buttons to switch the video. DSK composition turns on, and the composited result that is previewed is sent to final output.

Modifying the caption or image

You can fill-in the superimposed caption or image, or add an edge to it. Configure the following parameters on the DSK setup screen.

Parameter	Explanation
Fill Settings	
Fill Type	If this is set to "Matte", the superimposed caption or video is filled in with the color specified in "Matte Color".
Matte Color	
Edge Settings	
Edge Type	Specifies the type of edge.
Edge Color	Specifies the color of the edge.
Edge Width	Specifies the width of the edge.

* This setting is in common with chroma key ("Compositing a Subject and Background (Chroma Key)" (p. 42)).

Compositing a Subject and Background (Chroma Key)

Here's how you can cut out a video by turning its blue or green portion transparent, and then superimpose it on the background video. This lets you composite a subject that's photographed against a blue background or green background.



Compositing using DSK

This shows how to composite an image using "DSK 1". The steps are the same when using "DSK 2".

1. Press the DSK 1 [SETUP] button to turn on (lit).

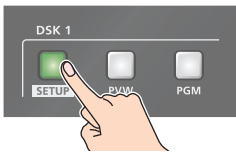

The DSK setup screen appears.

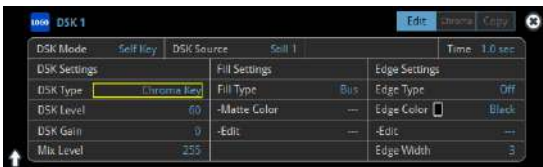

2. Touch the setup screen to make the following settings.

Parameter	Explanation
DSK Mode	Self Key
DSK Type	Chroma Key
Chroma Settings (page 2)	
Color	Specify either "GREEN" or "BLUE" as the key color. You can also specify a color you desire as the key color (p. 43).

3. Press a VIDEO SWITCHER [1]–[8] button to select the DSK video source.

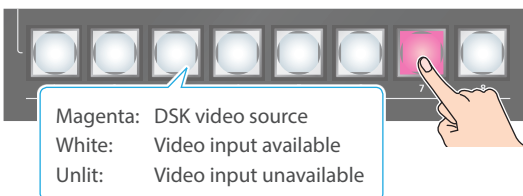

* When selecting a video that is not assigned to Input 1–8, set this in "DSK Source" on the setup screen.

MEMO

You can also directly touch the multi-view, input-view or still-view screens to select a video signal.

4. Press the DSK 1 [PVW] button to turn on the preview output (lit).

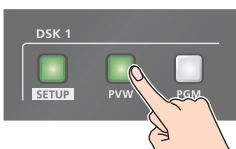

A preview of the composition results is displayed in the PVW section of the multi-view.

At this stage, the final output has not yet been changed.

5. Touch the setup screen to adjust the intensity of the effect.

Parameter	Explanation
DSK Settings	
DSK Level	Adjusts the degree of extraction (transparency) for the key.
DSK Gain	Adjusts the degree of edge blur (semi-transmissive region) for the key.
Time	Adjusts the fade-in/out time for the DSK video source.

* For details on the parameters, refer to "6: DSK" (p. 115).

6. Press the DSK 1 [PGM] button to turn on DSK compositing (lit).

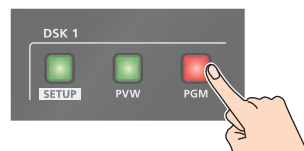

The composition results is sent to final output.

7. To turn off DSK compositing, press the DSK 1 [PGM] button once again.

Turning DSK/PinP composition on/off in tandem with video transitions

You can make DSK/PinP composition turn on/off in tandem with the video transitions.

From the [MENU] button → "System", set "Effects Transition Sync" to "ON". After step 4, use the [AUTO] and [CUT] buttons to switch the video. DSK composition turns on, and the composited result that is previewed is sent to final output.

Finely adjusting the key color

You can make fine adjustments to the key color.
Configure the following parameters on the DSK setup screen.

Parameter	Explanation
Chroma Settings (page 2)	
Hue Width	Adjusts the hue width.
Hue Fine	Adjusts the center position of the hue.
Saturation Width	Adjusts the saturation width.
Saturation Fine	Adjusts the center position of saturation.
Value Width	Adjusts the brightness width.
Value Fine	Adjusts the center position of the brightness.
Despill	Sets the spill removal (despill).

* For details on the parameters, refer to “6: DSK” (p. 115).

Modifying the superimposed video

You can fill-in the superimposed video, or add an edge to it.
Configure the following parameters on the DSK setup screen.

Parameter	Explanation
Fill Settings	
Fill Type	If this is set to “Matte”, the superimposed video is filled in with the color specified in “Matte Color”.
Matte Color	
Edge Settings	
Edge Type	Specifies the type of edge.
Edge Color	Specifies the color of the edge.
Edge Width	Specifies the width of the edge.

* This setting is in common with luminance key (“Compositing a Caption or Image (Luminance Key)” (p. 41)).

Specifying a desired color as the key color (sampling marker)

You can specify the key color to be made transparent by sampling (detecting) a color from the video (sampling marker function).
You can also specify a key color other than green or blue.

1. Touch <Sampling Marker Mode> on page 2 of the setup screen.



The sampling marker (⊕) used to sample (detect) the key color is shown on the monitor of this unit.



2. Touch the screen to adjust the sampling marker position.

The sampling marker moves to the position you touch.

Menu item	Explanation
Position H	Adjusts the horizontal position.
Position V	Adjusts the vertical position.

3. Touch <Exec> on the screen.

A confirmation message appears.

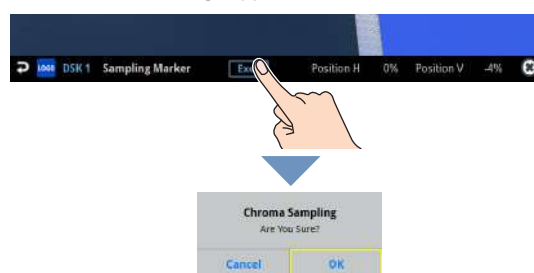

* If you decide to cancel, press the [EXIT] button.

4. Use the [VALUE] knob to select “OK”, and press the [VALUE] knob.

The key color is sampled.

The “Hue Width”, “Hue Fine”, “Saturation Width”, and “Saturation Fine” settings are adjusted automatically.

Compositing a Still Image with Alpha Channel

Use alpha channels (areas which contain transparency data) to cut out still images and place them against different background video as a composite.



Compositing using DSK

This shows how to composite an image using "DSK 1". The steps are the same when using "DSK 2".

1. Press the DSK 1 [SETUP] button to turn on (lit).



The DSK setup screen appears.



2. Touch the setup screen to make the following settings.

Parameter	Explanation
DSK Mode	Alpha Key
DSK Source	Specifies the still image with alpha channel.

3. Press a VIDEO SWITCHER [1]–[8] button to select the DSK video source.

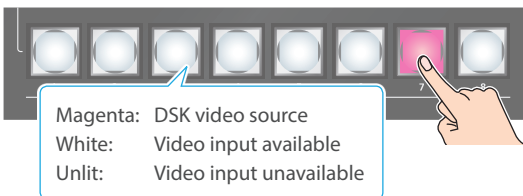

* When selecting a video that is not assigned to Input 1–8, set this in "DSK Source" on the setup screen.

MEMO

You can also directly touch the multi-view, input-view or still-view screens to select a video signal.

4. Press the DSK 1 [PVW] button to turn on the preview output (lit).

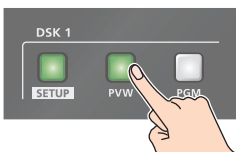

A preview of the composition results is displayed in the PVW section of the multi-view.

At this stage, the final output has not yet been changed.

5. Touch the setup screen to adjust the intensity of the effect.

Parameter	Explanation
Mix Level	Adjusts the key's overall density (output level).
Time	Adjusts the fade-in/out time for the DSK video source.

* For details on the parameters, refer to "6: DSK" (p. 115).

6. Press the DSK 1 [PGM] button to turn on DSK compositing (lit).

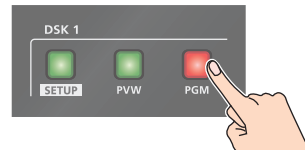

The composition results is sent to final output.

7. To turn off DSK compositing, press the DSK 1 [PGM] button once again.

Turning DSK/PinP composition on/off in tandem with video transitions

You can make DSK/PinP composition turn on/off in tandem with the video transitions.

From the [MENU] button → "System", set "Effects Transition Sync" to "ON". After step 4, use the [AUTO] and [CUT] buttons to switch the video. DSK composition turns on, and the composited result that is previewed is sent to final output.

Using an External Key

This sets the key signal (the shape to be cut out) and the fill video (the video to be composited) separately. With an external key, the key signal is used to cut out the fill video and superimpose it on the background video to create the composite.

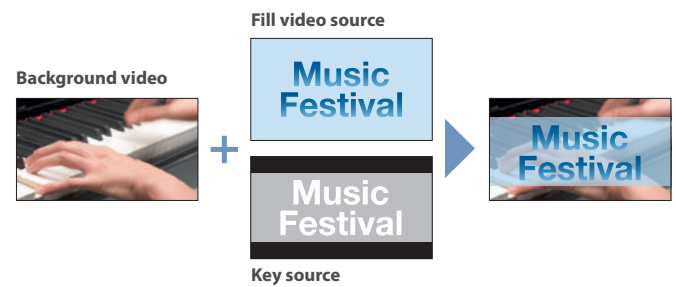

Compositing using DSK

This shows how to composite an image using "DSK 1". The steps are the same when using "DSK 2".

1. Press the DSK 1 [SETUP] button to turn on (lit).

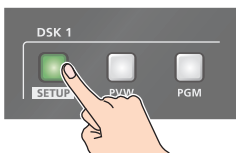

The DSK setup screen appears.



2. Touch the setup screen to make the following settings.

Parameter	Explanation
DSK Mode	External Key
Key Source	Specifies the video to use as the key signal.
Fill Source	Specifies the fill video source.

3. Press a VIDEO SWITCHER [1]–[8] button to select the fill source.

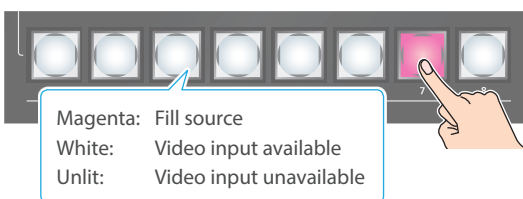

* When selecting a video that is not assigned to Input 1–8, set this in "Fill Source" on the setup screen.

MEMO

You can also directly touch the multi-view, input-view or still-view screens to select a video signal.

4. Press the DSK 1 [PVW] button to turn on the preview output (lit).

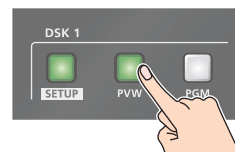

A preview of the composition results is displayed in the PVW section of the multi-view.

At this stage, the final output has not yet been changed.

5. Touch the setup screen to adjust the intensity of the effect.

Parameter	Explanation
Mix Level	Adjusts the key's overall density (output level).
Time	Adjusts the fade-in/out time for the DSK video source.

* For details on the parameters, refer to "6: DSK" (p. 115).

6. Press the DSK 1 [PGM] button to turn on DSK compositing (lit).

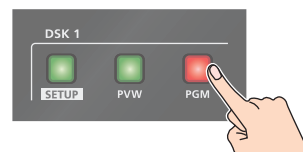

The composition results is sent to final output.

7. To turn off DSK compositing, press the DSK 1 [PGM] button once again.

Turning DSK/PinP composition on/off in tandem with video transitions

You can make DSK/PinP composition turn on/off in tandem with the video transitions.

From the [MENU] button → "System", set "Effects Transition Sync" to "ON". After step 4, use the [AUTO] and [CUT] buttons to switch the video. DSK composition turns on, and the composited result that is previewed is sent to final output.

Compositing Content from Graphics Presenter (Roland Fill+Key mode)

You can use the dedicated Roland Graphics Presenter app to input and composite content (titles, images and videos) from your computer to the VR-120HD using a single HDMI cable. No adjustments are required on this unit for key compositing.

Roland Graphics Presenter (hereafter “Graphics Presenter”) is available for download from the Roland website.

<https://proav.roland.com/>

- * Graphics Presenter is a dedicated application for Windows.
- * For detailed operating instructions, refer to the “Graphics Presenter Owner’s Manual” (Roland website).

Required items

- VR-120HD
- A Windows PC with Graphics Presenter installed
- HDMI cable (1)



Compositing using DSK

Here are the steps for compositing Graphics Presenter content using DSK 1.

The steps are the same when using DSK 2.

Connecting your computer

1. Press the [MENU] button to select “Roland Fill+Key”, and press the [VALUE] knob.

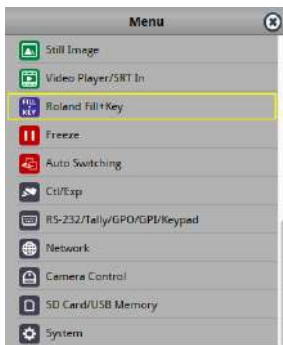

2. Use the [VALUE] knob to select “Mode”, and then press the [VALUE] knob.
3. Select “DSK 1” and press the [VALUE] knob.
Set Roland Fill+Key mode to ON.
4. Press the [VALUE] knob to close the dialog box.
5. Press the [EXIT] button to return to the previous screen.
6. Use an HDMI cable to connect the HDMI connector on your computer to the HDMI IN 6 connector on the VR-120HD.
The video signal from the computer is shown for HDMI In 6 on the VR-120HD.

Compositing using DSK

7. Launch “Graphics Presenter” on your computer.
8. Click on the [ON AIR] button in Graphics Presenter.
The [ON AIR] button lights up red, and a black image is shown for HDMI In 6 on the VR-120HD.
9. Use “Graphics Presenter” to output the content.
The contents outputted from Graphics Presenter are shown for HDMI In 6 on the VR-120HD.
10. Press the DSK 1 [PVW] button or the [PGM] button to turn them on (lit).

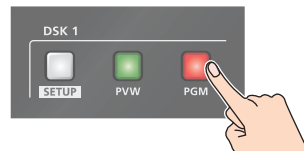

The Graphics Presenter content is composited into the preview or final output from the VR-120HD.

Turning Roland Fill+Key mode OFF

When you turn off Roland Fill+Key mode, be sure to do so as follows.

NOTE
If you do not follow these instructions, the video output may not come out as expected.

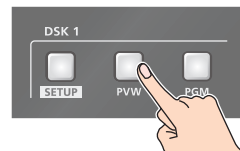
1. Press the DSK [PVW] button or the [PGM] button to turn them off (unlit).
- 
2. Press the [MENU] button to select “Roland Fill+Key”, and press the [VALUE] knob.
 3. Use the [VALUE] knob to select “Mode”, and set the value to “Off”.
This turns off Roland Fill+Key mode.

Swapping and Copying Settings

You can change the stacking order of the DSK layers and copy other DSK layer settings by swapping (exchanging) settings with another DSK layer.

1. Touch the page tab at the top right-hand corner of the DSK setup screen and select "Copy".



2. Touch the screen to access the settings.

Value	Explanation
Copy From DSK 1–2	Lets you copy other DSK layer settings.
Swap With DSK 1–2	Swaps settings with another DSK layer.

Audio Operations

Assigning Audio Sources to Audio Channels

You can assign mic audio, line input, video input (HDMI, SDI) and so on to channels 1–9/10.

This is an example of how to assign a sound source to channel 1.

1. Press the [SETUP] button of the channel whose settings you want to change.



The setup screen for the channel you pressed appears.

2. Touch <Input Fader> and select an audio source to assign to the channel.

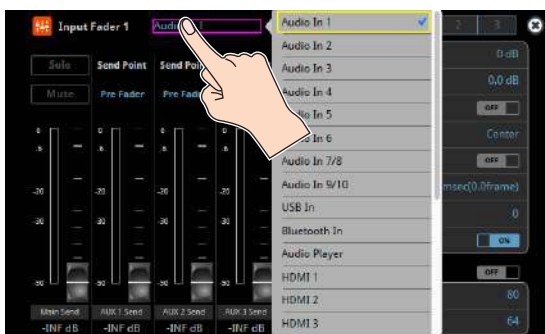

Value	Explanation
Audio In 1–6	Audio from AUDIO IN 1–6 jacks
Audio In 7/8–9/10	Audio from AUDIO IN 7/8–9/10 jacks
USB In	Audio from USB STREAM port
Bluetooth In	Bluetooth In audio
Audio Player	Audio from an audio player
HDMI 1–6 (*1)	Audio from HDMI IN 1–6 connectors
SDI 1–6 (*1)	Audio from SDI IN 1–6 connectors
V.Player/SRT In	Audio from a video player/SRT

(*1) Select channels 1/2, channels 3/4, channels 5/6 or channels 7/8 from SDI or HDMI embedded audio.

3. Press the lit [SETUP] button to close the setup screen.

Adjusting the Input Gain (Sensitivity)

Here's how to adjust the input gain so that the audio is at the appropriate level.

Here we explain using the channel 1 audio as an example.

NOTE

Turning the [GAIN] knobs may produce a popping noise or cause momentary audio drop-out, but this is not a malfunction.

1. Position the channel 1 audio fader near the "0 dB".

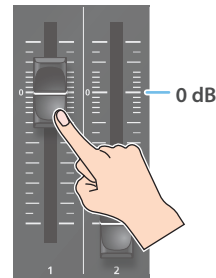

2. Move the [MAIN] fader to a position near the "0 dB".

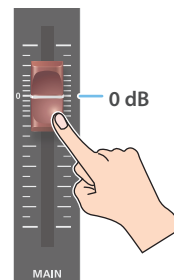

3. Turn the channel 1 [GAIN] knob fully counter-clockwise, minimizing (0 dB) the input gain.



MEMO

For the Audio In 1–6 (which have analog gain circuits), you can turn this knob to adjust the analog gain. For other jacks/ports/connectors, this adjusts the digital gain instead.

4. While producing the sound that will actually be input, slowly turn the [GAIN] knob clockwise to adjust the input gain.

Raise the input gain as high as possible without allowing the SIG/PEAK indicator of channel 1 to light red when the loudest sound level occurs.

NOTE

If the Audio Fader/Knob Mode is set to "Catch", the fader operations are ignored until the fader's position "catches up" to the current level. (p. 160)

* The [SETUP] button for the respective channel blinks while the fader operations are being ignored.

MEMO

Stereo link function

You can link two channels to operate them as a stereo channel.

This can be set for channels 1–6. Press the [SETUP] button for the channel whose settings you want to edit, and turn “Stereo Link” ON.

- * When stereo link is turned on, the settings of that channel are applied to the other channel in the stereo pair.
- * When stereo link is on, the audio fader can't be used for the other channel in the stereo pair.
- * When phantom power is on and you switch the stereo link setting on/off, phantom power automatically turns off.

Adjusting the mic position (pan)

The left/right positioning of the sound is called “pan”. If you're using two mics to stream a performance, panning the two mics to left and right will give the sound a more spacious feel.

This can be set for channels 1–6. Press the [SETUP] button of the channel whose setting you want to change, and adjust the “Pan”.

SIG/PEAK indicator

Indicator	Status
Red	Volume is excessive (0 dB or higher)
Yellow	Volume is appropriate (-20 – -1 dB).
Green	Volume is insufficient (-50 – -21 dB).

Adjusting the digital gain

You can adjust the digital gain for all inputs. Analog gain adjusts the analog sound, and digital gain adjusts the digital sound.

When a high-level audio signal is input to the HDMI or SDI digital audio inputs, distortion may occur due to effect processing.

You can use digital gain to keep the input level down so that there is no impact on effect processing.

Adjusting the Volume Balance

Here's how to adjust the volume balance of each input and the overall volume.

1. Move the [MAIN] fader to a position near the “0 dB”.

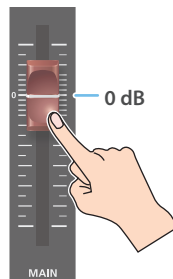

2. While monitoring the audio via speakers or headphones, adjust the volume balance for the respective inputs.

Raise the volume level of audio you want to make more prominent, for example, an emcee microphone, and lower the volume level for other audio. When no audio is input, and for audio that is unused, lower the volume level to minimum (-INF dB).

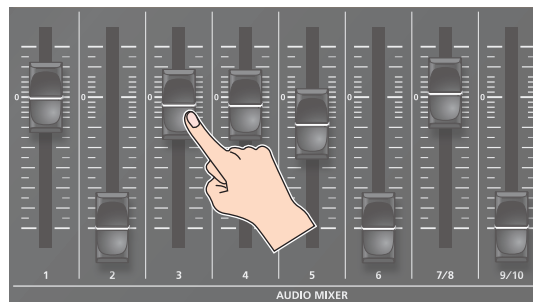

3. Use the [MAIN] fader to adjust the volume of the output.

The MAIN level meter will light yellow at the appropriate volume.

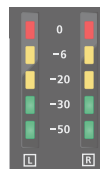

Indicator	Status
Red	Volume is excessive (0 dB or higher)
Yellow	Volume is appropriate (-20 – -1 dB).
Green	Volume is insufficient (-50 – -21 dB).

NOTE

If the Audio Fader/Knob Mode is set to “Catch”, the fader operations are ignored until the fader's position “catches up” to the current level. (p. 160)

- * The [SETUP] button for the respective channel blinks while the fader operations are being ignored.

Adjusting the Volume Balance from the Mixer Screen

The mixer screen on this unit's display lets you adjust the various volumes while checking their values.

1. Press the [AUDIO LEVEL] button.



The Audio Level screen appears.

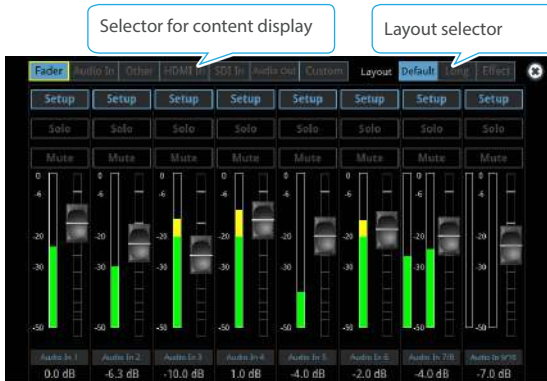

2. Drag the faders on the screen to adjust the volumes.



You can switch between content displays and layout by using the tabs at the top of the screen.

Content displayed	Explanation
Fader	Audio source assigned to a channel
Audio In	Audio from AUDIO IN 1–9/10 jacks
Other	Audio from USB STREAM port, Bluetooth In, Audio player, Video player/SRT input
HDMI In	Audio from HDMI IN 1–6 connectors
SDI In	Audio from SDI IN 1–6 connectors
Audio Out	Output from Main bus, AUX 1–3 buses, USB Out, Stream/Record
Custom	Custom settings. This lets you freely assign the inputs and outputs.

Layout	Explanation
Default	The standard layout.
Long	Layout with longer fader travel.
Effect	Layout which shows other parameters such as effects.

3. Press the [AUDIO LEVEL] button to close the screen.

Applying Effects to Input Audio

You can apply effects to the input audio to adjust the character of the sound. The following table shows the effects that are available.

Input audio	High-pass filter	Echo canceller	Anti-feedback	Noise gate	De-esser	Compressor	Equalizer	Voice changer	Delay	Reverb
Audio In 1, 2	✓	✓	✓	✓	✓	✓	✓	✓	✓	✓
Audio In 3–6	✓	—	—	✓	✓	✓	✓	—	✓	✓
Audio In 7/8–9/10	✓	—	—	✓	—	✓	✓	—	✓	✓
USB In	✓	—	—	✓	—	✓	✓	—	✓	✓
Bluetooth In	✓	—	—	✓	—	✓	✓	—	✓	✓
HDMI In, SDI In	✓	—	—	✓	—	✓	✓	—	✓	✓
Audio Player, Video Player/SRT In	✓	—	—	✓	—	✓	✓	—	✓	✓

1. Press the [SETUP] button for the channel to which you wish to apply effects.

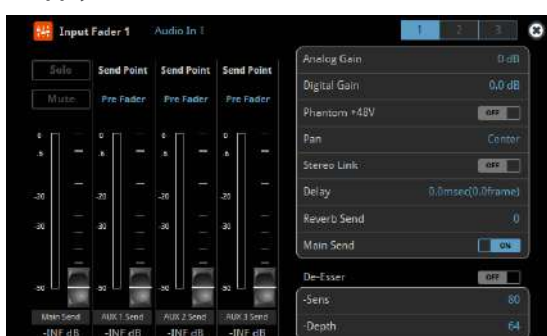

The setup screen for the channel you pressed appears.

2. Touch the screen to configure the effects.

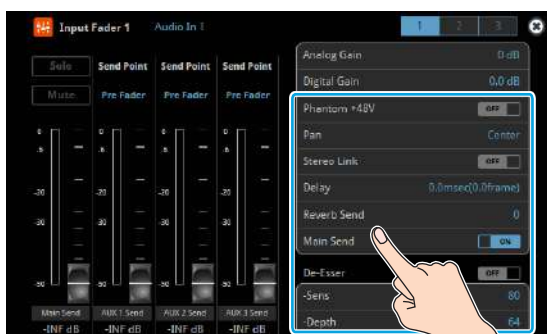

- * The settings screen for the high-pass filter, compressor, equalizer and noise gate is on page 2.
- * For details on the parameters, refer to “8: Audio Input” (p. 117).

3. Press the lit [SETUP] button to close the setup screen.

● High-pass filter

Cuts off unneeded low-band audio.

● Echo canceller (p. 53)

Suppresses the voice echo that can occur when using a web conferencing system that includes a speaker and mic.

● Anti-feedback (p. 53)

Suppresses audio feedback.

● Noise gate

Eliminates audio that is lower than the specified threshold level. This is effective when the noise that you want to remove is separate from the audio that you want to keep, and can be used to remove hiss or other noise that is heard during periods of silence.

● De-esser

Reduces sibilant noise (the sounds you hear when pronouncing “s” words and other hissing sounds).

● Compressor

Audio that exceeds the specified threshold level is compressed. This reduces the difference between the maximum volume and minimum volume, making the audio more comfortable for listening.

● Equalizer

This is a four-band equalizer. It lets you adjust the volume by boosting or cutting four frequency regions.

● Voice changer (p. 53)

Transforms the pitch or character of the voice.

● Delay (p. 53)

Outputs audio with a delay.

● Reverb (p. 54)

Adds reverberation to the sound.

Using an Effect Preset

The VR-120HD is equipped with effects that are adjusted for specific environments. These are called “effect presets”.

The effect presets are created using a combination of four effects (high-pass filter, compressor, equalizer, noise gate).

Simply by selecting an effect preset, you can easily apply an effect that’s appropriate for your situation.

MEMO

- To make detailed adjustments to a preset, edit the high-pass filter, compressor, equalizer and noise gate settings on the channel setup screen (page 2).
- You cannot overwrite the effect presets. Use the scene memories to save the settings for presets you’ve edited (p. 78).
- When you load an effect preset, each preset setting is restored to its default setting (factory defaults).

1. Touch the page tab at the top right-hand corner of the channel setup screen to select page 2.

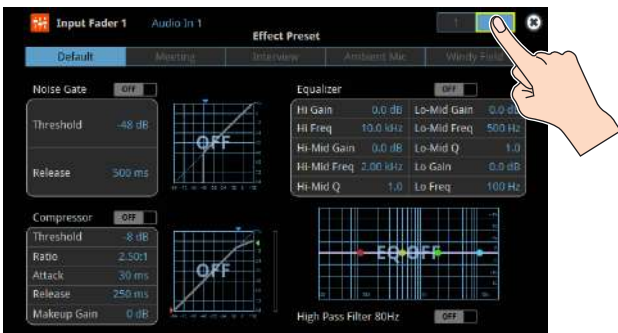

2. Select an effect preset by touching the screen.

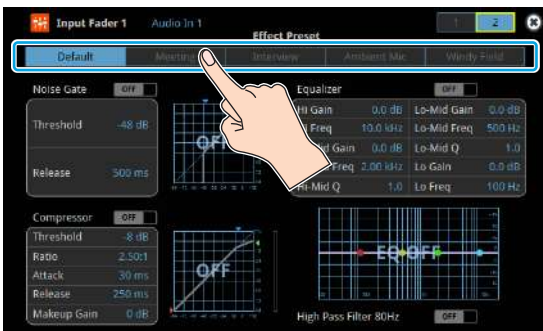

Value	Explanation
Default	For line input (default setting)
Meeting	For meetings
Interview	For interviews
Ambient Mic	For capturing ambient sound
Windy Field	For capturing ambient sound in a windy area

A confirmation message appears.

* If you decide to cancel, press the [EXIT] button.

3. Use the [VALUE] knob to select “OK”, and press the [VALUE] knob.

The effect preset is loaded.

4. Configure the settings for each effect as necessary.

Touch the onscreen graphics to enlarge the settings for the effect. You can also directly drag a point on the graph onscreen to edit.

Noise gate

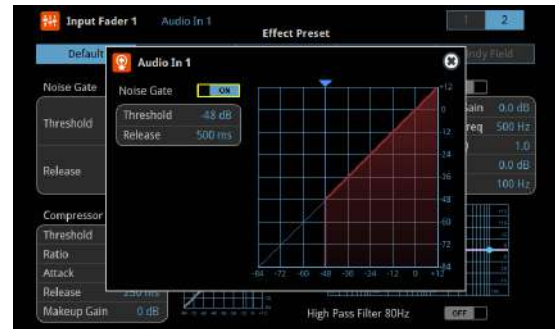

Compressor

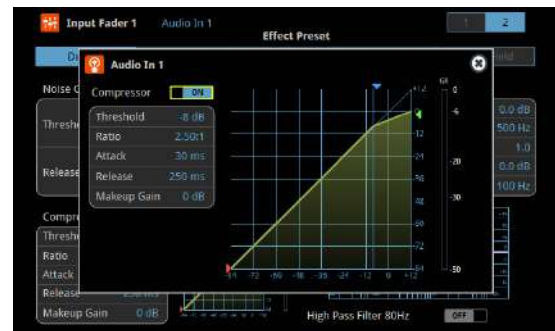

Equalizer, High-pass filter

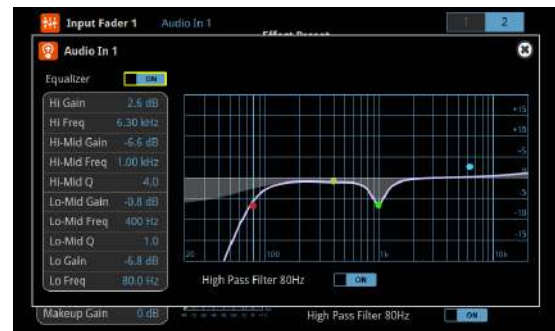

* For details on the parameters, refer to “8: Audio Input” (p. 117).

Suppressing Echo in a Web Conference System (Echo Canceller)

In a conversation using the speaker and mic of a web conference system, an echo can occur when the other person's voice heard through the speaker is picked up by the mic and sent back to the other person.

When you use the echo canceller, the echo component is removed from the voice that is picked up by a mic connected to the VR-120HD, so that only your own voice is sent to the other party.

* This only works on the input audio from the AUDIO IN 1, 2 jacks.



Parameter	Explanation
Echo Canceller	Turns the echo canceller on/off.
Depth	Adjusts the depth of the echo canceller.

MEMO

- The echo canceller supports rooms that are approximately 20 m² (215 sq ft).
- If your own voice returns to you as an echo, you'll need the other party to make echo canceller settings.
- The echo canceller works based on audio input from the USB In port.

Reducing Acoustic Feedback (Anti-Feedback)

Here's how to reduce the acoustic feedback that can occur when a mic is brought near a speaker.

* This only works on the input audio from the AUDIO IN 1, 2 jacks.



Parameter	Explanation
Anti-Feedback	Turns the anti-feedback on/off.

Changing the Character of a Voice (Voice Changer)

Here's how to modify the pitch or character of the voice that's input from a mic.

You can create transformations such as "from a female to a male voice", "from a male to a female voice", or "robot voice".

* This only works on the input audio from the AUDIO IN 1, 2 jacks.



Parameter	Explanation
Voice Changer	Turns the voice changer on/off.
Pitch	Adjusts the pitch of the voice in semitone steps. A setting of "0" is the original pitch.
Formant	Adjusts the character (formant) of the voice. Settings in the negative (-) direction produce a more masculine vocal character, and settings in the positive (+) direction produce a more feminine vocal character. A setting of "0" is the original voice.
Robot	When this is "ON", the voice is held at a fixed pitch, creating a mechanical robot-like impression.
Mix	Adjusts the balance between the unprocessed voice (0) and the voice processed by the effect (100).

MEMO

You can assign the function to an AUDIO EFFECT button to switch the voice changer on/off (p. 97).

Correcting a Time Difference Between Video and Audio (Delay)

If there is a timing discrepancy between the video and audio, you can correct the output timing by delaying the input audio.



Parameter	Explanation
Delay	Adjusts the delay time of the audio.

Applying Reverb

This adds reverberation to the sound.

Adjusting how much reverb to send

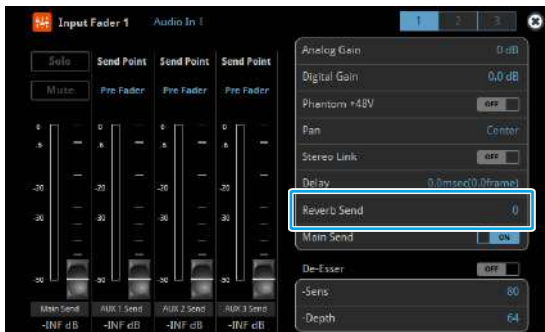

Parameter	Explanation
Reverb Send	Adjusts the amount of audio sent to reverb.

Adjusting how much reverb is returned

* Adjust how much reverb is returned from the audio effect setup screen.

1. Press the AUDIO EFFECT [SETUP] button to turn on (lit).

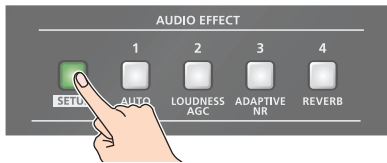

The Audio Effect Assign setup screen appears.

2. Press the AUDIO EFFECT [REVERB] button to turn on (lit).

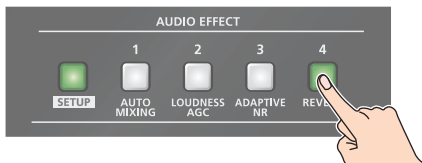

Reverb turns on.

3. Touch Audio Effect 4 <Setup>.

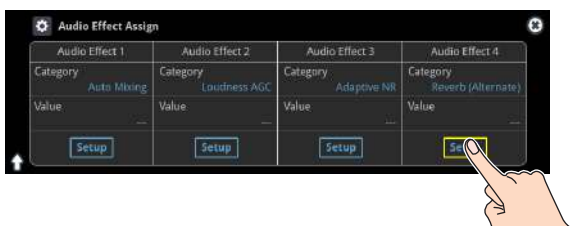

The Audio Effect setup screen appears.

4. Touch the screen to access the settings.

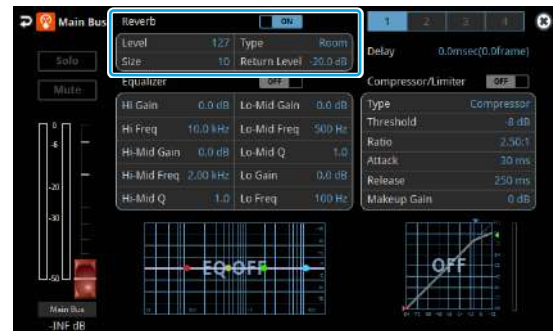

Parameter	Explanation
Level	Specifies the amount of sound that is returned from the reverb (return level). This adjusts the depth of the overall reverb.
Type	Specifies the reverb type. Room: Produces the natural-sounding reverberation of a room. Hall: Produces the reverberation that is typical of a performance in a concert hall.
Size	Specifies the size of the room. The larger the value, the longer the reverb time.

5. Press the lit [SETUP] button to close the setup screen.

Applying Effects to Output Audio

Here's how to modify the tonal character by applying effects. The following table shows the effects that are available.

Audio bus	Reverb	Equalizer	Delay	Compressor/Limiter	GEQ	Adaptive NR	Loudness AGC
Main Bus	✓	✓	✓	✓	✓	✓	✓
AUX Bus 1 AUX Bus 2 AUX Bus 3	✓	✓	✓	✓	✓	—	—

1. Press the MAIN [SETUP] button.

The Audio Output screen appears.

2. Touch <Setup> for each bus.

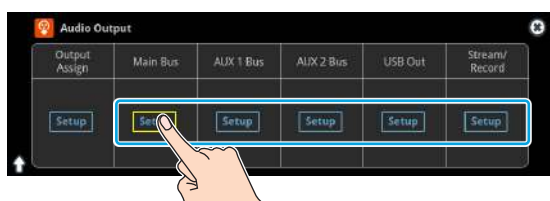

The setup screen appears for the bus you selected.

3. Touch the screen to access the settings.

* For details on the parameters, refer to "9: Audio Output" (p. 135).

4. Press the lit [SETUP] button to close the setup screen.

● Equalizer

This is a four-band equalizer. It lets you adjust the volume by boosting or cutting four frequency regions.

● Delay

Outputs audio with a delay. Delaying the output lets you correct timing problems in the audio signal that is input to the output destination device.

● Compressor/Limiter

Compresses audio levels that exceed the threshold you set, or limits the output level so that it does not exceed the threshold.

● Graphic Equalizer

It lets you shape the character of the sound by boosting or cutting each of the 15 frequency regions into which the sound is divided.

● Adaptive Noise Reduction (p. 56)

By continuously monitoring the input audio to detect noise during periods of silence, this removes only the noise component.

● Loudness Auto Gain Control (p. 57)

The long-term average loudness is measured, and the volume is adjusted so that it is appropriate overall.

Interlinking Audio Output to Video Switching (Audio Follow)

Here's how the audio output can be automatically switched in tandem with video switching (the audio follow function).

1. [MENU] button → select "Audio Follow", and press the [VALUE] knob.
2. Use the [VALUE] knob to select the input video that uses audio follow.



Touch "All Off" or "All On" to set everything all at once.

3. Press the [VALUE] knob to turn it "ON".

Value	Explanation
ON	The audio is output only when the video is selected. The audio is automatically muted if another video is selected.
OFF	The audio is always output regardless of the video selection.

4. Press the [MENU] button to close the menu.

Adding an Object for Audio Follow

You can set Audio Follow to apply to the audio from the Audio In, USB In or Bluetooth In.

1. [MENU] button → "Audio Follow" → and select the audio input that will be the object of Audio Follow.



2. Use the [VALUE] knob to select one of "Input 1"–"Input 8".

Value	Explanation
Input 1–8 HDMI 1–6 SDI 1–6 Still 1–16 V.Player/SRT In	For each audio source, these settings specify the input video that will use the audio follow function. Audio is output only when the specified input video is selected.
Off	The audio is always output regardless of the video selection.

3. Press the [MENU] button to close the menu.

MEMO

You can synchronize the audio with the on/off state of the PinP&Key or DSK (p. 144).

Removing Noise from the Audio (Adaptive Noise Reduction / Low Frequency Cut)

You can remove noise from the input audio. Two effects are provided: "adaptive noise reduction" and "low frequency cut".

● Adaptive Noise Reduction

By continuously monitoring the input audio to detect noise during periods of silence, this removes only the noise component. Unlike conventional noise reduction that removes sound of a specified frequency, this analyzes the frequency of the noise and removes it as appropriate for the environment, resulting in a more natural sound.

* The presence or absence of voice in the input signal is determined according to the "Talking Detector" settings.

● Low Frequency Cut

This divides the region below 200 Hz into four bands, and cuts unneeded low-frequency regions while continuously analyzing each band. Unlike conventional low cut, this does not weaken the sound of the low-frequency region.

Adaptive Noise Reduction

1. Press the AUDIO EFFECT [SETUP] button to turn on (lit).

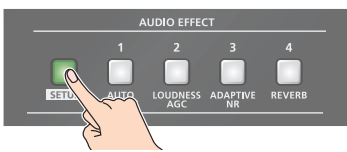

The Audio Effect Assign setup screen appears.

2. Press the AUDIO EFFECT [ADAPTIVE NR] button to turn on (lit).

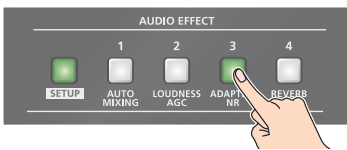

Adaptive noise reduction function turns on.

3. Touch Audio Effect 3 <Setup>.

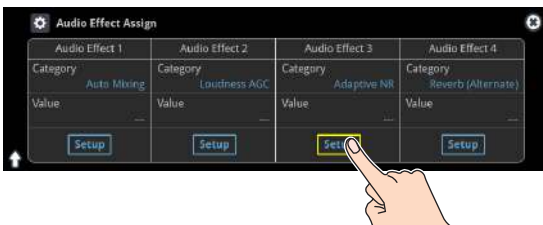

The adaptive noise reduction setup screen appears.

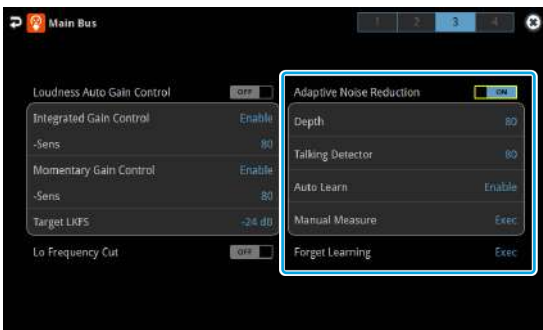

4. Touch <Auto Learn> to set it to "Enable".

The noise is automatically detected, and the noise is reduced.

* If you want to detect noise manually, touch Manual Measure <Exec>. When you touch Manual Measure <Exec>, measurement occurs automatically. When measurement finishes, the message "Completed" appears.

5. Touch <Depth> to set the depth (how aggressive the noise reduction is).

6. If the ambient noise level is high, touch <Talking Detector> to adjust the sensitivity.

* Increasing the value raises the sensitivity of the talking detector, making detection easier even in noisy environments.

7. If you want to reset the noise-reduced result to its original state, touch <Forget Learning>.

* For details on the menu, refer to "9: Audio Output" (p. 135).

Low Frequency Cut

Configure the Low Frequency Cut on the same page of the setup screen for Adaptive Noise Reduction.

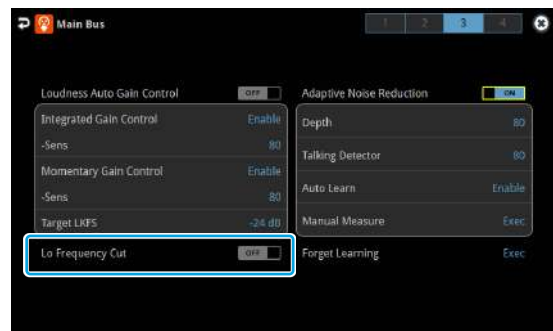

1. Touch <Lo Frequency Cut> to turn it "ON".

Low frequency cut turns on.

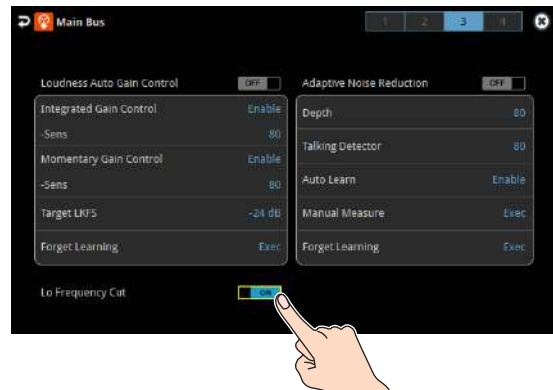

Automatically Setting a Comfortable Volume (Auto Mastering Effect)

Based on “loudness” (an index of perceptual volume), this automatically adjusts the volume appropriately for broadcast. Loudness measurement can be either long-term or short-term; these differ in the interval of time to which volume adjustment applies.

● Loudness Auto Gain Control (Loudness AGC)

The long-term average loudness is measured, and the volume is adjusted so that it is appropriate overall. Use this for audio whose dynamics you want to preserve, such as music.

Loudness Auto Gain Control (Loudness AGC)

1. Press the AUDIO EFFECT [SETUP] button to turn on (lit).

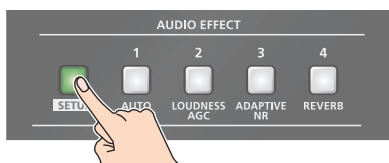

The Audio Effect Assign setup screen appears.

2. Touch Audio Effect 2 <Setup>.



The loudness auto gain control setup screen appears.

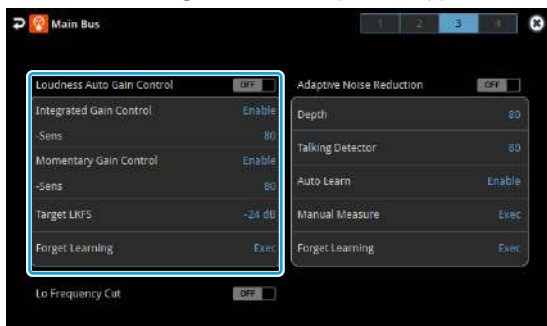

3. Touch <Target LKFS> to set the target level for the output audio.
4. Press the AUDIO EFFECT [LOUDNESS AGC] button to turn on (lit).



Loudness auto gain control function turns on.

5. Touch <Sens> and then use the [VALUE] knob to adjust the sensitivity, adjusting the speed at which the target level (Target LKFS) is approached.

* High settings make the loudness approach the target level rapidly, and low settings make the loudness approach the target level gradually.

6. To reset the adjusted value and return to the original state, touch <Forget Learning>.

* For details on the menu, refer to “9: Audio Output” (p. 135).

Controlling the Volume Automatically (Auto Mixing)

The volume adjustments that would normally be done by the operator can be controlled automatically (auto mixing function).

Since this lets you leave the volume adjustments up to the VR-120HD, it can be used in situations where there is no dedicated operator. This is especially useful for meetings, discussions, debates, and other situations where multiple microphones are used.

1. Press the AUDIO EFFECT [SETUP] button to turn on (lit).

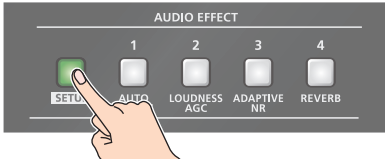

The Audio Effect Assign setup screen appears.

2. Touch Audio Effect 1 <Setup>.

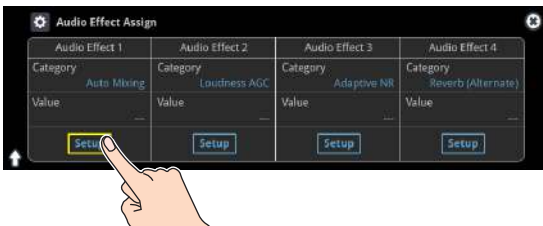

The auto mixing setup screen appears.



3. Press the AUDIO EFFECT [AUTO MIXING] button to turn on (lit).

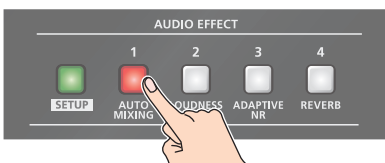

Auto mixing function turns on.

4. Touch the screen to specify whether auto mixing is enabled or disabled for each audio source.

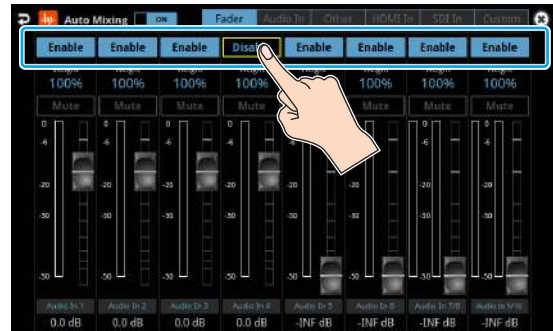

Auto mixing is applied to audio sources that are set to "Enable". For audio that does not require auto mixing, such as background music, choose "Disable".

5. Touch the screen to set the priority for volume distribution (Weight).

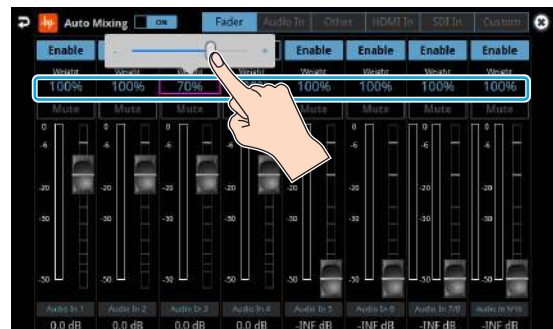

If there is audio that you want to make more prominent, such as when you want to raise the volume level of an emcee microphone, raise the weight level of that audio to emphasize it, and lower the weight level for other audio.

When air-conditioner noise or the like is a concern, specify the weight level to a low value.

6. Press the AUDIO EFFECT [SETUP] button to close the menu.
7. To turn off auto mixing function, press the AUDIO EFFECT [AUTO MIXING] button once again.

Silencing Only Specific Audio (Mute)

Here's how you can temporarily mute specific audio (the mute function).

Muting Input Audio

1. Press the [MUTE] button on the channels you wish to mute.



The button lights up, and the mute function turns on.

Setting on the audio level screen

1. Press the [AUDIO LEVEL] button. The Audio Level screen appears.
2. Touch <Fader> tab.
3. Touch <Mute> on the channel you wish to mute. The mute function for the selected channel turns on.

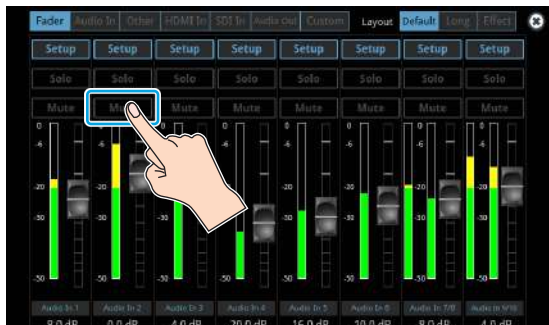

MEMO

You can also mute the channels by touching <Mute> on the setup screen of the respective channel.

Muting the Output Audio

This shows you how to mute the audio from the main bus, USB output, and AUX 1–3 buses.

1. Press the MAIN [MUTE] button.



The button lights up, and the mute function turns on.

Setting on the audio level screen

1. Press the [AUDIO LEVEL] button. The Audio Level screen appears.
2. Touch <Audio Out> tab.
3. Touch <Mute> on the bus you wish to mute. The mute function for the selected bus turns on.



MEMO

You can also mute the buses by touching <Mute> on the setup screen of the respective channel.

Checking a Specific Audio Input (Solo)

Here's how you can temporarily monitor a specific audio input via the headphones (solo function).

* The solo function applies to the headphone output. It does not affect output other than the headphones.

Soloing the Input Audio

1. Press the [SOLO] button on the channels you wish to solo.



The button lights up, and the solo function turns on.

In the headphones, you hear only the audio of the channels that are set to solo.

Setting on the audio level screen

1. Press the [AUDIO LEVEL] button. The Audio Level screen appears.
2. Touch <Fader> tab.
3. Touch <Solo> for the channel you wish to solo. The solo function for the selected channel turns on.



MEMO

You can also solo the channels by touching <Solo> on the setup screen of the respective channel.

Soloing the Output Audio

This shows you how to solo the audio from the main bus and AUX 1–3 buses.

1. Press the MAIN [SOLO] button.



The button lights up, and the solo function turns on.

Setting on the audio level screen

1. Press the [AUDIO LEVEL] button. The Audio Level screen appears.
2. Touch <Audio Out> tab.
3. Touch <Solo> for the bus you wish to solo. The solo function for the selected bus turns on.

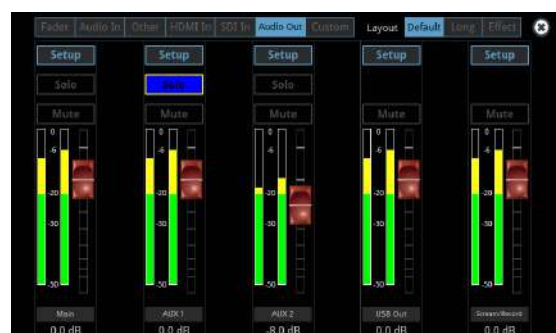
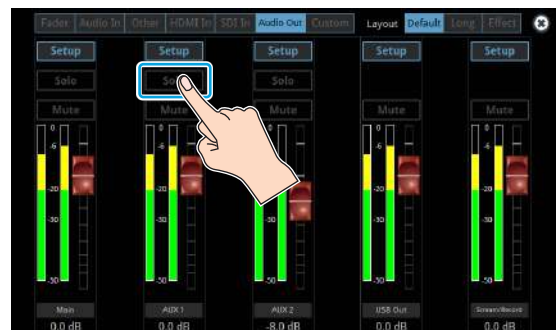

MEMO

You can also solo the buses by touching <Solo> on the setup screen of the respective channel.

Playing Back Audio Files (Audio Player)

Audio files that you created on your computer can be loaded (imported) into this unit as materials, and then played back by using the pads. You can save up to 16 audio files on this unit.

Importing an Audio File

To begin, save the audio files that you created on your computer beforehand to the root directory of your SD card or USB flash drive. Here's an example of how to import an audio file into pad [1].

1. Insert the SD card containing material files into the SDXC card slot.
 - * When using a USB flash drive, connect the USB flash drive to the USB HOST port.

2. Press the AUDIO PLAYER [SETUP] button.



The Audio Player screen appears.

3. Touch Player Setup <Setup>.
 - The Audio Player setup screen appears.

4. Touch <1> in the audio clip area.



The audio clip setup screen appears.

5. Touch Import <Enter>.



A list of audio files on your storage media is shown.

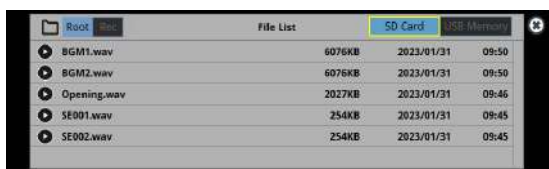

- * Use the "SD Card" or "USB Memory" selector at the top right-hand corner of the screen to switch between the storage media to load from.
 - * Select "Root" or "Rec" in the upper left part of the screen to switch between folders from which the files are loaded.
6. Touch the filename of the audio file you want to load.
 - * You can audition the file in headphones by touching the preview icon (🔊).
 7. When the confirmation dialog box appears, select "OK" and press the [VALUE] knob.

The file is imported, and the data is placed in pad [1] (Audio Player 1) as an audio clip.

Supported files

Format	WAV (Linear PCM, 48 kHz, 16 bit, stereo/ 44.1 kHz, 16 bit, stereo)
File name	No more than 64 single-byte alphanumeric characters * The extension ".wav" must be added.

Total length of audio files that can be saved to this unit

44.1kHz/16bit	Approx. 17 hours
48kHz/16bit	Approx. 15 hours

* Equivalent to approximately 10 GB file size in total.

Playing Back Audio Clips

1. Set the AUDIO PLAYER [LEVEL] knob to "0dB".



2. Press a pad from [1]–[8] corresponding to the position of the audio clip you want to play back.

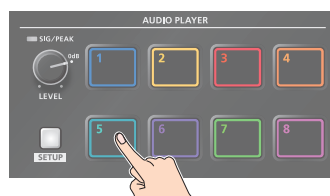

This plays back the corresponding audio clips.

3. While playing back the audio clips, use the AUDIO PLAYER [LEVEL] knob to adjust the overall volume for all audio clips.

Adjust the input gain so that the SIG/PEAK indicator of the audio player doesn't light up red when the sound level is at its loudest.

MEMO

If you leave this information showing on the audio player setup screen, you can play back the audio clips while checking their information (clip name, playback time, loop, etc.).

NOTE

If the Audio Fader/Knob Mode is set to "Catch", the fader operations are ignored until the fader's position "catches up" to the current level. (p. 160)

* The [SETUP] button for the respective channel blinks while the fader operations are being ignored.

Setting an Audio Clip

1. Press the AUDIO PLAYER [SETUP] button.
2. Touch Player Setup <Setup>.
The Audio Player setup screen appears.
3. Touch the number you want to set in the audio clip area.

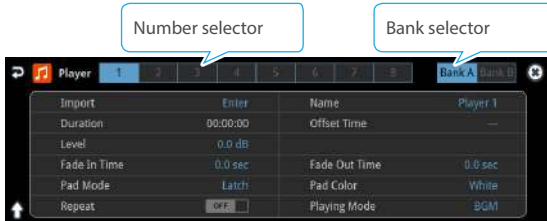

The audio clip setup screen appears.

4. Touch the screen to access the settings.

Parameter	Explanation
Import	Imports the audio file.
Name	Sets the name for an audio clip.
Duration	Shows the length of an audio clip.
Offset Time	Sets the playback start position of the audio clip.
Level	Sets the volume of the audio clip.
Fade In Time	Sets the fade-in time.
Fade Out Time	Sets the fade-out time.
Pad Mode	Sets what happens when the audio clip plays back.
Pad Color	Specifies the color of the corresponding pad when it lights up.
Repeat	When this is set to "ON", the audio clip plays back in a loop.
Playing Mode	Specifies how the audio clip plays back.

* For details on the parameter, refer to "12: Audio Player" (p. 145).

Swapping, copying and deleting clips

You can copy and swap clips, and you can also initialize and delete the audio clips you no longer need.

1. Press the AUDIO PLAYER [SETUP] button.
The Audio Player screen appears.
2. Touch Player Setup <Setup>.
The Audio Player setup screen appears.
3. Touch <Copy>, <Swap> or <Initialize> to make the settings.
The option you touch blinks.

Function	Operation
Copy	Touch the areas for the two audio clips: first the copy source and then the copy destination.
Swap	Touch the areas for the two audio clips you want to swap.
Initialize	Touch the area for the audio clip you want to initialize.

A border appears and blinks around the area you touch.

A confirmation message appears.

4. Select "OK" and press the [VALUE] knob.

Inputting the name of an audio clip

You can give each audio clip a name.

1. Press the AUDIO PLAYER [SETUP] button.
The Audio Player screen appears.
2. Touch Player Setup <Setup>.
The Audio Player setup screen appears.
3. Touch the audio clip area.



The setup screen appears.

4. Touch the clip name.



This brings up the software keyboard for input.

5. Input the desired clip name.
6. Touch <Enter> in software keyboard.



Mixer Settings for the Audio Player

1. Press the AUDIO PLAYER [SETUP] button.

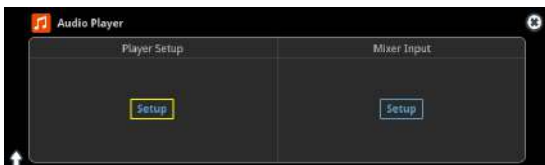

The Audio Player screen appears.

2. Touch Mixer Input <Setup>.

The Audio Player mixer screen appears.



3. Touch the screen to configure the send amount for each bus.

On page 2, you can configure the effects as with the other audio channels.

Outputting AUX-bus Audio

The VR-120HD has five different audio buses: the Main bus, AUX 1 bus, AUX 2 bus, AUX 3 bus and Monitor bus. You can assign a desired bus to each output connector or jack.

Audio bus	Explanation
Main bus	All input audio is mixed and output (main output).
AUX 1 bus AUX 2 bus AUX 3 bus	This mixes and outputs only the input audio that is sent to the AUX bus. This allows you to output audio that is different than the master output. For example, in a live event, you might output a mix of all audio inputs, while separately outputting a mix of only specific audio inputs (the AUX bus) for recording or streaming.
Monitor bus	This outputs the same audio as what you hear in the headphones. Use "Monitor Level" to adjust the volume.

Assigning the AUX Bus

1. Press the MASTER OUT [SETUP] button.

The Audio Output screen appears.

2. Touch Output Assign <Setup>.



The Output Assign screen appears.



3. Touch the screen to configure the bus to assign to each jack or connector.

connector	Selected bus
Audio Out 1 (XLR)– Audio Out 3 (RCA) HDMI Out 1–3 SDI Out 1–3	Main Bus, AUX 1 Bus, AUX 2 Bus, AUX 3 Bus, Monitor Bus
Phones Out/Monitor USB Out Stream/Record Audio Record	Main Bus, AUX 1 Bus, AUX 2 Bus, AUX 3 Bus

Sending Audio to the AUX Bus

* Use the [AUX 1] and [AUX 2] knobs to adjust the volume of audio output from the AUX bus.

1. Press the [SETUP] button for the channel you wish to send to the AUX bus.

The setup screen for the channel you pressed appears.

2. Touch <Aux 1 Send> to set the send amount.

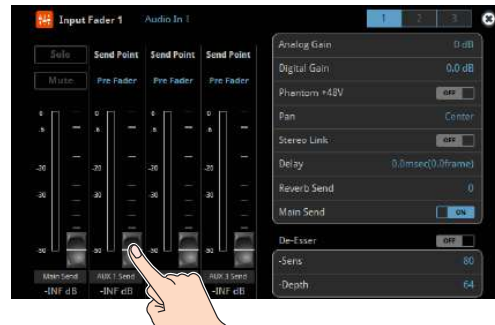

* For the AUX 2–3 bus, touch <AUX 2–3 Send>.

Setting the character of the sound

You can select whether to send either the original audio or the audio processed with effects to the AUX bus.

1. Press the [SETUP] button for the channel you wish to send to the AUX bus.

The setup screen for the channel you pressed appears.

2. Touch <Send Point> to make that setting.

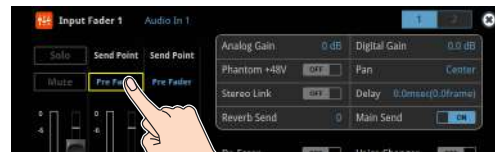

Value	Explanation
Dry	Sends the source audio with no effects applied.
Pre Fader	Sends the effect-applied audio. The send volume is constant, regardless of the volume (Input Level).
Post Fader	Sends the effect-applied audio. The send volume can be changed by adjusting the volume (Input Level).

MEMO

On the setup screens for the Main Bus and AUX 1–3 Bus, you can adjust the send amounts for each channel all at once while checking each channel's status.



NOTE

If the Audio Fader/Knob Mode is set to "Catch", the fader operations are ignored until the fader's position "catches up" to the current level (p. 160).

* The SIG/PEAK indicators for the [AUX 1] and [AUX 2] knobs blink while operations are being ignored.

Adding Input Audio to an HDMI or SDI Video for Output

The HDMI OUT and SDI OUT connectors support 8-channel embedded audio. You can add input audio (sound) to an HDMI or SDI video that is output.

Assigning HDMI/SDI embedded audio and sound

You can assign the input audio signal you like to channels 3–8 of HDMI or SDI embedded audio.

* These settings are common for the HDMI OUT 1–3 and SDI OUT 1–3 connectors.

Embedded-audio	Audio
Channel 1	Bus (L) assigned in Output Assign (p. 64)
Channel 2	Bus (R) assigned in Output Assign (p. 64)
Channel 3/4	Audio In 1/2, Audio In 3/4
Channel 5/6	Audio In 5/6, Audio In 7/8, Audio In 9/10
Channel 7/8	USB In, Bluetooth In, Audio Player
	HDMI 1–6, SDI 1–6, Video Player/SRT In

As a backup for visual or sound recording...

Digital audio is extracted from the HDMI or SDI embedded audio one channel at a time, so after visual recording or sound recording, you can edit the audio channel by channel.

For multilingual support...

Taking multilingual narration or other such audio, making it embedded audio and adding it to HDMI video or SDI video lets you later extract and use the digital audio for the required language.

1. [MENU] button → “Audio Output” → select “HDMI/SDI Audio Embedded”, and press the [VALUE] knob.



Assigning the audio

2. Use the [VALUE] knob to select the HDMI or SDI embedded audio channel, and press the [VALUE] knob.

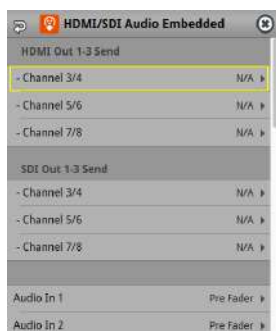

3. Use the [VALUE] knob to select the input audio you wish to assign to the channel, and press the [VALUE] knob.

Input audio	Explanation
Audio In 1–9/10	Audio from AUDIO IN 1–9/10 jacks
USB In	Audio from USB STREAM port
Bluetooth In	Bluetooth In audio
Audio Player	Audio from an audio player
HDMI In 1–6	Audio from HDMI IN 1–6 connectors
SDI In 1–6	Audio from SDI IN 1–6 connectors
Video Player/SRT In	Audio from a video player/SRT

Setting the character of the sound

4. Use the [VALUE] knob to select the input audio, and press the [VALUE] knob.



5. Use the [VALUE] knob to select “Dry”, “Pre Fader”, or “Post Fader”, and press the [VALUE] knob.

Value	Explanation
Off	Audio is not sent.
Dry	Sends the source audio with no effects applied.
Pre Fader	Sends the effect-applied audio. The send volume is constant, regardless of the volume (Input Level).
Post Fader	Sends the effect-applied audio. The send volume can be changed by adjusting the volume (Input Level).

6. Press the [MENU] button to close the menu.

The audio including channel 3–8 embedded audio is output from the HDMI OUT 1–3 connectors or the SDI OUT 1–3 connectors.

Live Streaming

Outputting Video/Audio to a Computer for Streaming

Here's how the video and audio mixed by the VR-120HD can be output to a connected computer. You can also input audio that's played back by the computer.

By using an internet-connected computer with streaming app, you can distribute content as a live internet stream.

In order for the audio and video from the VR-120HD to be correctly viewed on the computer, app that supports the USB video class and USB audio class must be installed on the computer.

* For the latest operating requirements, refer to the Roland website (<https://proav.roland.com/>).

Outputting Video and Audio to the Computer

1. Using a USB 3.0 cable, connect a USB 3.0 port on the computer to the USB STREAM port on the VR-120HD.
2. Turn on the power to the VR-120HD.
3. Start the computer.
When communication with the computer has been established, the computer recognizes the VR-120HD as a USB video device and USB audio device. The first time that the VR-120HD is connected to the computer, the standard drivers of the operating system are installed automatically.
4. Operate the VR-120HD to prepare the video and audio that you want to output to the computer.
5. On your computer, verify the input from the VR-120HD.
Start app that supports the USB video class and audio class, and verify the video and audio that are being input from the VR-120HD.

MEMO

If the video is garbled or operation is otherwise unstable

Press the [MENU] button → "Video Output" → USB Out" → execute "Connection Reset" to try reconnecting the computer with the VR-120HD.

Video formats

You can change the USB output video format and compression method from the livestreaming app or other app used at the output destination.

The following video formats are supported.

USB OUT frame rate	Video formats		
59.94Hz	1080/59.94p	720/59.94p	640 × 480/59.94p
60Hz	1080/60p	720/60p	640 × 480/60p
29.97Hz	1080/29.97p	720/29.97p	640 × 480/29.97p
30Hz	1080/30p	720/30p	640 × 480/30p
50Hz	1080/50p	720/50p	640 × 480/50p
25Hz	1080/25p	720/25p	640 × 480/25p
23.98Hz	1080/23.98p	720/23.98p	640 × 480/23.98p
24Hz	1080/24p	720/24p	640 × 480/24p

* Uncompressed (YUY2) and compressed (Motion JPEG) video are supported.

Using the Loopback Function

Audio from the computer can be input to the VR-120HD via USB, mixed with other audio, and returned to the computer (the loopback function).

You can add a narration to music that's played back from your computer and live-stream it, or record it using app on your computer.

Streaming Video from a Computer

Use the dedicated "Roland Live Streamer" app to stream the video and audio from the USB output of the VR-120HD with your computer.

For details on operation, refer to the Owner's Manual of "Roland Live Streamer".



You can download "Roland Live Streamer" from the Roland website.

<https://proav.roland.com/>

* Compressed (Motion JPEG) video is not supported.

Capturing Video on the Computer

Using dedicated "Roland Live Recorder" app, the video and audio that are output from the VR-120HD via USB can be recorded on your computer.

For details on operation, refer to the Owner's Manual of "Roland Live Recorder".



You can download "Roland Live Recorder" from the Roland website.

<https://proav.roland.com/>

* Compressed (Motion JPEG) video is not supported.

What to do when an HD video (1920 x 1080) output via USB changes to SD video (640 x 480)

If you are using a USB cable that doesn't conform to USB 3.0 specs or later, the video output resolution is changed to SD (640 x 480). To output video for streaming to your computer in HD (1920 x 1080), be sure to use a cable that meets the USB 3.0 specs (or later).

* If you connect via an extension cable or a USB hub, the computer might not recognize the unit.

You can check the status of the connected USB cable by following these steps.

1. [MENU] button → "Video Output" → select "USB Out", and press the [VALUE] knob.

This shows the status of the USB cable that's connected.

Output Status	Status
Connected (3.0)	Connected using USB 3.0.
Connected (2.0)	Connected using USB 2.0.
Not Connected	No connection.

Streaming/Capturing Video Directly

Network Requirements

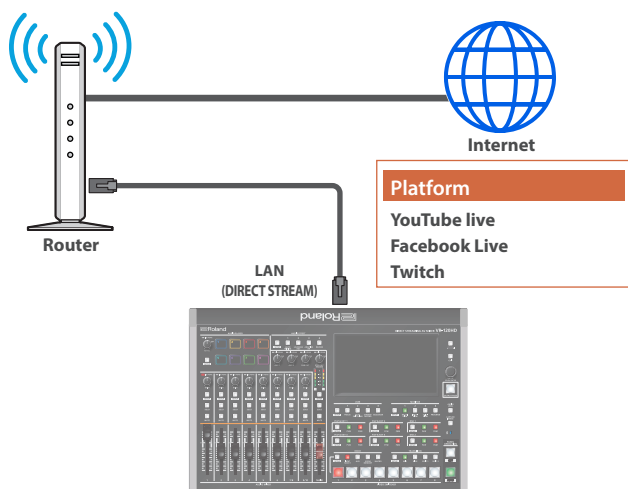

Internet connection, including DNS server settings

- To access the Internet, the IP address, subnet mask and default gateway must be configured.
 - To access the server hosting the streaming service, you must connect to the DNS (Domain Name System) server, which converts the server's domain name and IP address.
- * The above settings are usually retrieved from the DHCP server and assigned.

Continuous TCP communications

To broadcast the livestream via the RTMP or RTMPS protocol over TCP, continuous communication without interruptions or restrictions between devices is required.

HTTPS connection to an Internet server

To configure the livestream for a Web app, you must have an HTTPS connection to an Internet server.

Points to Be Aware of When Livestreaming

Set the appropriate Video Bitrate (p. 146) to match the speed of your Internet connection.

Press the [MENU] button → "Stream/Record" → "Target Bitrate" → select "Video".

The video bit rate is a target bit rate that's used when compressing (encoding) video.

For complex video sequences and the like, the video may be livestreamed at a bit rate of up to around 1.5 times the value that's set.

We recommend that you test the speed of your Internet connection to ensure that a bandwidth of around twice the Video Bitrate value is available before beginning the livestream.

Starting/Stopping the Livestream, Audio or Video Recording

The livestream, audio recording and video recording on the VR-120HD start and stop all at the same time, and cannot be started or stopped separately.

- * You can separately set whether to livestream, record audio or video.

Turning Livestreaming, Audio and Video Recording ON/OFF

MEMO

When the streaming/recording function is assigned to a USER button, you can set this from the setup screen.

- * The streaming/recording setup screen function is assigned to the USER [3] button by factory default.

NOTE

- If either the streaming and recording format or the file played by the video player exceeds 1080/30p, the streaming and recording and video player functions cannot be used simultaneously.
- If the bitrate setting for Streaming and Recording and the bitrate of the file played on Video Player exceeds 20,000 kbps, Streaming and Recording and Video player cannot be used simultaneously.

Turning the livestream on/off

1. Press the USER [SETUP] button.

The User Assign screen appears.

2. Touch User 3 <Setup>.

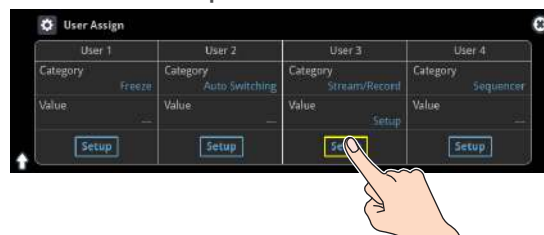

The Record/Stream setup screen appears.



3. Touch the page tab at the top right-hand part of the screen to select page 2.
4. Touch either Service 1 or Service 2 to select the platform for streaming.

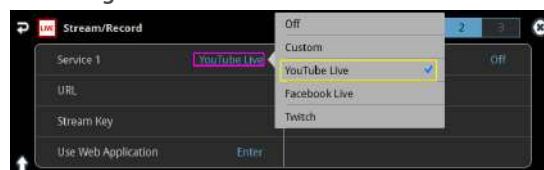

Select "Off" when you're not streaming.

Turning video and audio recording on/off

5. Touch the page tab at the top right-hand part of the screen to select page 3.
6. Touch "Video Rec" and "Audio Rec" to turn them on/off.



Livestreaming via YouTube Live

Getting ready

- Create a Google account beforehand.
- Make sure that the VR-120HD is connected to the Internet for livestreaming.
- To record audio/video, set Audio Rec and Video Rec to "On" (p. 68).

Operating this unit

1. On the streaming/recording setup screen (page 2), touch either <Service 1> or <Service 2> and select "YouTube Live".



2. Touch <Use Web Application>.

The shortened URL and QR code for the Web app are shown.



Operating your computer or smartphone

3. On the Web browser of your computer or smartphone, open the link that's shown.
4. Select your Google account.
5. Set the following parameters.

Item	Explanation	
Title	Input the title of the livestream.	
Description	Input the description to be shown on YouTube Live for your content.	
Select privacy scope	Public	Anyone can search for and view the content.
	Unlisted	The content can be accessed only via the link.
	Private	Only the content creator (publisher) can view the content.
Select latency Preference	Selects the latency setting.	
	normal	Normal latency
	low	Low latency
	ultralow	Ultra-low latency

6. Click "CREATE BROADCAST AND GET STREAM KEY".
7. Click "SEND TO DEVICE".

When the data transmission is finished, the message "Success" appears.

The URL and stream key are applied to the VR-120HD.

NOTE

Don't close the QR code screen until the "URL" and "Stream Key" have been applied.

8. Click "OK".
9. Close the page.

Operating this unit

10. Select page 1 on the streaming/recording setup screen.
The parameters for stopping/starting the livestream, audio and video recording are shown in the status area.



11. Touch <ON AIR>.
The message "Are you sure you want to start streaming?" is shown.
12. Touch <OK>.
Livestreaming starts.
If audio/video recording is turned on, the audio/video starts at the same time as the livestream.
13. Touch <ON AIR> once more to stop streaming.
The message "Are you sure you want to stop streaming?" is shown.
14. Touch <OK>.
The livestream ends.

NOTE

- Stream keys that are acquired have an expiration date, so they need to be acquired prior to livestreaming.
- When acquiring the stream key, you can select a livestream for which the schedule has already been set by using "SELECT YOUR BROADCAST".

MEMO

You can assign streaming start/stop to the USER buttons. On the User Assign screen, select the "Stream/Record" Category, and select "Start/Stop" for Value.



Livestreaming via Facebook Live

Getting ready

- Create a Facebook account beforehand.
- Make sure that the VR-120HD is connected to the Internet for livestreaming.
- To record audio/video, set Audio Rec and Video Rec to "On" (p. 68).

Operating this unit

1. On the streaming/recording setup screen (page 2), touch either <Service 1> or <Service 2> and select "Facebook Live".



2. Touch <Use Web Application>.
The shortened URL and QR code for the Web app are shown.



Operating your computer or smartphone

3. On the Web browser of your computer or smartphone, open the link that's shown.
4. Log in to your Facebook account.
5. Set the following parameters.

Item	Explanation	
Title	Input the title of the livestream.	
Description	Input the description to be shown on Facebook Live for your content.	
Select destination for live-streaming	Sets where to "post" the livestream (meaning who can view the content).	
	Timeline	The content is streamed to your personal timeline.
	Page	The content is streamed to a Facebook page.
Select privacy scope	Selects the privacy settings (the scope of release) for the livestream.	
	SELF	The livestream is only visible to you.
	ALL FRIENDS	Only friends can view the livestream.
	EVERYONE	Anyone can view the livestream.

6. Click "SUBMIT TO DEVICE!".
When the data transmission is finished, the message "Success" appears.
The URL and stream key are applied to the VR-120HD.

NOTE

Don't close the QR code screen until the "URL" and "Stream Key" have been applied.

7. Click "OK".
8. Close the page.

Operating this unit

9. Select page 1 on the streaming/recording setup screen.
The parameters for stopping/starting the livestream, audio and video recording are shown in the status area.

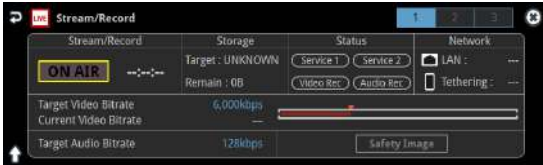

10. Touch <ON AIR>.
The message "Are you sure you want to start streaming?" is shown.
11. Touch <OK>.
Livestreaming starts.
If audio/video recording is turned on, the audio/video starts at the same time as the livestream.
12. Touch <ON AIR> once more to stop streaming.
The message "Are you sure you want to stop streaming?" is shown.
13. Touch <OK>.
The livestream ends.

NOTE

Facebook stream keys that are acquired have an expiration date, so they need to be acquired prior to livestreaming.

MEMO

You can assign streaming start/stop to the USER buttons. On the User Assign screen, select the "Stream/Record" Category, and select "Start/Stop" for Value.



Livestreaming via Twitch

Getting ready

- Create a Twitch account beforehand.
- Make sure that the VR-120HD is connected to the Internet for livestreaming.
- To record audio/video, set Audio Rec and Video Rec to "On" (p. 68).

Operating this unit

1. On the streaming/recording setup screen (page 2), touch either <Service 1> or <Service 2> and select "Twitch".



2. Touch <Use Web Application>.
The shortened URL and QR code for the Web app are shown.



Operating your computer or smartphone

3. On the Web browser of your computer or smartphone, open the link that's shown.
4. Log in to your Twitch account.
5. Select the server to connect to in "Select ingest server location".
To stream your content in a more stable network environment, select a server in a region that's close to you.
* You can still livestream, regardless of which server you choose.
6. Click "SUBMIT TO DEVICE!".
When the data transmission is finished, the message "Success" appears.
The URL and stream key are applied to the VR-120HD.

NOTE

Don't close the QR code screen until the "URL" and "Stream Key" have been applied.

7. Click "OK".
8. Close the page.

Operating this unit

9. Select page 1 on the streaming/recording setup screen.

The parameters for stopping/starting the livestream, audio and video recording are shown in the status area.

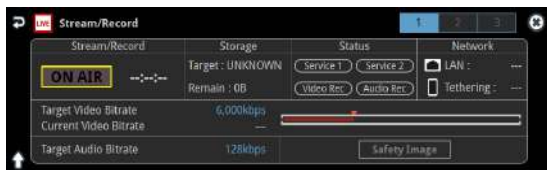

10. Touch <ON AIR>.

The message "Are you sure you want to start streaming?" is shown.

11. Touch <OK>.

Livestreaming starts.

If audio/video recording is turned on, the audio/video starts at the same time as the livestream.

12. Touch <ON AIR> once more to stop streaming.

The message "Are you sure you want to stop streaming?" is shown.

13. Touch <OK>.

The livestream ends.

MEMO

You can assign streaming start/stop to the USER buttons.

On the User Assign screen, select the "Stream/Record" Category, and select "Start/Stop" for Value.

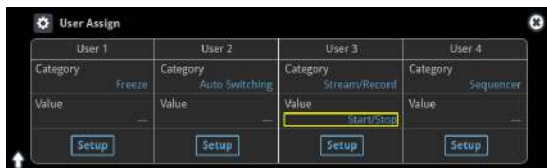

Streaming with Custom Settings

Getting ready

- Make sure that the VR-120HD is connected to the Internet for livestreaming.
- To record audio/video, set Audio Rec and Video Rec to "On" (p. 68).

Operating this unit

1. On the streaming/recording setup screen (page 2), touch either <Service 1> or <Service 2> and select "Custom".



2. Touch <Use Web Application>.

The shortened URL and QR code for the Web app are shown.



Operating your computer or smartphone

3. On the Web browser of your computer or smartphone, open the link that's shown.

4. Input the "RTMP URL" and "Stream Key".

MEMO

You can find the "RTMP URL" and "Stream Key" on the website or other resource of the streaming platform you are going to use.

5. Click "SUBMIT!".

When the data transmission is finished, the message "Success!" appears.

The URL and stream key are applied to the VR-120HD.

NOTE

Don't close the QR code screen until the "URL" and "Stream Key" have been applied.

6. Click "OK".

7. Close the page.

Operating this unit

8. Select page 1 on the streaming/recording setup screen.

The parameters for stopping/starting the livestream, audio and video recording are shown in the status area.

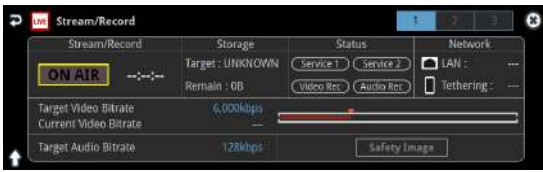

9. Touch <ON AIR>.

The message "Are you sure you want to start streaming?" is shown.

10. Touch <OK>.

Livestreaming starts.

If audio/video recording is turned on, the audio/video starts at the same time as the livestream.

11. Touch <ON AIR> once more to stop streaming.

The message "Are you sure you want to stop streaming?" is shown.

12. Touch <OK>.

The livestream ends.

MEMO

You can assign streaming start/stop to the USER buttons.

On the User Assign screen, select the "Stream/Record" Category, and select "Start/Stop" for Value.



Tethering

You can connect your smartphone to this unit and use it for tethering.

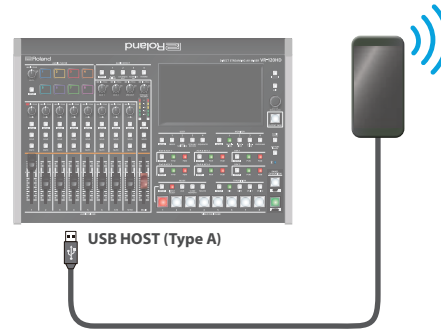

iPhone:

1. Use the Lightning to USB-A cable included with your iPhone to connect to the USB HOST port of the VR-120HD.
2. On your iPhone, select "Settings" → "Personal Hotspot", and turn "Allow Other to Join" on.
3. When you see the message, "Trust this Computer?", tap "Trust".
4. If you see the message "Enter Device Passcode to Trust This Computer", enter your passcode.
5. Select page 3 on the streaming/recording setup screen.



6. Touch <Priority> and select "Tethering"
7. Touch <Start Tethering>.
8. Select page 1 on the streaming/recording setup screen. Once the Network display in the status area changes from "Tethering: ---" to "Tethering: Up", you can use the mobile network connection of your iPhone.



9. To stop tethering, return to page 3 and touch <Stop Tethering>.

Android devices:

NOTE

The method of operation differs depending on the smartphone model. Check the owner's manual for your device for details.

1. Connect the USB HOST port of the VR-120HD to your smartphone with a USB cable.
A notification is shown at the top of your smartphone screen.
2. On your smartphone, select "Settings" → "Network and Internet" → "Hotspot and tethering".
3. Activate "USB tethering".
4. Select page 3 on the streaming/recording setup screen.



5. Touch "Priority" and select "Tethering".
6. Touch <Start Tethering>.
7. Select page 1 on the streaming/recording setup screen.
Once the Network display in the status area changes from "Tethering: ---" to "Tethering: Up", you can use the mobile network connection of your iPhone.



8. To stop tethering, return to page 3 and touch <Stop Tethering>.

MEMO

You can also make the tethering start/stop from the menu.
[MENU] button → "Network" → select "Start Tethering" or "Stop Tethering", and then press the [VALUE] knob.

Avoiding Sporadic Issues When Livestreaming (Safety Delay)

The VR-120HD comes with a built-in "safety delay" function that helps you to avoid unexpected troubles during livestreaming.

You can set the video and audio buffer (streaming delay time: "Stream Delay") for the safety delay function.

If an accidental issue occurs within the streaming delay time, you can control the "switch to still image" and "mute audio" functions with the press of a button, which prevents undesirable content from being streamed.

The safety delay function thus helps you to feel more at ease when livestreaming content, especially in situations like live events where there is no script or guide.

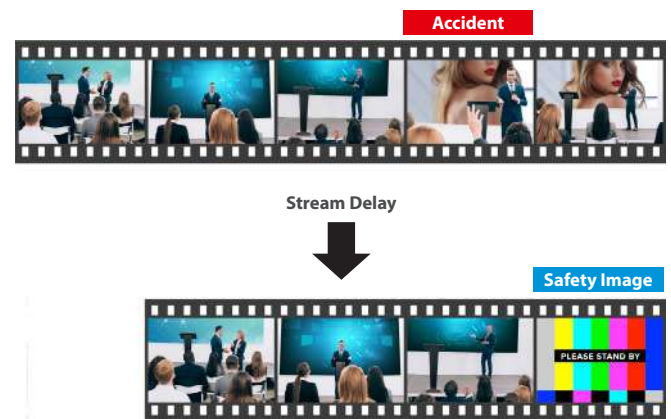

- The streaming delay time can be set in five-second intervals, to a maximum of 60 seconds.
- This unit switches to the still image you imported as the "safety image".
- The unit switches to the safety image only during livestreaming. You can only check the switch to the safety image by looking at the livestreamed video. The image shown on this unit's display or the video outputted via the HDMI OUT connector doesn't switch to the safety image.
- Use this function by assigning the USER buttons to switch to the still image and to mute the audio.

Setting the Streaming Delay Time

1. Select page 3 on the streaming/recording setup screen.



2. Touch <Safety Delay> to configure the setting.

Value

Off, 5 sec–60 sec (five-second intervals)

3. Press the [MENU] button to close the menu.

Using the safety delay function

1. Select page 1 on the streaming/recording setup screen.
2. Touch <ON AIR>.
3. Touch <OK>.
Livestreaming starts.
4. Touch <Safety Image> at the lower right corner of the screen.

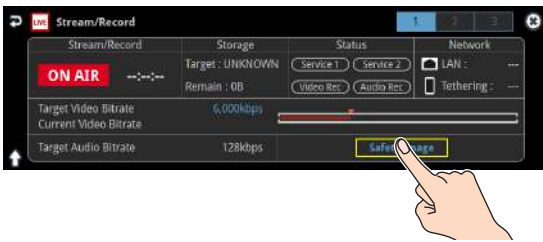

The streaming video switches to a still image, and the streaming audio is muted.

Assigning safety delay to a USER button

You can assign the safety delay function to a USER button. This example shows how to assign the safety delay function to the USER [3] button.

1. Press the USER [SETUP] button.
The User Assign screen appears.
2. For User 3, set the Category to "Stream/Record", and the Value to "Safety Image".

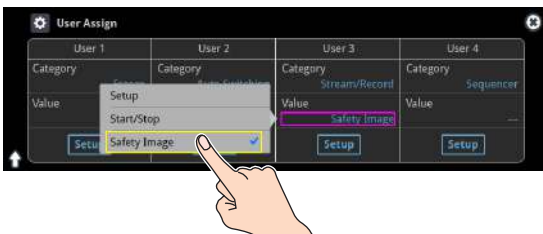

Value	Explanation
Safety Image	The safety delay function switches the streaming video to a still image and mutes the streaming audio.

3. Press the [SETUP] button to close the screen.

Outputting the SRT Video

SRT video output is supported on the VR-120HD. SRT video can be output to a remote SRT-compatible device that's connected to a network. This section describes how to make the necessary connections and output the SRT content, using an SRT video input device connected to your LAN as an example.

* RTMP streaming (p. 67) is not available when outputting SRT video.

Network Requirements



* To output video over a network, the IP address, subnet mask and default gateway must be configured.

These settings are usually retrieved from the DHCP server and assigned.

Connecting an SRT-compatible Device to Output SRT Video

The SRT video signal can be connected from either the transmitting or receiving device, regardless of the orientation of the video signal.

The device that's waiting for the connection is in "listener" mode, and the device that's initiating the connection is in "caller" mode. Depending on the device, one or both modes are supported.

The VR-120HD supports both listener and caller modes.

Connecting in caller mode

In caller mode, configure the transmitting device (VR-120HD) to match the configuration of the receiving device.

Here's how to make an SRT connection from the VR-120HD to the receiving device and output the video from the VR-120HD.

1. Set the SRT mode of the receiving device to listener mode, and input the other settings.

* For details on how to connect and operate in this mode, refer to the owner's manual of the receiving device.

2. Press the [MENU] button → "Stream/Record" → select "Type", and press the [VALUE] knob.

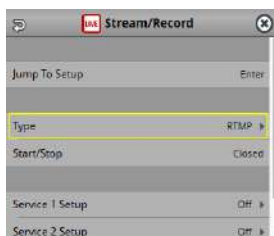

3. Select "SRT Out" and press the [VALUE] knob.
4. Press the [EXIT] button to return to the previous screen.
5. Use the [VALUE] knob to select "SRT Out Setup", and press the [VALUE] knob.

6. Use the [VALUE] knob to select "Mode", and then press the [VALUE] knob.

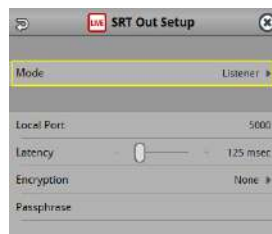

7. Select "Caller" and press the [VALUE] knob.
8. Press the [EXIT] button to return to the previous screen.
9. Use the [VALUE] knob to change the setting as shown below.

Parameter	Explanation
Remote IP Address	Sets the IP address of the SRT receiving device.
Remote Port	Sets the port number of the SRT receiving device.
Latency	Sets the length (delay time) of the SRT retransmission buffer. Out of the latencies set for the receiving and transmitting devices, the one with the larger value takes precedence. Set this as necessary.
Stream ID	If a stream ID is set for the receiving device, set the stream ID to this same ID. * If the stream IDs on the sending and receiving devices do not match, the video cannot be transmitted or received.
Encryption	If you want to encrypt the video, set the encryption method. Configure the same encryption method on the receiving device. * If the encryption methods of the transmitting and receiving devices don't match, the video cannot be transmitted or received.
Passphrase	When setting an encryption method, this sets the passphrase. Set the same passphrase for the receiving device. * If the passphrases of the transmitting and receiving devices don't match, the video cannot be transmitted or received.

MEMO

You can also configure this using the Web app.

The VR-120HD must be connected to the Internet before you use the Web app.

1. Use the [VALUE] knob to select "Use Web Application", and press the [VALUE] knob.
A QR code (URL) appears on the this unit's display.
2. Open the displayed URL on your computer or smartphone.
3. Configure the parameters on your computer or smartphone, and press the [SUBMIT] button.
The settings are applied to the VR-120HD.

10. Press the [EXIT] button to return to the previous screen.
11. Set SRT listener mode on the receiving device.
12. Use the [VALUE] knob to select “Start/Stop”, and press the [VALUE] knob.
The message “Are you sure you want to start streaming?” is shown.
13. Select “OK” and press the [VALUE] knob.
The video is displayed on the receiving device.
You can check the connection status on the GUI screen.

Connecting in listener mode

This shows how to configure the VR-120HD in listener mode to listen for SRT connections.

These are the steps for connecting to the VR-120HD from the receiving device via SRT and outputting the video from the VR-120HD.

In listener mode on the VR-120HD, you can send SRT video to up to three receiving devices.

1. Press the [MENU] button → “Stream/Record” → select “Type”, and press the [VALUE] knob.



2. Select “SRT Out” and press the [VALUE] knob.
3. Press the [EXIT] button to return to the previous screen.
4. Use the [VALUE] knob to select “SRT Out Setup”, and press the [VALUE] knob.
5. Use the [VALUE] knob to select “Mode”, and then press the [VALUE] knob.

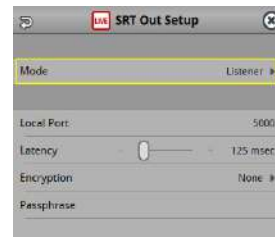

6. Select “Listener” and press the [VALUE] knob.
7. Press the [EXIT] button to return to the previous screen.
8. Use the [VALUE] knob to change the setting as shown below.

Parameter	Explanation
Local Port	Sets the port number used for listening for SRT connections.
Latency	Sets the length (delay time) of the SRT retransmission buffer. Out of the latencies set for the receiving and transmitting devices, the one with the larger value takes precedence. Set this as necessary.
Encryption	If you want to encrypt the video, set the encryption method. Configure the same encryption method on the receiving device. * If the encryption methods of the transmitting and receiving devices don't match, the video cannot be transmitted or received.
Passphrase	When setting an encryption method, this sets the passphrase. Set the same passphrase for the receiving device. * If the passphrases of the transmitting and receiving devices don't match, the video cannot be transmitted or received.

* In listener mode, you do not need to set the Stream ID.

MEMO

You can also configure this using the Web app.

The VR-120HD must be connected to the Internet before you use the Web app.

- 1. Use the [VALUE] knob to select "Use Web Application", and press the [VALUE] knob.**
A QR code (URL) appears on the this unit's display.
- 2. Open the displayed URL on your computer or smartphone.**
- 3. Configure the parameters on your computer or smartphone, and press the [SUBMIT] button.**
The settings are applied to the VR-120HD.

9. Press the [EXIT] button to return to the previous screen.

10. Set the SRT mode of the receiving device to caller mode.

* For details on how to connect and operate in this mode, refer to the owner's manual of the receiving device.

11. Set the caller mode of the receiving device based on the settings in step 8.

* Press the [MENU] button → "Network" → "Network Information" to check the IP address that's set for the receiving device.

12. Use the [VALUE] knob to select "Start/Stop", and press the [VALUE] knob.

The message "Are you sure you want to start streaming?" is shown.

13. Select "OK" and press the [VALUE] knob.

The unit enters SRT listening mode.

14. Perform the operations for connecting on the receiving device.

The video is displayed on the receiving device.

You can check the connection status and the number of connected devices on the GUI Setup screen.

Stopping the SRT connection

The SRT connection can be stopped from either the transmitting or receiving device.

Follow the steps on the VR-120HD as shown below to stop the connection.

1. Press the [MENU] button → select "Stream/Record" → "Start/Stop", and press the [VALUE] knob.

The message "Are you sure you want to stop streaming?" is shown.

2. Select "OK" and press the [VALUE] knob.

* To stop the connection from the receiving device, refer to the owner's manual of that device.

Other Functions

Saving/Recalling Settings (Scene Memory)

You can save the current settings, including the video/audio settings and the state of the operating panel, in scene memory and recall those settings for use when necessary.

The VR-120HD is provided with 32 scene memories.

* The demo data in this unit includes some scene memories by factory default.

About the Last Memory function

The VR-120HD has a built-in Last Memory feature. Last Memory is a feature that saves the state of the unit that is in effect immediately before power-down, and automatically restores the state at the next startup. The Last Memory feature is enabled by default.

If you want the unit to recall a scene memory when it starts up, press the [MENU] button → “Scene Memory” → “Start Up” to specify the scene memory number.

Saving to a Scene Memory

Only for scene memories 1–8

1. Press the [SCENE MEMORY] button.

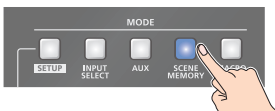

2. Long-press the VIDEO SWITCHER button for the number where you want to save the settings.

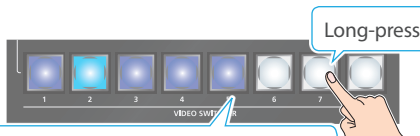

Blue: Memories in which settings are saved
 Light blue: Currently selected memory
 Unlit: Memories with no settings

All VIDEO SWITCHER buttons briefly light up blue, and the current settings are saved in the selected scene memory.

Scene memory 1–32

1. With the [SCENE MEMORY] button lit up, press the MODE [SETUP] button.

The Scene Memory setup screen appears.

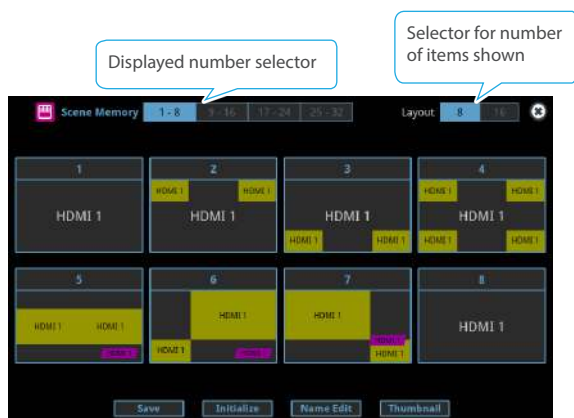

2. Touch <Save>.

The “Save” text blinks.

3. Touch the area of the scene memory number where you want to save.

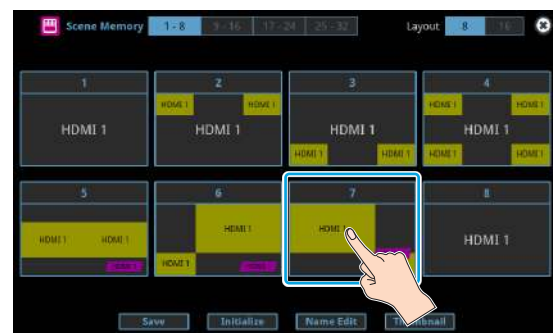

A confirmation message appears.

4. Select “OK” and press the [VALUE] knob.

This saves the current settings to the selected scene memory.

MEMO

About scene memories 9–32

You can use the buttons to save or recall scene memories 9–32.

Press the [MENU] button and select “Scene Memory” → “Button Assign” to set the memory to recall for each VIDEO SWITCHER button.

You can prohibit settings from being saved or initialized (p. 79) to protect the scene memories.

Use the [MENU] button → “Scene Memory” → and set “Memory Protect” to “ON”.

Since settings related to the system, network and so on are common to the entire unit, they are not saved in a scene memory.

About the demo data

Once you perform a factory reset (p. 107), any demo data you have edited or deleted is restored to its factory default settings.

Recalling a Scene Memory

Only for scene memories 1-8

1. Press the [SCENE MEMORY] button.

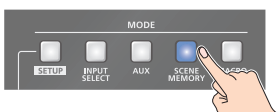

2. Press the VIDEO SWITCHER button for the number whose setting you want to recall.

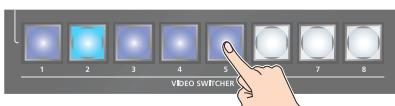

The settings are recalled.

Scene memory 1-32

1. With the [SCENE MEMORY] button lit up, press the MODE [SETUP] button.

The Scene Memory setup screen appears.

2. Touch the area of the scene memory number whose settings you wish to recall.

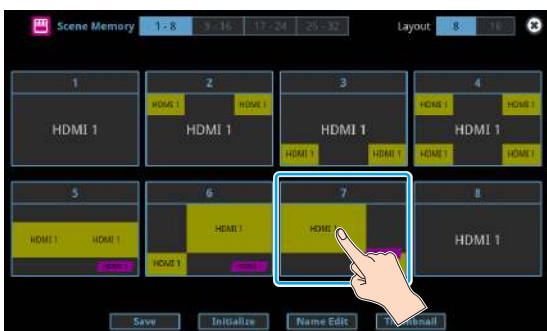

The settings are recalled.

MEMO

- You can choose not to recall a certain setting when recalling a scene memory.
For each item selected using the [MENU] button → “Scene Memory” → “Load Parameters”, you can set whether to recall that setting.
- You can apply video transition effects, make an inset screen fade in and so on when you recall a scene memory.
Configure the settings of the following menu items from the [MENU] button → “Scene Memory”.

Menu item	Explanation
Fade Time	Sets how long the transition to the next video takes when recalling a scene memory. * The time you set is used for the parameters below.
Mix/Wipe	When this is “ON”, the transition effect is applied when the scene memory is recalled.
PinP & Key 1-4	When this is “ON”, the inset screen fades in when you recall a scene memory that includes a PinP composite.
DSK 1, 2	When this is “ON”, the superimposed caption and video fades in when you recall a scene memory that includes a DSK composite.

Initializing a Scene Memory

Here’s how you can initialize the settings of a specific preset memory.

1. With the [SCENE MEMORY] button lit up, press the MODE [SETUP] button.

The Scene Memory setup screen appears.



2. Touch <Initialize>.

The “Initialize” text blinks.

3. Touch the area of the scene memory number that you want to initialize.

A confirmation message appears.

* If you decide to cancel, press the [EXIT] button.

4. Select “OK” and press the [VALUE] knob.

The scene memory is initialized.

Renaming a Scene Memory

Here’s how to rename a preset memory.

1. With the [SCENE MEMORY] button lit up, press the MODE [SETUP] button.

The Scene Memory setup screen appears.

2. Touch <Name Edit>.

The “Name Edit” text blinks.

3. Touch the area of the scene memory number whose name you wish to edit.

This brings up the software keyboard for input.

4. Input the scene memory name.

* You can input up to 8 characters.

5. Touch <Enter> in software keyboard.



6. Touch <Name Edit>.

The “Name Edit” text goes back to being lit up.

Changing the Thumbnail Position

You can change the position of the thumbnail used for checking the video/image content, shown on the scene memory setup screen.

1. With the [SCENE MEMORY] button lit up, press the MODE [SETUP] button.

The Scene Memory setup screen appears.



2. Touch <Thumbnail>.

The "Thumbnail" text blinks.

3. Touch the area of the scene memory number that you want to change.



This shows the thumbnail layout screen.

4. Touch the screen to access the settings.
5. Press the [EXIT] button.

Saving Scene Memories to an SD Card or USB Flash Drive

You can group together the scene memories (1–32) into a single file (.VR120SCENE) and save it to a storage (SD card, USB flash drive,) connected to the VR-120HD. You can access the saved scene memory file on the storage and load it into the unit for use when needed.

* The scene memory file is saved to and recalled from the "Roland/VR-120HD/scene_memory" folder.

NOTE

- When using a SD card or USB flash drive for the first time, you must format it using the VR-120HD (p. 13).
- Never turn off the power or remove the SD card or USB flash drive while the message "Processing..." is shown.
- Depending on the SD card or USB flash drive, it may take some time to be recognized.

Saving a new file

1. Insert the SD card into the SDXC card slot.

* When using a USB flash drive, connect the USB flash drive to the USB HOST port.

2. [MENU] button → "Scene Memory" → select "Save To Storage", and press the [VALUE] knob.

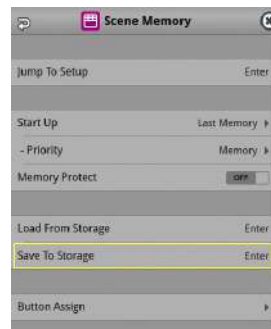

The scene memory files in the storage are listed.

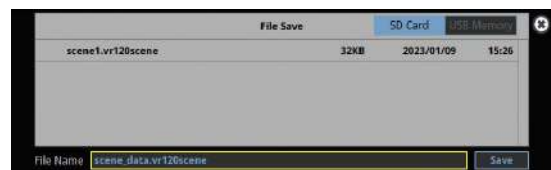

* Use the "SD Card" or "USB Memory" selector at the top right-hand corner of the screen to switch between the storage media to load from.

3. Select "File Name" and press the [VALUE] knob. This brings up the software keyboard for input.
4. Input the scene memory file name.
 - * You can input up to 32 characters.
5. Touch <Enter> in software keyboard.



- Use the [VALUE] knob to select “Save”, and then press the [VALUE] knob.

A confirmation message appears.

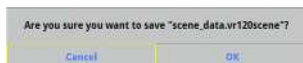

* If you decide to cancel, press the [EXIT] button.

- Use the [VALUE] knob to select “OK”, and then press the [VALUE] knob.

The scene memory file (.VR120SCENE) is saved to the storage.

When the operation is finished, the message “Completed” appears.

- Press the [MENU] button to close the menu.

Overwrite-saving

- Insert the SD card into the SDXC card slot.

* When using a USB flash drive, connect the USB flash drive to the USB HOST port.

- [MENU] button → “Scene Memory” → select “Save To Storage”, and press the [VALUE] knob.

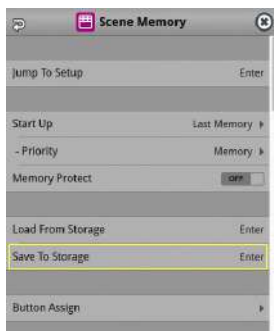

The scene memory files in the storage are listed.

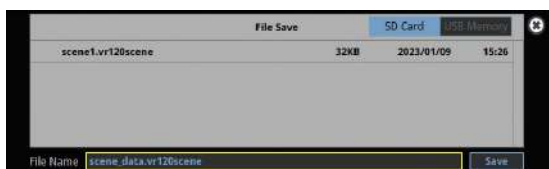

* Use the “SD Card” or “USB Memory” selector at the top right-hand corner of the screen to switch between the storage media to load from.

- Touch the scene memory file that you want to overwrite.

The filename shown in the list of filenames is used.

- Use the [VALUE] knob to select “Save”, and then press the [VALUE] knob.

A confirmation message appears.

* If you decide to cancel, press the [EXIT] button.

- Use the [VALUE] knob to select “OK”, and then press the [VALUE] knob.

The scene memory file is overwritten. When the operation is finished, the message “Completed” appears.

- Press the [MENU] button to close the menu.

Loading

Here’s how to load the scene memory settings that are saved on a storage. Loading the settings overwrites the current settings for the scene memories.

- Insert the SD card into the SDXC card slot.

* When using a USB flash drive, connect the USB flash drive to the USB HOST port.

- [MENU] button → “Scene Memory” → select “Load From Storage”, and press the [VALUE] knob.

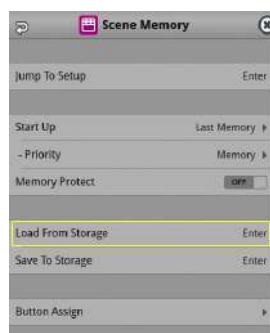

The scene memory files in the storage are listed.



* Use the “SD Card” or “USB Memory” selector at the top right-hand corner of the screen to switch between the storage media to load from.

- Touch the scene memory file that you want to recall.

A confirmation message appears.

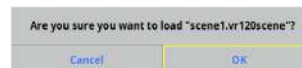
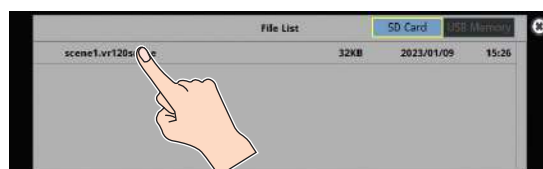

* If you decide to cancel, press the [EXIT] button.

- Use the [VALUE] knob to select “OK”, and then press the [VALUE] knob.

The scene memory settings are loaded. When the operation is finished, the message “Completed” appears.

- Press the [MENU] button to close the menu.

Recording Multiple Operations to Automatically Execute (Macros)

This feature lets you record multiple operations and then automatically execute them (as a macro function). You only need to record the macro operation beforehand and then select the macro to perform the series of operations you recorded. This function is useful for executing exactly the same operations, even when a different operator is using the unit.

You can create up to 100 macros.

Recording a Macro

A single macro can contain up to 10 different operations. You can include a macro within another macro, to make a single macro execute a more complicated set of functions.

* The demo macro data in this unit that's available by factory default includes some recorded operations.

1. Press the [MACRO] button.

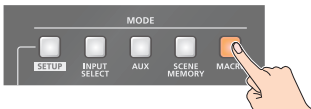

2. Press the MODE [SETUP] button.

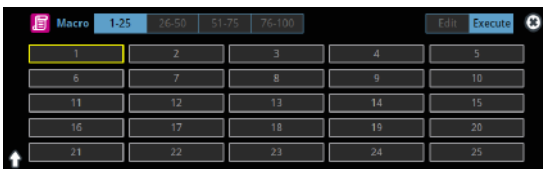

The Macro setup screen appears.

3. Touch <Edit>.

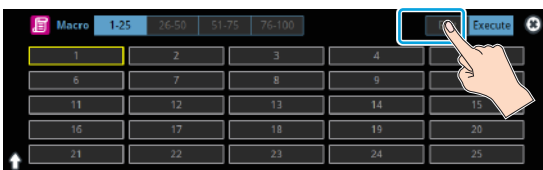

The Macro edit screen appears.

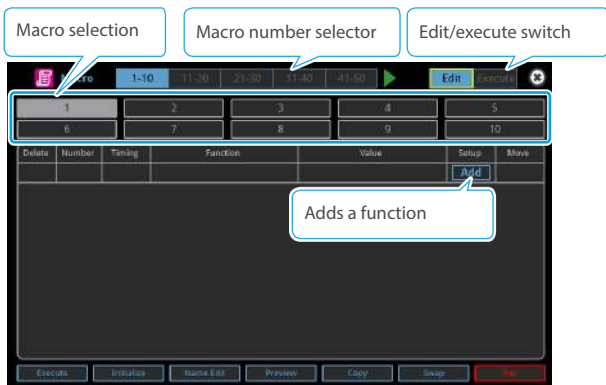

4. Touch the screen to select a macro to edit.

This shows the list of operations recorded in the macro.

5. Touch <Add>.



The function edit menu appears.

6. Touch <Function> to select the operation to record to the macro.

* See "Editing a macro" (p. 83) for details on which operations you can record to a macro.

7. Touch the screen to configure the related parameters.

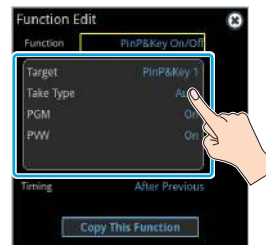

8. Touch <Timing> to set the timing used to execute the operation.

Value	Explanation
After Previous	The function is executed after the preceding one. The next sequential list number is used.
Same As Previous	Executes the operation at the same time as the preceding one. The same list number as the previous operation is used.

* If you place a function at the beginning of the macro, setting the timing has no effect.

9. Press the [EXIT] button to return to the previous screen.



10. Repeat steps 5–9 to finish making the macro.



11. Press the [EXIT] button to close the screen.

Editing a macro

You can edit the contents of a function, change the order in which it is executed, or copy/delete a function either while creating a macro or after the macro is finished.

Editing the contents of a function

- In step 4 of "Recording a Macro" (p. 82), select the function that you want to edit in the list by pressing <Setup>.



The function edit menu appears.

Menu	Value	Explanation
Function	PGM Take	Split Position
	PGM/PST Select	Audio Input Level
	AUX Select	Audio Input Mute
	Input Assign	Audio Output Level
	Transition Time	Audio Output Mute
	Transition Type	Audio Player Control
	PinP&Key On/Off	Video Player Control
	PinP&Key Source	Scene Memory
	PinP&Key Window	Memory Fade Time
	PinP&Key	Memory Fade On/Off
	Cropping	Macro
	PinP&Key View	Output Fade
	DSK On/Off	External Rec Control
	DSK Source	GPO One Shot
	Split Type	GPO Alternate
		Camera Preset Recall
	Wait	

Sets the operation to record to the macro.
* The related menu is shown according to the operation you set.
WAIT:
Sets the waiting time before the next operation is executed.

- Follow steps 5–9 in "Recording a Macro" (p. 82) to edit the operation.



Copying a function

* Copying is disabled if the number of recorded functions have reached the limit (10).

- In step 4 of "Recording a Macro" (p. 82), press <Setup> for the operation you want to copy from the list of operations. The function edit menu appears.
- Touch <Copy This Function>.



The copied operation is added to the last line of the list.

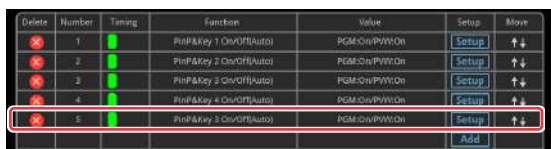

Moving a function

- In step 4 of "Recording a Macro" (p. 82), bring up the operation list.
- Use the <↑↓> (Move) icons shown on the right-hand side to drag the operation line you want to move to the destination, and release it.



This moves the operation line that you dragged.

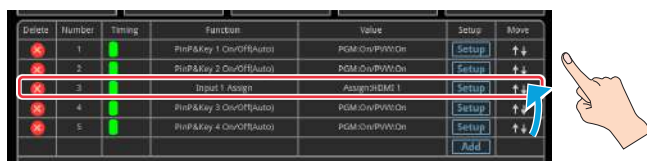

Deleting a function

- In step 4 of "Recording a Macro" (p. 82), bring up the operation list.
- Touch the <X> (Delete) icon to the left of the operation you want to delete.



<Delete> is shown on the right-hand side of the operation line you touched.

- Touch <Delete>.



This deletes the operation line.

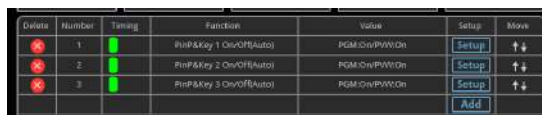

MEMO

What's the difference between "Preview" and "Execute"?

When you touch <Preview> or <Execute> at the bottom of the edit screen, this executes the macro. With "Preview", the action reverts to the previous state once it is executed; but with "Execute", the results are reflected and remain in Program Out.

Directly recording the panel operations to a macro

You can record the panel operations to a macro, just as you did them.

 : Panel operations that can't be recorded to a macro

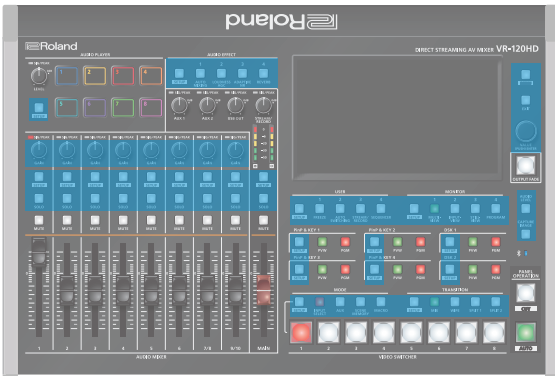

1. In step 4 of “Recording a Macro” (p. 82), bring up the operation list.
2. Touch <Rec>.



The macro recording screen appears.

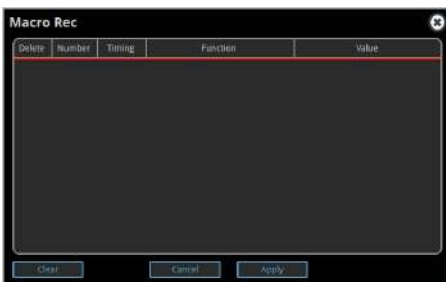

3. Operate the controls you want to record.
Each time you operate a control, the operation is added to the list.
* To stop recording, touch <Cancel>.
* Touch <Clear> to erase all the recorded operations.
4. Touch <Apply> to close the screen.
This confirms the operations you've recorded.

MEMO

Selecting a macro to record with the VIDEO SWITCHER buttons

You can select a macro by long-pressing the VIDEO SWITCHER button that corresponds to the number of the macro you want to record.

Executing a Macro

Only for macros 1-8

1. Press the [MACRO] button.

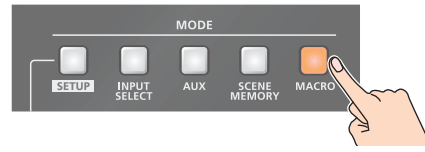

2. Press the VIDEO SWITCHER button corresponding to the number of the macro you wish to execute.

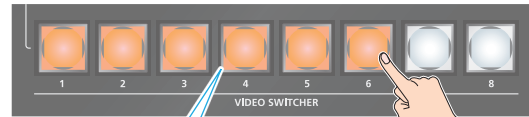

Orange: Macros with a recorded function
Unlit: Macros without a recorded function

This executes the macro.

Macro 1-100

1. Press the [MACRO] button.

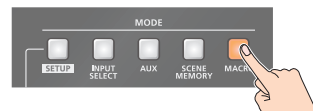

2. Press the MODE [SETUP] button.
3. Touch <Execute>.

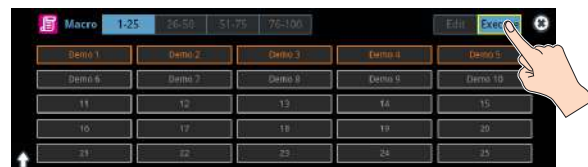

This shows the macro execution screen.

4. Touch the macro (1-100) you want to execute.



This executes the macro.

MEMO

Assigning macros to the VIDEO SWITCHER buttons

You can change which macros are assigned to each VIDEO SWITCHER button.

Press the [MENU] button and select “Macro” → “Button Assign” and then the menu items listed below to assign macros (1-100) to the respective VIDEO SWITCHER buttons.

Copying Macro Settings

Here's how to copy the settings from one macro to another.

1. Follow steps 1–3 in “Recording a Macro” (p. 82) to bring up the macro setup screen.
2. Touch <Copy>.



The “Copy” text blinks.

3. Touch the macros: first the copy source and then the copy destination.



A confirmation message appears.

* If you decide to cancel, press the [EXIT] button.

4. Use the [VALUE] knob to select “OK”, and then press the [VALUE] knob.

The macro settings are copied.

Swapping the Macro Settings

Here's how to swap settings between macros.

1. Follow steps 1–3 in “Recording a Macro” (p. 82) to bring up the macro setup screen.
2. Touch <Swap>.



The “Swap” text blinks.

3. Touch the two macros to swap.



A confirmation message appears.

* If you decide to cancel, press the [EXIT] button.

4. Use the [VALUE] knob to select “OK”, and then press the [VALUE] knob.

This swaps the settings of the macros.

Initializing a Macro

You can initialize a macro and completely erase its settings.

1. Follow steps 1–3 in “Recording a Macro” (p. 82) to bring up the macro setup screen.
2. Touch <Initialize>.



The “Initialize” text blinks.

3. Touch the macro to initialize.



A confirmation message appears.

* If you decide to cancel, press the [EXIT] button.

4. Use the [VALUE] knob to select “OK”, and then press the [VALUE] knob.

The macro is initialized.

MEMO

About the macro demo data

Once you perform a factory reset (p. 107), any demo data you have edited or deleted is restored to its factory default settings.

Renaming a Macro

Here’s how to rename a macro.

1. Follow steps 1–3 in “Recording a Macro” (p. 82) to bring up the macro setup screen.
2. Touch the macro to rename.
3. Touch <Name Edit>.



This brings up the software keyboard for input.

4. Input the macro name.

* You can input up to 8 characters.

5. Touch <Enter> in software keyboard.

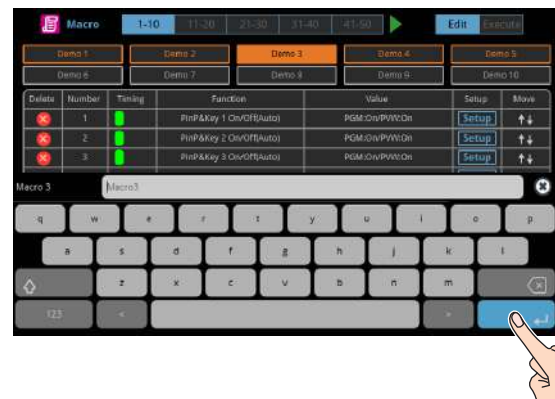

This changes the macro’s name.

Saving/Loading the Macro Settings

You can group together the macro settings (1–100) into a single file (.RMC) and save it to a storage (SD card, USB flash drive,) connected to the VR-120HD. You can access the saved macro setting file on the storage and load it into the unit for use when needed.

* The macro setting file is saved to and recalled from the “Roland/VR-120HD/macro” folder.

NOTE

- When using a SD card or USB flash drive for the first time, you must format it using the VR-120HD (p. 13).
- Never turn off the power or remove the SD card or USB flash drive while the message “Processing...” is shown.
- Depending on the SD card or USB flash drive, it may take some time to be recognized.

Saving a new file

1. Insert the SD card into the SDXC card slot.

* When using a USB flash drive, connect the USB flash drive to the USB HOST port.

2. [MENU] button → “Macro” → select “Save To Storage”, and press the [VALUE] knob.



The macro setting files in the storage are listed.

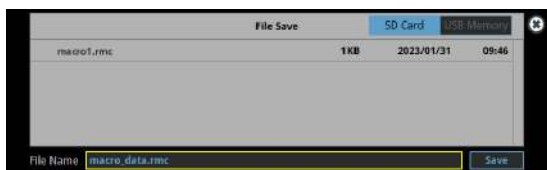

* Use the “SD Card” or “USB Memory” selector at the top right-hand corner of the screen to switch between the storage media to load from.

3. Select “File Name” and press the [VALUE] knob.

This brings up the software keyboard for input.

4. Input the macro setting file name.

* You can input up to 32 characters.

5. Touch <Enter> in software keyboard.



6. Use the [VALUE] knob to select “Save”, and then press the [VALUE] knob.

A confirmation message appears.

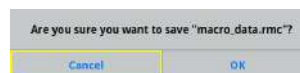

* If you decide to cancel, press the [EXIT] button.

7. Use the [VALUE] knob to select “OK”, and then press the [VALUE] knob.

The macro settings file (.RMC) is saved to the storage. When the operation is finished, the message “Completed” appears.

8. Press the [MENU] button to close the menu.

Overwrite-saving

1. Insert the SD card into the SDXC card slot.

* When using a USB flash drive, connect the USB flash drive to the USB HOST port.

2. [MENU] button → “Macro” → select “Save To Storage”, and press the [VALUE] knob.



The macro setting files in the storage are listed.

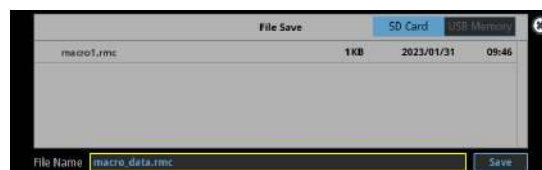

* Use the “SD Card” or “USB Memory” selector at the top right-hand corner of the screen to switch between the storage media to load from.

3. Touch the macro settings file that you want to overwrite.

The filename shown in the list of filenames is used.

4. Use the [VALUE] knob to select “Save”, and then press the [VALUE] knob.

A confirmation message appears.

* If you decide to cancel, press the [EXIT] button.

5. Use the [VALUE] knob to select “OK”, and then press the [VALUE] knob.

The macro settings file is overwritten. When the operation is finished, the message “Completed” appears.

6. Press the [MENU] button to close the menu.

Loading

Here's how to load the macro settings that are saved on a storage. Loading the settings overwrites the current settings for the macros (1-100).

1. Insert the SD card into the SDXC card slot.

* When using a USB flash drive, connect the USB flash drive to the USB HOST port.

2. [MENU] button → "Macro" → select "Load From Storage", and press the [VALUE] knob.

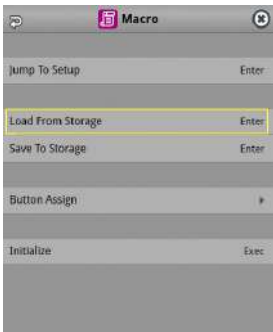

The macro setting files in the storage are listed.



* Use the "SD Card" or "USB Memory" selector at the top right-hand corner of the screen to switch between the storage media to load from.

3. Touch the macro settings file that you want to recall.

A confirmation message appears.

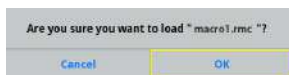

* If you decide to cancel, press the [EXIT] button.

4. Use the [VALUE] knob to select "OK", and then press the [VALUE] knob.

The macro settings are loaded. When the operation is finished, the message "Completed" appears.

5. Press the [MENU] button to close the menu.

Initializing All Macros

Here's how to initialize and erase all the macros.

1. [MENU] button → "Macro" → select "Initialize", and press the [VALUE] knob.

A confirmation message appears.

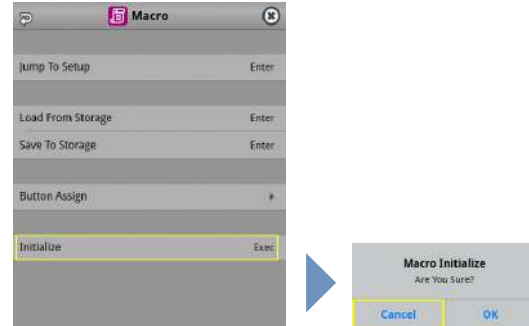

* If you decide to cancel, press the [EXIT] button.

2. Use the [VALUE] knob to select "OK", and then press the [VALUE] knob.

The macros are initialized.

3. Press the [MENU] button to close the menu.

Combining Scene Memories and Macros for Operations (Sequencer)

The sequencer function lets you record functions such as recalling scene memories or macros, and then execute them in the order you specify.

This lets you recreate the desired functions like editing the screen layout or inserting a title, by preparing the functions in line with how the events progress and then simply pressing the [AUTO] button. This feature is useful for smoothly carrying out operations at the place where you're working.

Recording to the Sequencer

Three types of functions can be recorded in the sequencer, including recalling a scene memory, executing a macro and switching between final output videos. Create a list of the functions you want to execute in order.

A list can contain up to 1,000 functions.

MEMO

- The demo data in this unit that's available by factory default includes a list of recorded functions. You can completely erase the contents of this list by initializing it (p. 94).
- When the sequencer function is assigned to a USER button, you can set this from the setup screen.
- * The sequencer function is assigned to the USER [4] button by factory default.

1. Press the USER [SETUP] button.

The User Assign screen appears.

2. Touch User 4 <Setup>.

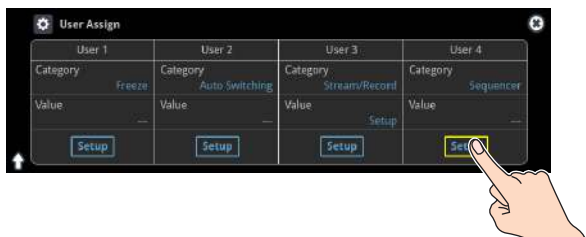

The list of operations recorded in the sequencer is shown.

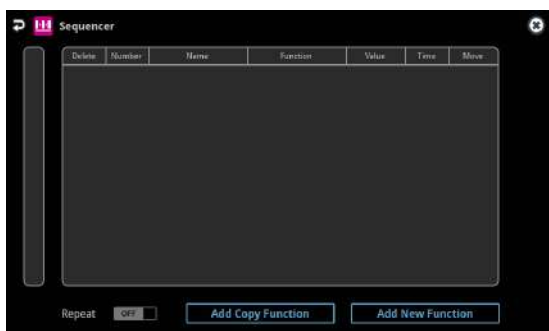

3. Touch <Add New Function>.



The operation is added to the first line of the list.



4. Touch the "Function" column of the line you want to add, and select the operation to record to the sequencer.



Value	Explanation
PGM Take	Switches the final output video.
Scene Memory	Recalls a scene memory.
Macro	Executes a macro.

5. Configure the related parameters.

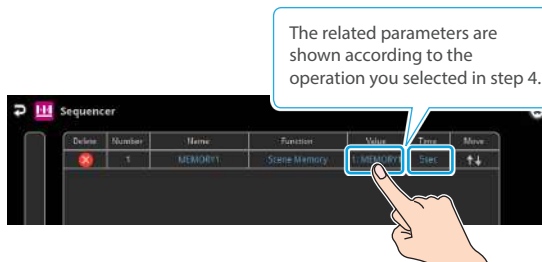

6. Repeat steps 3-5 to finish making the list.



7. Press the [EXIT] button to close the menu.

Editing a list

You can edit the contents of a function, change the order in which it is executed, or copy/delete a function while creating a list or after you've finished the list.

Editing the contents of a function

1. In step 2 of "Recording to the Sequencer" (p. 89), bring up the operation list.
2. Touch the "Function" column of the line you want to edit, and edit the operation to record to the sequencer.



3. Configure the related parameters.

Menu	Value	Explanation
Function	PGM Take	Sets the operation to record to the sequencer. * The related menu is shown according to the operation you set.
	Scene Memory	Switches the final output video. Recalls a scene memory.
	Macro	Executes a macro (a series of recorded operations).
Name	—	Shows the name of the operation.
Time	Pause	Sets the operation when auto sequence is on. Pauses the auto sequence.
	Auto	Executes the next operation in the sequence.
	1-5-120sec	Executes the next operation after delaying for a specified amount of time.

Moving a function

1. In step 2 of "Recording to the Sequencer" (p. 89), bring up the operation list.
2. Use the <↑↓> (Move) icons shown on the right-hand side to drag the operation line you want to move to the destination, and release it.

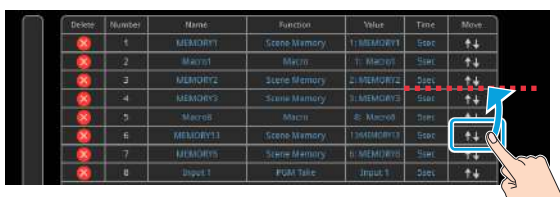

This moves the operation line that you dragged.



Copying a function

1. In step 2 of "Recording to the Sequencer" (p. 89), bring up the operation list.
2. Touch <Add Copy Function>.



The "Add Copy Function" text blinks.

3. Touch the copy source line.

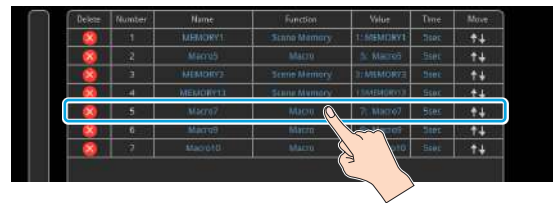

The line is copied and added to the last line of the list.

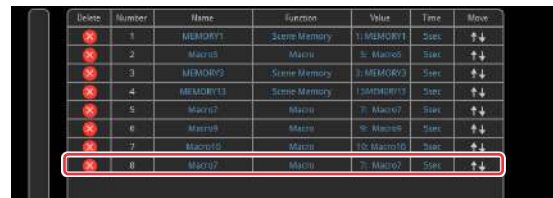

Deleting a function

1. In step 2 of "Recording to the Sequencer" (p. 89), bring up the operation list.
2. Touch the <X> (Delete) icon to the left of the operation you want to delete.



<Delete> is shown on the right-hand side of the operation line you touched.

3. Touch <Delete>.



This deletes the operation line.

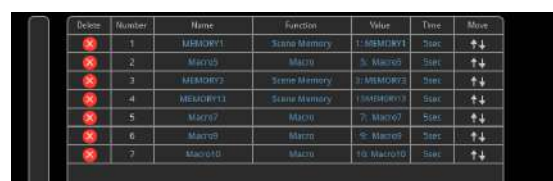

Running the Sequencer

Press the button to make the functions recorded in the sequencer execute one at a time.

1. Press the USER [4] (SEQUENCER) button to turn the sequencer function on (the button lights up).

The sequencer execution screen is shown, where you can check the list of operations that are recorded to the sequencer.

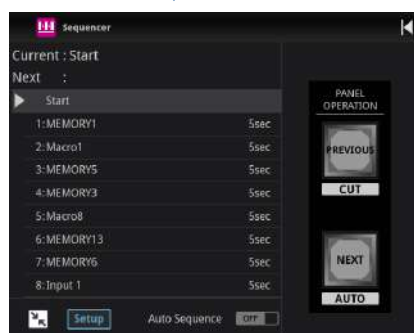
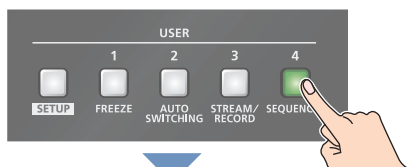

2. Press the [AUTO] (NEXT) button.

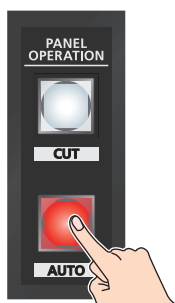

The first function in the list is executed.

The button blinks while the function is executing. When the function ends, the button remains lit.

3. Press the [AUTO] (NEXT) button at the timing when you want the next function to execute.

The function is executed.

[CUT] (PREVIOUS) button

Press the [CUT] button if you want to return to the state at which the previous function was completed.

MEMO

You can also touch <NEXT> or <PREVIOUS> on the screen to operate the sequencer.

4. Repeat step 3.

5. Press the USER [4] (SEQUENCER) button again to turn the sequencer function off.

MEMO

Repeatedly executing a function in the list

You can repeatedly execute functions that are in a list. Once the last function is finished, press the [AUTO] button to execute the function at the beginning of the list.

Use the [MENU] button → "Sequencer" → and set "Repeat Execute" to "ON".

Executing a function from the middle of the list

When you directly touch the desired operation in the list, <Jump> is shown. Touch <Jump> to set that line's operation as completed. You can press the [AUTO] button to execute the next operation afterwards.

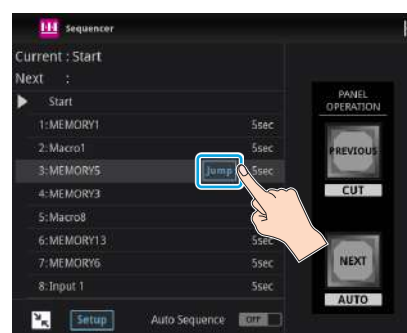

Making the Sequencer Run Automatically (Auto Sequence)

Use the auto sequence feature when you want to make the functions recorded in the sequencer execute automatically.

Configuring the auto sequence settings

Set the action or function that's executed when the sequencer advances to the next function. You can add some delay time before the next function is executed, or pause the execution of a function.

1. In step 2 of "Recording to the Sequencer" (p. 89), bring up the operation list.
2. To change what happens when moving to the next operation, touch the "Time" column of the line you want to edit.

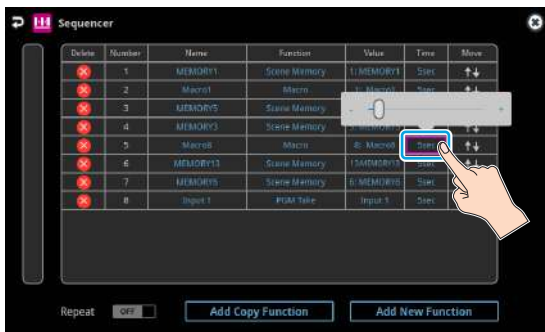

Value	Explanation
Pause	Pauses the auto sequence.
Auto	Executes the next operation in the sequence.
1-120sec	Executes the next operation after delaying for a specified amount of time.

3. Repeat step 2.

Running the auto sequence

1. Press the USER [4] (SEQUENCER) button to turn the sequencer function on (the button lights up).

The list of operations recorded in the sequencer is shown.

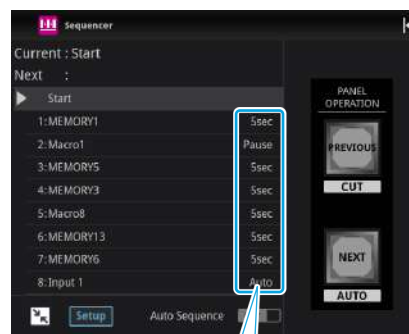
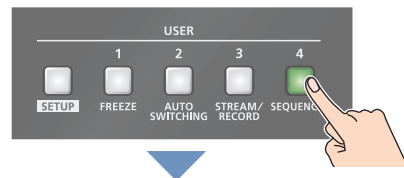

This lets you check which action occurs when the sequencer moves to the next operation.

2. Touch <Auto Sequence> to turn the auto sequencer function on.

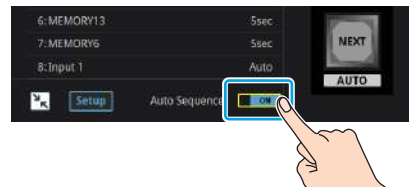

The functions in the list are executed, starting at the beginning. The [AUTO] button blinks while a function is executing.

When the last function is finished, the sequence stops automatically.

When a function is set to "PAUSE"

When the function is finished, auto sequence is paused. You can press the [AUTO] (NEXT) button to manually execute the next function.

* When executing a function that's set to a value other than "PAUSE", the auto sequence is resumed.

3. Touch <Auto Sequence> again to turn off the auto sequence.
4. Press the USER [4] (SEQUENCER) button again to turn the sequencer function off.

MEMO

You can repeatedly execute functions that are in a list. When the last function is finished, the sequencer returns to the beginning.

Use the [MENU] button → "Sequencer" → and set "Repeat Execute" to "ON".

Saving/Loading the Sequencer Settings

You can save the sequencer settings as a single file (.RSQ) to a storage (SD card, USB flash drive) connected to the VR-120HD.

You can access the saved sequence file on the storage and load it into the unit for use when needed.

* The sequence file is saved to and recalled from the "Roland/VR-120HD/sequencer" folder.

NOTE

- When using a SD card or USB flash drive for the first time, you must format it using the VR-120HD (p. 13).
- Never turn off the power or remove the SD card or USB flash drive while the message "Processing..." is shown.
- Depending on the SD card or USB flash drive, it may take some time to be recognized.

Saving a new file

1. Insert the SD card into the SDXC card slot.

* When using a USB flash drive, connect the USB flash drive to the USB HOST port.

2. [MENU] button → "Sequencer" → select "Save To Storage", and press the [VALUE] knob.

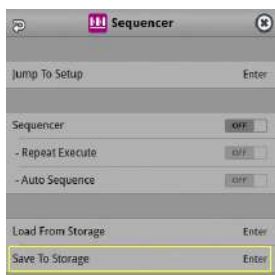

The sequence files in the storage are listed.

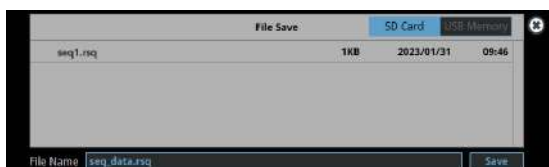

* Use the "SD Card" or "USB Memory" selector at the top right-hand corner of the screen to switch between the storage media to load from.

3. Select "File Name" and press the [VALUE] knob.

This brings up the software keyboard for input.

4. Input the sequence file name.

* You can input up to 32 characters.

5. Touch <Enter> in software keyboard.



6. Use the [VALUE] knob to select "Save", and then press the [VALUE] knob.

A confirmation message appears.

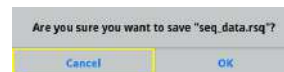

* If you decide to cancel, press the [EXIT] button.

7. Use the [VALUE] knob to select "OK", and then press the [VALUE] knob.

The sequence file (.RSQ) is saved to the storage. When the operation is finished, the message "Completed" appears.

8. Press the [MENU] button to close the menu.

Overwrite-saving

1. Insert the SD card into the SDXC card slot.

* When using a USB flash drive, connect the USB flash drive to the USB HOST port.

2. [MENU] button → "Sequencer" → select "Save To Storage", and press the [VALUE] knob.

The sequence files in the storage are listed.

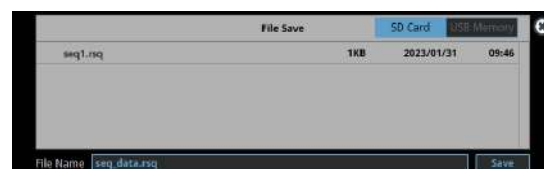

* Use the "SD Card" or "USB Memory" selector at the top right-hand corner of the screen to switch between the storage media to load from.

3. Touch the sequence file that you want to overwrite.

The filename shown in the list of filenames is used.

4. Use the [VALUE] knob to select "Save", and then press the [VALUE] knob.

A confirmation message appears.

* If you decide to cancel, press the [EXIT] button.

5. Use the [VALUE] knob to select "OK", and then press the [VALUE] knob.

The sequence file is overwritten. When the operation is finished, the message "Completed" appears.

6. Press the [MENU] button to close the menu.

Loading

Here's how to load the sequencer settings that are saved on a storage. When you load settings, the current sequencer settings are overwritten.

1. [MENU] button → "Sequencer" → select "Load From Storage", and press the [VALUE] knob.

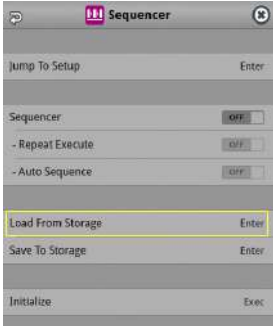

The sequence files in the storage are listed.



* Use the "SD Card" or "USB Memory" selector at the top right-hand corner of the screen to switch between the storage media to load from.

2. Touch the sequence file that you want to load.

A confirmation message appears.

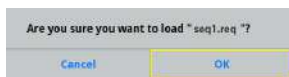

* If you decide to cancel, press the [EXIT] button.

3. Use the [VALUE] knob to select "OK", and then press the [VALUE] knob.

The sequencer settings are loaded. When the operation is finished, the message "Completed" appears.

4. Press the [MENU] button to close the menu.

Initializing the Sequencer

Here's how to initialize the sequencer and erase all the settings.

1. [MENU] button → "Sequencer" → select "Initialize", and press the [VALUE] knob.

A confirmation message appears.

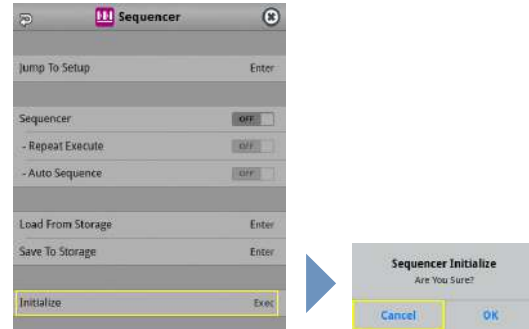

* If you decide to cancel, press the [EXIT] button.

2. Use the [VALUE] knob to select "OK", and then press the [VALUE] knob.
3. Press the [MENU] button to close the menu.

MEMO

About the sequencer demo data

Once you perform a factory reset (p. 107), any demo data you have edited or deleted is restored to its factory default settings.

Backing Up and Restoring the Unit's Settings

You can group together the unit's settings into a single file (.VR120) and back up it to a storage (SD card, USB flash drive) connected to the VR-120HD. You can access the backed up setting file on the storage and restore it into the unit for use when needed.

* The setting file is saved to and recalled from the "Roland/VR-120HD/backup" folder.

NOTE

- When using a SD card or USB flash drive for the first time, you must format it using the VR-120HD (p. 13).
- Never turn off the power or remove the SD card or USB flash drive while the message "Processing..." is shown.
- Depending on the SD card or USB flash drive, it may take some time to be recognized.

Backing Up

Saving a new file

1. Insert the SD card into the SDXC card slot.

* When using a USB flash drive, connect the USB flash drive to the USB HOST port.

2. [MENU] button → "SD Card/USB Memory" → select "Backup All Settings", and press the [VALUE] knob.



The backup files in the storage are listed.

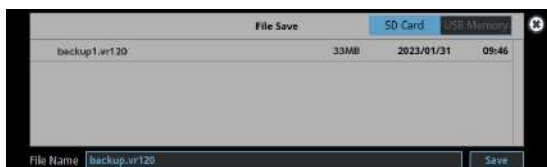

* Use the "SD Card" or "USB Memory" selector at the top right-hand corner of the screen to switch between the storage media to load from.

3. Select "File Name" and press the [VALUE] knob.

This brings up the software keyboard for input.

4. Input the backup file name.

* You can input up to 32 characters.

5. Touch <Enter> in software keyboard.



6. Use the [VALUE] knob to select "Save", and then press the [VALUE] knob.

A confirmation message appears.

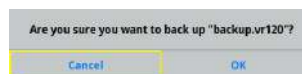

* If you decide to cancel, press the [EXIT] button.

7. Use the [VALUE] knob to select "OK", and then press the [VALUE] knob.

The settings file (.VR120) is backed up on the storage. When the operation is finished, the message "Completed" appears.

8. Press the [MENU] button to close the menu.

MEMO

Some settings are not saved to the file, such as the "Test Pattern" and "Test Tone" settings in the System menu.

Overwrite-saving

1. Insert the SD card into the SDXC card slot.

* When using a USB flash drive, connect the USB flash drive to the USB HOST port.

2. [MENU] button → “SD Card/USB Memory” → select “Backup All Settings”, and press the [VALUE] knob.

The backup files in the storage are listed.

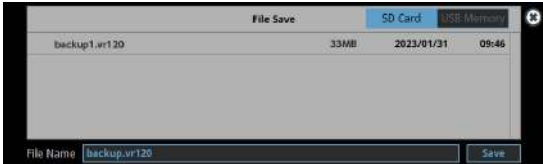

* Use the “SD Card” or “USB Memory” selector at the top right-hand corner of the screen to switch between the storage media to load from.

3. Touch the backup file that you want to overwrite.

The filename shown in the list of filenames is used.

4. Use the [VALUE] knob to select “Save”, and then press the [VALUE] knob.

A confirmation message appears.

* If you decide to cancel, press the [EXIT] button.

5. Use the [VALUE] knob to select “OK”, and then press the [VALUE] knob.

The settings file is overwrite-saved. When the operation is finished, the message “Completed” appears.

6. Press the [MENU] button to close the menu.

MEMO

Some settings are not saved to the file, such as the “Test Pattern” and “Test Tone” settings in the System menu.

Restoring

Here’s how to restore this unit’s settings that you saved on a storage. When you restore settings, the current settings are overwritten.

1. [MENU] button → “SD Card/USB Memory” → select “Restore All Settings”, and press the [VALUE] knob.



The backup files in the storage are listed.



* Use the “SD Card” or “USB Memory” selector at the top right-hand corner of the screen to switch between the storage media to load from.

2. Touch the settings file that you want to restore.

A confirmation message appears.

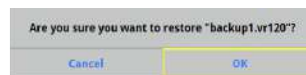

* If you decide to cancel, press the [EXIT] button.

3. Use the [VALUE] knob to select “OK”, and then press the [VALUE] knob.

The settings are restored. When the operation is finished, the message “Completed” appears.

Assigning Functions to the USER Buttons

You can assign the functions you want to the USER [1]–[4] buttons. By doing this, the function you assigned is executed when you press a USER button.

The functions printed on the operation panel are assigned to the USER buttons by factory default.

1. Press the USER [SETUP] button.
The User Assign screen appears.
2. Select the function by touching the “Category” and “Value” of the USER button you want to reassign.



* For details on the menu, refer to “27: System” (p. 162).

3. Press the lit [SETUP] button to close the setup screen.

Controlling an External Recorder’s Video Record Start/Stop from the VR-120HD

Connect a recorder that supports REC control functionality via HDMI to control rec start/stop on the recorder from the VR-120HD (REC control function).

For more about recorders that support the REC control function, refer to the Roland website.

<https://proav.roland.com/>

Setting

Assigning a USER button

To use the external REC control function, you must assign the recorder’s video recording start/stop functions to a USER button.

1. Assign the “External Rec Control” function to a USER button by following the steps in “Assigning Functions to the USER Buttons” (p. 97).

Turning REC control on/off

2. [MENU] button → “Video Output” → “HDMI Out 1–3” → and set “External Rec Control” to “ON”.



Operation

1. Press the USER button to which Rec Start/Stop is assigned.

Each time you press the button, the recorder switches between video record start/stop.

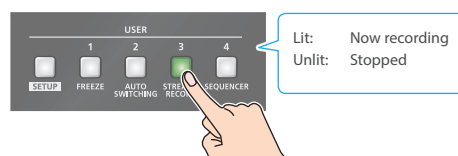

* This example shows the function assigned to the USER [3] button.

NOTE

The lights of the USER buttons show the status of the VR-120HD, and are not linked with the recorder’s status.

For instance, if the recorder stops recording for some reason while the USER button are lit, these buttons do not automatically go dark in response.

Remotely Controlling a PTZ Camera

You can connect up to twelve cameras via the DIRECT STREAM port and remotely control them from the VR-120HD.

This allows you to control cameras made by JVC, Panasonic, Canon, PTZOptics, and Avonic, and cameras that support VISCA over IP (such as Sony).

* Refer also to the owner's manual of your camera.

Network Settings on the Camera

In order to control a camera from the VR-120HD, you need to make network settings on the camera. You can register up to twelve cameras.

Assigning a USER button

To use the camera control function, you must assign the camera control function to a USER button.

1. Assign the "Camera Control" function to a USER button by following the steps in "Assigning Functions to the USER Buttons" (p. 97).

Network settings for the camera

2. Press the USER [SETUP] button.
The User Assign screen appears.
3. Touch <Setup> for the USER button to which you assigned the camera control function.

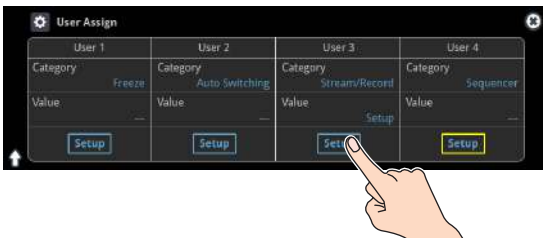

The camera control setup screen appears.

4. Touch the screen to configure the camera's network settings.



Menu item	Explanation
Camera ID	Selects the camera to be controlled.
Protocol	Specifies the camera's protocol.
IP Address	Input the camera's IP address.
Login Name	When "Protocol" is "JVC" Touch <Login Name> to bring up the software keyboard for input, and enter the log-in name needed to connect with the camera.
Password	When "Protocol" is "JVC" Touch <Password> to bring up the software keyboard for input, and enter the password needed to connect with the camera.

5. Press the lit [SETUP] button to close the setup screen.

Registering Camera Settings in a Preset

Up to 8 sets of settings such as camera position and focus can be registered as presets.

A registered preset can be recalled when needed.

* Presets are saved in the camera itself.

1. In step 2 of "Network Settings on the Camera", bring up the camera control setup screen.
2. Touch the screen to operate the camera settings.



Menu item	Explanation
Positioner	Adjusts the horizontal/ vertical position. Drag on the screen to operate the camera.
Pan Tilt Speed	Adjusts the speed at which the camera changes direction.
Zoom	Adjusts the zoom position. (*1)
Focus	Adjusts the focal point. (*1)
Auto Focus	When this is "ON", the focal point is set automatically.
Auto Exposure	Turns the camera auto-exposure on/off.
Tally Channel	Specifies the connector from which the camera video is input. When the camera video from the VR-120HD is the final output, the camera's tally light is lit.

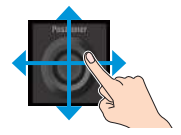

(*1) You can operate the camera while touching the screen.

3. Touch <Store>.
4. Touch the preset number (Camera Preset 1-8) area where you want to register the settings.



5. Press the lit [SETUP] button to close the setup screen.

Recalling a Preset

This shows you how to recall the presets registered in your camera. You can also recall presets from multiple cameras at the same time.

1. In step 3 of “Network Settings on the Camera”, bring up the camera control setup screen.

Recalling presets from a single camera

Menu item	Explanation
Camera ID	Select the camera from which you want to recall a preset.
All Cameras Load	Turns “All Cameras Load” off.



Recalling from all cameras simultaneously

Menu item	Explanation
All Cameras Load	Turns “All Cameras Load” on.



2. Touch the preset number (Camera Preset 1–8) area you want to recall.

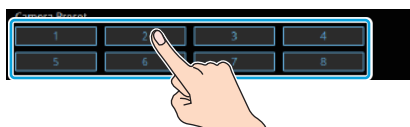

3. Press the lit [SETUP] button to close the setup screen.

Recalling presets with the buttons

By assigning a USER button to the camera control function, you can recall presets using the button.

To use the camera control function, you must assign the camera control function to a USER button.

Assigning a USER button

1. Assign the “Camera Control” function to a USER button by following the steps in “Assigning Functions to the USER Buttons” (p. 97).

Recalling a preset

2. On the camera control setup screen, set “All Cameras Load” to on (all cameras) or off (a single camera).
3. Press the USER button to which you’ve assigned the camera control function to turn camera control on (the button lights up).

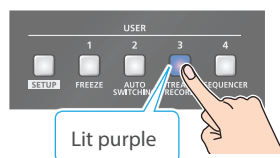

* This example shows the function assigned to the USER [3] button.

4. Touch <◀> or <▶> to change the “Camera ID”, and select the camera (1–12) for which you want to recall the preset.

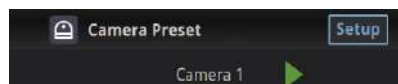

5. Press the VIDEO SWITCHER button for the preset number whose setting you want to recall.

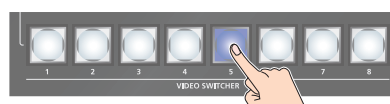

The settings are recalled from the cameras.

6. Press the USER button again to turn the camera control function off.

Using an Expression Pedal

You can use an expression pedal connected to the CTL/EXP 1 and 2 jacks to control the VR-120HD with your foot.

Adjusting the Pedal (Pedal Calibration)

The first time you use an expression pedal, you must calibrate (adjust) the pedal so that it will operate optimally.

In some cases, an expression pedal might no longer operate optimally due to the passage of time or changes in the operating conditions. If you notice problems such as slight movements of the pedal causing a major change in volume, or if the video fails to switch when you press the pedal, you should execute calibration.

1. [MENU] button → “Ctl/Exp” → “Ctl/Exp 1” Or “Ctl/Exp 2” → select “Ctl/Exp Type”, and press the [VALUE] knob.



2. Set the connected device to “Exp” (the expression pedal) using the [VALUE] knob, and press the [VALUE] knob.
3. Use the [VALUE] knob to select “Exp Calibration”, and press the [VALUE] knob.

The Exp Calibration screen appears.

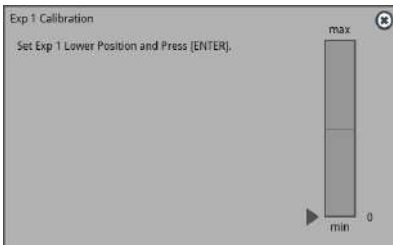

4. As directed by the screen, step on the pedal in the fully heel-down position, and press the [VALUE] knob.
5. As directed by the screen, step on the pedal in the fully toe-down position, and press the [VALUE] knob.
When the “Completed” indication appears, calibration is completed.
6. Press the [MENU] button to close the menu.

MEMO

You should normally use the EV-5 with its minimum volume knob left in the zero position. If you change the position of the minimum volume knob, you must execute pedal calibration.

Assigning a Function to the Pedal

You can assign various functions to the expression pedal.

1. [MENU] button → “Ctl/Exp” → “Ctl/Exp 1” Or “Ctl/Exp 2” → select “Ctl/Exp Type”, and press the [VALUE] knob.

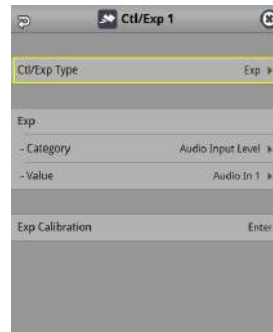

2. Set the connected device to “Exp” (the expression pedal) using the [VALUE] knob, and press the [VALUE] knob.
3. Use the [VALUE] knob to select Exp “Category” and “Value”, and press the [VALUE] knob.
4. Use the [VALUE] knob to select the function that you want to assign to the expression pedal, and press the [VALUE] knob.
* For details on the menu, refer to “22: Ctl/Exp” (p. 154).
5. Press the [MENU] button to close the menu.

Using a Footswitch

You can use a footswitch connected to the CTL/EXP 1 and 2 jacks to control the VR-120HD with your foot. You can assign various functions to the footswitch.

1. [MENU] button → “Ctl/Exp” → “Ctl/Exp 1” or “Ctl/Exp 2” → select “Ctl/Exp Type”, and press the [VALUE] knob.



2. Set the connected device to “Ctl A & Ctl B” (the footswitch) using the [VALUE] knob, and press the [VALUE] knob.
3. Use the [VALUE] knob to select Ctl A Or Ctl B “Category” and “Value”, and press the [VALUE] knob.
4. Use the [VALUE] knob to select the function that you want to assign to Ctl A or Ctl B of the footswitch, and press the [VALUE] knob.

* For details on the menu, refer to “22: Ctl/Exp” (p. 154).

5. Press the [MENU] button to close the menu.

MEMO

- See “Connecting a Footswitch” (p. 9) for how to connect a footswitch to this unit.
- If a single-pedal type footswitch such as the BOSS FS-5U is connected using a phone cable (mono), the function assigned by “Ctl B” is enabled.

Control Using the USB Numeric Keypad

You can connect a USB numeric keypad to the USB HOST port to control video transitions and perform other operations.

When you press a USB numeric keypad, the functions assigned to Keypad 0–Enter are executed.

NOTE

To control using a USB numeric keypad, make sure that Numlock is activated on the USB numeric keypad.

1. [MENU] button → “RS-232/Tally/GPO/GPI/Keypad” → “GPI” → select Keypad 0–Enter “CATEGORY” and “VALUE”, and press the [VALUE] knob.

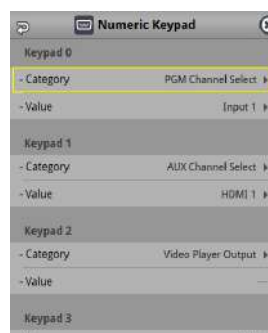

2. Use the [VALUE] knob to select the functions assigned to Keypad 0–Enter, and then press [VALUE].

* For details on the menu, refer to “23: RS-232/Tally/GPO/GPI/Keypad” (p. 156).

3. Press the [MENU] button to close the menu.

Control Using the TALLY/GPIO Connector

You can use control signals inputted to the TALLY/GPIO connector via GPI to remotely control the VR-120HD from an external device. Also, you can output tally signals or GPO control signals from the TALLY/GPIO connector.

Specification of the TALLY/GPIO Connector

Pin layout

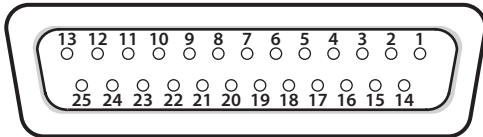

DB-25 type (female)

Tally output

Trigger method	Open collector
Maximum input	12 V/120 mA

Control input

Trigger method	No-voltage contact (make-contact) triggering
Contact capacity	DC 24 V 0.1 A or higher
Input method	Photocoupler

Pin assignments

Pin no.	Pin name	Function (default value)
1	TALLY/GPO 1	PGM HDMI 1
2	TALLY/GPO 2	PST HDMI 1
3	TALLY/GPO 3	PGM HDMI 2
4	TALLY/GPO 4	PST HDMI 2
5	TALLY/GPO 5	PGM HDMI 3
6	TALLY/GPO 6	PST HDMI 3
7	TALLY/GPO 7	PGM HDMI 4
8	TALLY/GPO 8	PST HDMI 4
9	TALLY/GPO 9	PGM HDMI 5
10	TALLY/GPO 10	PST HDMI 5
11	TALLY/GPO 11	PGM HDMI 6
12	TALLY/GPO 12	PST HDMI 6
13	TALLY/GPO 13	GPO 1
14	TALLY/GPO 14	GPO 2
15	TALLY/GPO 15	GPO 3
16	TALLY/GPO 16	GPO 4
17	GND	
18	GPI 1	Not assigned
19	GPI 2	Not assigned
20	GPI 3	Not assigned
21	GPI 4	Not assigned
22	GPI 5	Not assigned
23	GPI 6	Not assigned
24	GPI 7	Not assigned
25	GPI 8	Not assigned

Inputting a Control Signal

When an external control signal is input, the functions assigned to GPI 1–8 are executed.

1. [MENU] button → “RS-232/Tally/GPO/GPI/Keypad” → “GPI” → select GPI 1–8 “Category” and “Value”, and press the [VALUE] knob.
2. Use the [VALUE] knob to select the functions assigned to GPI 1–8, and then press [VALUE].



* For details on the menu, refer to “23: RS-232/Tally/GPO/GPI/Keypad” (p. 156).

3. Press the [MENU] button to close the menu.

Outputting a Tally Signal

Pins 1–16 of the TALLY/GPIO connector can be used to output a tally. A tally signal is output from the connector pins whenever a VIDEO SWITCHER button is selected.

1. [MENU] button → “RS-232/Tally/GPO/GPI/Keypad” → “Tally/GPO” → select “Tally/GPO 1”–“Tally/GPO 16”, and press the [VALUE] knob.



2. Use the [VALUE] knob to select the tally signal assigned to the connector pins and then press the [VALUE] knob.

Value	Explanation
PGM HDMI 1–6	Video for which the final output is HDMI IN 1–6.
PGM SDI 1–6	Video for which the final output is SDI IN 1–6.
PGM Still 1–16	The final output is still images 1–16.
PGM Video Player/SRT In	The final output is the video from the video player/SRT input.
PGM Input 1–8	Use the VIDEO SWITCHER [1]–[8] buttons to select the final output video.
PST HDMI 1–6	Video for which the preview output is HDMI IN 1–6.
PST SDI 1–6	Video for which the preview output is SDI IN 1–6.
PST Still 1–16	The preview output is still images 1–16.
PST Video Player/SRT In	The preview output is the video from the video player/SRT input.
PST Input 1–8	Use the VIDEO SWITCHER [1]–[8] buttons to select the preview output video.

3. Press the [MENU] button to close the menu.

MEMO

- Use a settings template to change the assignments for the connector pins all at once.
Select a template from “Template” in the Tally/GPO menu and then press the [VALUE] knob to apply the settings.
- You can reflect the PinP&Key, DSK, and AUX bus video output status in the tally information.
When you set each “Tally Settings” item in the Tally/GPO menu to “Enable”, the status of video output to the relevant bus is reflected in the tally information (p. 156).

Outputting a Control Signal

You can use connector pins 1–16 of the TALLY/GPIO connector as GPOs to output control signals.

Assigning the GPOs

You can assign pins 1–16 of the TALLY/GPIO connector to the GPOs (1–16) in order to output control signals.

1. [MENU] button → “RS-232/Tally/GPO/GPI/Keypad” → “Tally/GPO” → select “Tally/GPO 1”–“Tally/GPO 16”, and press the [VALUE] knob.

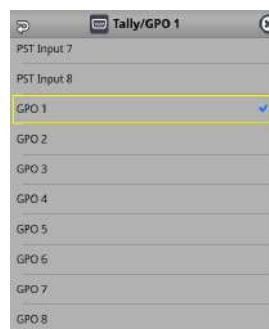

2. Use the [VALUE] knob to select one of “GPO 1”–“GPO 16”, and press the [VALUE] knob.
3. Press the [MENU] button to close the menu.

MEMO

Use a settings template to change the assignments for the connector pins all at once.
Select a template from “Template” in the Tally/GPO menu and then press the [VALUE] knob to apply the settings.

Outputting a control signal

Control signals are outputted when you operate a USER button, footswitch or other control to which a GPO output function has been assigned.

Using the USER buttons

The USER buttons light up while control signals are being output.

➔ “Assigning Functions to the USER Buttons” (p. 97)

Using a footswitch

➔ “Using a Footswitch” (p. 101)

Inputting an external control signal (GPI)

➔ “Inputting a Control Signal” (p. 102)

Using Smart Tally

Roland's own Smart Tally system turns your smart device or computer that's connected to the VR-120HD into a tally box. This lets you access your smart device or computer via a wireless LAN access point to display a tally on that device.

Connecting via a Wireless LAN Router

Connect your Wi-Fi enabled smart device or computer to the wireless LAN router via Wi-Fi.

* If you connect multiple smart devices or computers, operation might be slower.

1. Use a LAN cable to connect the LAN port on your wireless LAN master device to the DIRECT STREAM port on the VR-120HD.

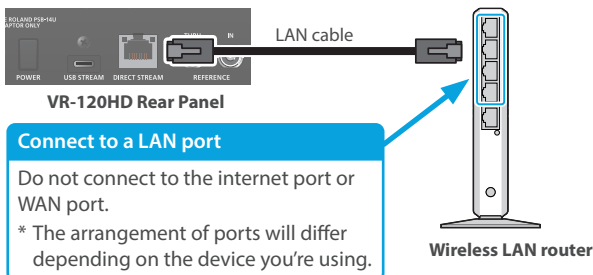

2. Turn on the wireless LAN master device, and connect your smart device or computer via wireless LAN (Wi-Fi).

Enable the DHCP function of the wireless LAN router.

* For details on how to connect the wireless LAN (Wi-Fi), refer to the manual of the device that you're using.

3. Power-on the VR-120HD.

4. [MENU] button → "Network" → "LAN Setup" → set "Configure" to "Using DHCP", and press the [VALUE] knob.

The IP address, subnet mask, and default gateway are obtained automatically.



5. Use the [VALUE] knob to select "Apply", and press the [VALUE] knob.

6. Use the [VALUE] knob to select "Network Information", and press the [VALUE] knob.

* Network Information screen appears.

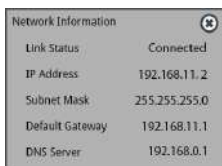

When "Link Status" indicates "Connected", the connection settings are complete.

MEMO

If you fix the IP address, you'll always be able to start Smart Tally with the same IP address.

For details on how to specify a fixed IP address, refer to the manual of the wireless LAN router that you're using.

Starting Smart Tally

1. From the VR-120HD's [MENU] button → "Network" → select "Network Information", and press the [VALUE] knob.

The Network Information screen appears.

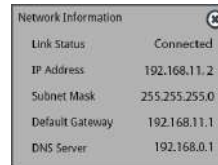

2. Start a browser on your smart device or computer.

3. In the URL input field of your browser, enter the IP address that's shown in the Network Information screen to access the website.

The Smart Tally settings screen appears.

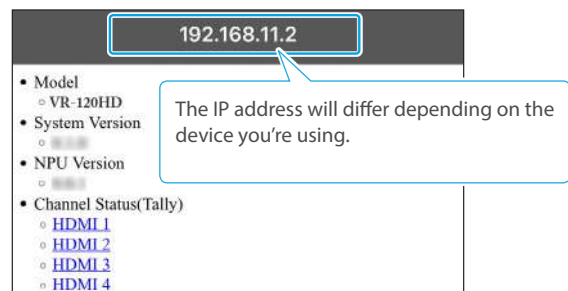

* You can also access the website by scanning a QR code. The QR code is shown when you press "2D Code for Smart Tally" on the screen in step 1.

4. In "Channel Status (Tally)", select the video source that you want to assign to the smart device or computer.

The device's display switches to the tally information screen.

This shows the tally information corresponding to the video source output from the VR-120HD.



Red: PGM



Green: PST



Gray: Not selected

NOTE

- Depending on the network conditions, the wireless LAN (Wi-Fi) communication speed or connection might be unstable, so that the tally indication is not displayed correctly. In this case, reload the page.
- Depending on the version of the browser that you're using, the tally indication might not be displayed correctly. Use the latest version of the browser whenever possible.

Preventing Unintended Operation (Panel Lock)

You can disable operation of the panel's buttons and knobs to prevent unintended operations (Panel Lock function).

1. [MENU] button → "System" → select "Panel Lock", and press the [VALUE] knob.

The Panel Lock menu appears.

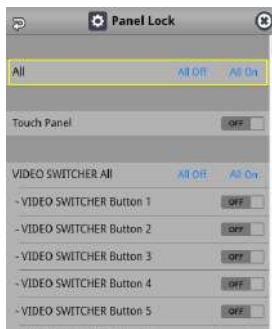

2. Use the [VALUE] knob to select a target for panel lock, and press the [VALUE] knob.

Menu item	Explanation
All	The following settings are turned on/off together.
Touch Screen	Touch panel operation
VIDEO SWITCHER All	Buttons in VIDEO section
VIDEO SWITCHER 1-8 Button	VIDEO SWITCHER [1]-[8] buttons
CUT Button	[CUT] button
AUTO Button	[AUTO] button
MODE All	Buttons in MODE section
SETUP Button	MODE [SETUP] button
INPUT SELECT Button	[INPUT SELECT] button
AUX Button	[AUX] button
SCENE MEMORY Button	[SCENE MEMORY] button
MACRO Button	[MACRO] button
TRANSITION All	Buttons in TRANSITION section
SETUP Button	TRANSITION [SETUP] button
MIX Button	[MIX] button
WIPE Button	[WIPE] button
SPLIT 1 Button	[SPLIT 1] button
SPLIT 2 Button	[SPLIT 2] button
PinP&KEY 1-4 All	Buttons in PinP&KEY 1-4 section
SETUP Button	PinP&KEY 1-4 [SETUP] button
PVW Button	PinP&KEY 1-4 [PVW] button
PGM Button	PinP&KEY 1-4 [PGM] button
DSK 1-2 All	Buttons in DSK1-2 section
SETUP Button	DSK1-2 [SETUP] button
PVW Button	DSK1-2 [PVW] button
PGM Button	DSK1-2 [PGM] button
USER Button All	Buttons in USER section
SETUP Button	USER [SETUP] button
USER 1-4 Button	USER [1]-[4] button
MONITOR Button All	Buttons in MONITOR section
SETUP Button	MONITOR [SETUP] button
MONITOR 1-4 Button	MONITOR [1]-[4] button
CAPTURE IMAGE Button	[CAPTURE IMAGE] button
AUDIO LEVEL Button	[AUDIO LEVEL] button
OUTPUT FADE Button	[OUTPUT FADE] button

Menu item	Explanation
AUDIO MIXER 1-9/10 All	Buttons and knobs in AUDIO INPUT section
GAIN 1-9/10 Knob	GAIN [1]-[9/10] knob
SETUP 1-9/10 Button	SETUP [1]-[9/10] buttons
SOLO 1-9/10 Button	SOLO [1]-[9/10] buttons
MUTE 1-9/10 Button	MUTE [1]-[9/10] buttons
Level 1-9/10 Fader	Level [1]-[9/10] fader
MAIN All	Buttons and knobs in AUDIO OUTPUT section
SETUP Button	MAIN [SETUP] button
SOLO Button	MAIN [SOLO] button
MUTE Button	MAIN [MUTE] button
Level Fader	MAIN [Level] fader
AUX 1 Knob	[AUX 1] knob
AUX 2 Knob	[AUX 2] knob
USB OUT Knob	[USB OUT] knob
STREAM/RECORD Knob	[STREAM/RECORD] knob
AUDIO EFFECT All	Buttons in AUDIO EFFECT section
SETUP Button	AUDIO EFFECT [SETUP] button
AUDIO EFFECT 1-4 Button	AUDIO EFFECT [1]-[4] button
AUDIO PLAYER All	Buttons in AUDIO PLAYER section
SETUP Button	AUDIO PLAYER [SETUP] button
AUDIO PLAYER 1-8 Pad	AUDIO PLAYER [1]-[8] pads
Level Knob	AUDIO PLAYER [LEVEL] knob

3. Use the [VALUE] knob to specify whether panel lock is enable (ON) or disable (OFF), and press the [VALUE] knob.
4. Press the [MENU] button to close the menu.

MEMO

The [MENU] button blinks when you try to operate a locked button, knob or other control.

Remotely Controlling the VR-120HD

To remotely control the VR-120HD, you can use an external device to send control signals to the unit (p. 102), use a dedicated app, or use LAN/RS-232 commands.

Using the dedicated apps “VR-120HD RCS” and “VR-120HD Remote”

Dedicated apps are available for computers (“VR-120HD RCS”) and for the iPad (“VR-120HD Remote”).

These apps can be downloaded from the Roland website.

<https://proav.roland.com/>

* For operating details, refer to the VR-120HD RCS or VR-120HD Remote connection guide.

VR-120HD RCS (Windows/Mac)

Use the dedicated “VR-120HD RCS” app to operate the VR-120HD from your computer.

You can connect either wirelessly or via cable.

Wireless connection

- Connection via wireless LAN master device (Wi-Fi)

Wired connection (via cable)

- USB connection (USB Type-C cable)
- LAN connection (LAN cable)
- RS-232 connection (RS-232 cable)

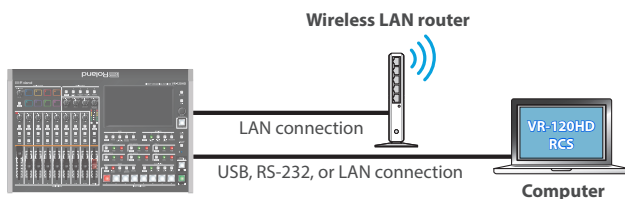

VR-120HD Remote

Use the dedicated “VR-120HD Remote” app to operate the VR-120HD from your iPad.

You can connect either wirelessly or via cable.

Wireless connection

- Bluetooth connection
- Connection via wireless LAN master device (Wi-Fi)

Wired connection (via cable)

USB connection (USB Type-C cable, Lightning to USB camera adapter)

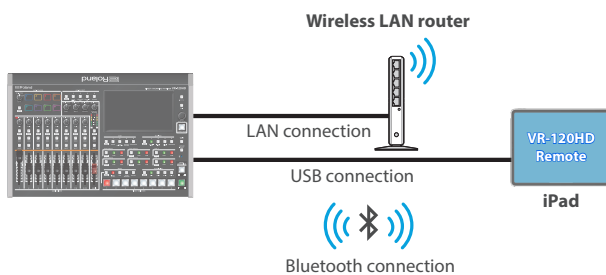

LAN/RS-232 command

The VR-120HD support two types of remote-interface communication: LAN and RS-232.

Using the DIRECT STREAM port or RS-232 connector to send specific commands to the VR-120HD from a controlling device lets you operate the VR-120HD.

See “Remote Control Guide” (Roland website) for details on each interface and for a list of LAN/RS-232 commands.

<https://roland.cm/vr-120hd>

MEMO

MIDI implementation

The VR-120HD supports MIDI remote control.

See “MIDI Implementation” in the “Remote Control Guide” (Roland website) for details.

Returning to the Factory Settings (Factory Reset)

Here's how you can return the settings of the VR-120HD to their factory-set state.

If following the procedures described in this manual does not cause the result you expect, try executing a factory reset.

NOTE

- When you execute a factory reset, all the settings you've made as well as the data saved on the VR-120HD (preset memory, macros, sequencer, and still images) is lost.
- Do not turn off the power while the message "Processing..." is shown.

1. [MENU] button → "System" → select "Factory Reset", and press the [VALUE] knob.

A confirmation message appears.

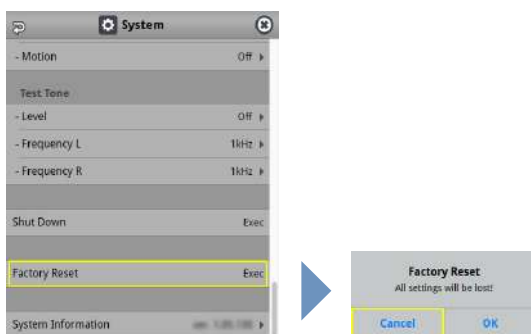

* If you decide to cancel, press the [EXIT] button.

2. Use the [VALUE] knob to select "OK", and then press the [VALUE] knob.

Factory reset is executed. When the operation is finished, the message "Completed" appears.

Menu List

1: Video Assign

Menu item	Value (bold text: default value)	Explanation
Jump To Setup	Enter	Jumps to the setup screen.
Input 1–8	HDMI 1–6, SDI 1–6, Still 1–16, V.Player/SRT In (*1), Stream/Record Status 1–2, Date&Time (Analog/Digital) (*2), N/A The default values are as follows. Input 1: HDMI 1 Input 2: HDMI 2 Input 3: HDMI 3 Input 4: HDMI 4 Input 5: HDMI 5 Input 6: HDMI 6 Input 7: Still 1 Input 8: Still 2	Sets the video source (input video and still images) to assign to the VIDEO SWITCHER [1]–[8] buttons.
HDMI Out 1–3	Specifies the video bus that is assigned to the HDMI OUT 1–3 connectors.	
	Program	Final output video. This is the default setting for “HDMI Out 1”.
	Sub Program	Sub Program bus video
	Preview	Preview output video. This is the default setting for “HDMI Out 2”.
	AUX 1–3	AUX bus video
	DSK 1 Source	DSK video source
	DSK 2 Source	
	Multi-View	Multi-view. This is the default setting for “HDMI Out 3”.
	Input-View	The input video from the HDMI IN and SDI IN connectors (shown as 16 separate sections on the screen)
Still-View	Still images loaded into the unit (shown as 16 separate sections on the screen)	
SDI Out 1–3	Specifies the video bus that is assigned to the SDI OUT 1–3 connectors.	
	Program	Final output video. This is the default setting for “SDI Out 1”.
	Sub Program	SUB PROGRAM bus video
	Preview	Preview output video. This is the default setting for “SDI Out 2”.
	AUX 1–3	AUX bus video
	DSK 1 Source	DSK video source
	DSK 2 Source	
	Multi-View	Multi-view. This is the default setting for “SDI Out 3”.
	Input-View	The input video from the HDMI IN and SDI IN connectors (shown as 16 separate sections on the screen)
Still-View	Still images loaded into the unit (shown as 16 separate sections on the screen)	
USB Out	Specifies the video bus that is assigned to the USB STREAM port.	
	Program	Final output video.
	Sub Program	SUB PROGRAM bus video
	Preview	Preview output video.
	AUX 1–3	AUX bus video
	DSK 1 Source	DSK video source
	DSK 2 Source	
	Multi-View	Multi-view.
	Input-View	The input video from the HDMI IN and SDI IN connectors (shown as 16 separate sections on the screen)
Still-View	Still images loaded into the unit (shown as 16 separate sections on the screen)	

(*1) Depending on the “Video Player/SRT In” → “Type” setting, either V.Player or SRT in is displayed.

(*2) The analog/digital display changes in the “System → Date&Time → Clock Display Type” setting.

Menu item	Value (bold text: default value)	Explanation
Stream/Record	Specifies the video bus that is assigned to the DIRECT STREAM port.	
	Program	Final output video.
	Sub Program	SUB PROGRAM bus video
	Preview	Preview output video.
	AUX 1-3	AUX bus video
	DSK 1 Source	DSK video source
	DSK 2 Source	
	Multi-View	Multi-view.
	Input-View	The input video from the HDMI IN and SDI IN connectors (shown as 16 separate sections on the screen)
Still-View	Still images loaded into the unit (shown as 16 separate sections on the screen)	
LCD Monitor	Specifies the video bus to which this unit's display is assigned.	
	Program	Final output video.
	Sub Program	SUB PROGRAM bus video
	Preview	Preview output video.
	AUX 1-3	AUX bus video
	DSK 1 Source	DSK video source
	DSK 2 Source	
	Multi-View	Multi-view.
	Input-View	The input video from the HDMI IN and SDI IN connectors (shown as 16 separate sections on the screen)
Still-View	Still images loaded into the unit (shown as 16 separate sections on the screen)	
Program Layer	Enter	
	Displays the Program Layer menu.	
	Menu item	Value
	Explanation	
Program Layer	Jump To Setup	Enter
	PinP & KEY 1-4	Disable, Enable
	DSK 1, 2	Disable, Enable
		Jumps to the setup screen.
		Sets whether each layer is displayed (Enable) or hidden (Disable) in the final output video.
Sub Program Layer	Enter	
	Displays the Sub Program Layer menu.	
	Menu item	Value
	Explanation	
Sub Program Layer	Jump To Setup	Enter
	PinP & KEY 1-4	Disable, Enable
	DSK 1, 2	Disable, Enable
		Jumps to the setup screen.
		Sets whether each layer is displayed (Enable) or hidden (Disable) in the Sub Program bus video.
AUX	Menu item	Value
	Explanation	
AUX	Jump To Setup	Enter
	Jumps to the setup screen.	
AUX 1-3 Source	HDMI 1-6, SDI 1-6, Still 1-16, V.Player/SRT In (*3), Input 1-8	Selects the video that is sent to the AUX bus. When "AUX" is selected on the [MODE] button, you can use the VIDEO SWITCHER [1]-[8] buttons to select the video that is sent to the AUX bus.
AUX 1-3 Layer	Enter	
	Displays the AUX Layer menu.	
	Menu item	Value
	Explanation	
AUX 1-3 Layer	Jump To Setup	Enter
	PinP & KEY 1-4	Disable , Enable, Always On
	DSK 1, 2	Disable , Enable, Always On
		Jumps to the setup screen.
		Sets each layer to be shown (Enable), hidden (Disable) or always shown (Always On) for the AUX bus video.

(*3) Depending on the "Video Player/SRT In" → "Type" setting, either V.Player or SRT in is displayed.

2: Video Input

Menu item	Value (bold text: default value)	Explanation
HDMI In 1-6 (Scaler) (*3)	Adjusts the video that is input from the HDMI IN 1-6 connectors.	
Input Status (*5)	Enter	Displays information about the incoming video (format, size, etc.).
Test Pattern (*5)	Off , Color Bars 75%, Color Bars 100%, Ramp, Step, Hatch, Diamond, Circle, Color Bars 75%-SP, Color Bars 100%-SP, Ramp-SP, Step-SP, Hatch-SP	Selects the test pattern to display.
Color Space (*5)	Auto , RGB (0-255), RGB (16-235), YPbPr (SD), YPbPr (HD)	Specifies the color space.
Flicker Filter (*5)	OFF , ON	When this is "ON", flickering is reduced.
Flip H (*5)	OFF , ON	When this is "ON", the video is input with left and right flipped.
Flip V (*5)	OFF , ON	When this is "ON", the video is input with top and bottom flipped.
EDID (*5)	Internal SVGA (800 x 600) XGA (1024 x 768) WXGA (1280 x 800) FWXGA (1366 x 768) SXGA (1280 x 1024) SXGA+ (1400 x 1050) UXGA (1600 x 1200) WUXGA (1920 x 1200) 720p, 1080i, 1080p	Specifies the input format (EDID). When this is "INTERNAL", EDID information for all formats that can be input to the VR-120HD will be transmitted. What is EDID? EDID is data that is transmitted from the VR-120HD to the source device when the VR-120HD is connected to a source device. EDID contains data such as the formats that can be input to the VR-120HD (resolution, color space, color depth) and audio information. Based on the EDID information that the source device receives, it will output the most appropriate video format to the VR-120HD.
Zoom (*5)	10.0- 100.0 -1000.0% (*6)	Adjusts the zoom ratio.
Scaling Type (*5)	Specifies the scaling type.	
	Full	Always displays the picture expanded to full screen, irrespective of the aspect ratio of the input video.
	Letterbox	Enlarges or reduces the incoming video to a full-screen view while keeping the aspect ratio unchanged.
	Crop	Enlarges or reduces the incoming video so that the output picture has no blank margins while keeping the aspect ratio unchanged. Video extending beyond the borders is cut off.
	Dot By Dot	Performs no scaling.
	Manual	Scale according to the "Manual Size H" and "Manual Size V" settings below.
Manual Size H (*5, *7)	-2000- 0 -2000 (*6)	Adjusts the horizontal size.
Manual Size V (*5, *7)	-2000- 0 -2000 (*6)	Adjusts the vertical size.
Position H (*5)	-1920- 0 -1920	Adjusts the position in the horizontal direction.
Position V (*5)	-1200- 0 -1200	Adjusts the position in the vertical direction.
Brightness (*5)	-32- 0 -31	Adjusts the brightness.
Contrast (*5)	-32- 0 -31	Adjusts the contrast.
Saturation (*5)	-32- 0 -31	Adjusts the saturation.
Red (*5)	-64- 0 -63	Adjusts the red level.
Green (*5)	-64- 0 -63	Adjusts the green level.
Blue (*5)	-64- 0 -63	Adjusts the blue level.
SDI In 1-6	Adjusts the video that is input from the SDI IN 1-6 connectors.	
Input Status	Enter	Displays information about the incoming video (format, size, etc.).
Flip H	OFF , ON	When this is "ON", the video is input with left and right flipped.
Flip V	OFF , ON	When this is "ON", the video is input with top and bottom flipped.
Brightness	-32- 0 -31	Adjusts the brightness.
Contrast	-32- 0 -31	Adjusts the contrast.
Saturation	-32- 0 -31	Adjusts the saturation.
Video Player/SRT In	Adjusts the video that is input from the video player/SRT input.	
Flip H	OFF , ON	When this is "ON", the video is input with left and right flipped.
Flip V	OFF , ON	When this is "ON", the video is input with top and bottom flipped.

(*4) When Roland Fill+Key → Mode is set to "DSK 1" or "DSK 2", all other settings in HDMI in 6 (Scaler) besides Input Status are disabled.

(*5) When Test Pattern is set to a value besides "Off", the Input Status setting and the settings from Color Space through Blue are disabled.











(*6) The valid range of setting values depends on conditions such as the input/output format.

(*7) This can be set if "Scaling Type" is "Manual".

3: Video Output

Menu item	Value (bold text: default value)	Explanation
HDMI Out 1–3 Adjusts the video that is output from the HDMI OUT 1–3 connectors.		
Output Status	—	Shows the format and an HDCP signal presence. If there is no connection, "Not Connected" is shown.
Color Space	YPbPr (4: 4: 4) , YPbPr (4: 2: 2), RGB (0–255), RGB (16–235)	Specifies the color space.
DVI-D/HDMI Signal	HDMI , DVI-D	Specifies the type of output signal.
Brightness	-64– 0 –63	Adjusts the brightness.
Contrast	-64– 0 –63	Adjusts the contrast.
Saturation	-64– 0 –63	Adjusts the saturation.
Red	-64– 0 –63	Adjusts the red level.
Green	-64– 0 –63	Adjusts the green level.
Blue	-64– 0 –63	Adjusts the blue level.
External Rec Control	OFF, ON	Turns the External Rec control on/off. When this is "ON", REC START/STOP commands can be sent to a recorder that supports REC control functionality. To use the External Rec control function, the REC START/STOP functions must be assigned to the USER button. From the System menu → "User Assign" → "User 1"–"User 4" set "Category" to "External Rec Control".
SDI Out 1–3 Adjusts the video that is output from the SDI OUT 1–3 connectors.		
Output Status	—	Shows the format. * When "HDCP" in the SYSTEM menu is "ON", "HDCP MASKED" is displayed, and video/audio is not outputted from the SDI OUT connectors.
3G-SDI Mapping	Level-A, Level-B	Specifies the mapping structure of the 3G-SDI output.
Brightness	-64– 0 –63	Adjusts the brightness.
Contrast	-64– 0 –63	Adjusts the contrast.
Saturation	-64– 0 –63	Adjusts the saturation.
USB Out Adjusts the video that is output from the USB STREAM port. * You can edit the USB output video format and compression method from the livestreaming app or other app used at the output destination.		
Output Status	—	Indicates whether the connection uses USB 2.0 (HIGH SPEED) or USB 3.0 (SUPER SPEED). If not connected to a computer, this indicates "Not Connected". * When "HDCP" in the SYSTEM menu is "ON", "HDCP MASKED" is displayed, and video/audio is not outputted from the USB STREAM port.
Output Format	Sets the output destination formats that can be selected from the livestreaming app. YUY2 & MJPEG YUY2	YUY2 and Motion JPEG are selectable. Only YUY2 is selectable.
Connection Reset	Exec	Reconnects the computer and the VR-120HD when the video is garbled or when operation is otherwise unstable.

4: Transition

Menu item	Value (bold text: default value)	Explanation
Mix	These are the detailed mix settings.	
Jump To Setup	Enter	Jumps to the setup screen.
Mix Type	Specifies the transition pattern for mix.	
	Mix	The two videos are mixed as the transition occurs.
	FAM	Video transitions are made with the luminance levels of the two video streams maintained unchanged. This is an abbreviation of "full additive mix".
	NAM	The two video streams are compared, and transitions are made with display during transition starting with levels of high luminance. This is an abbreviation of "non-additive mix".
Mix Time	0.0– 1.0 –4.0sec	Specifies the video transition time.
Wipe	These are the detailed wipe settings.	
Jump To Setup	Enter	Jumps to the setup screen.
Wipe Type	Specifies the transition pattern for wipe.	
	<div style="display: flex; justify-content: space-around; align-items: flex-start;"> <div style="text-align: center;"> Horizontal  </div> <div style="text-align: center;"> Vertical  </div> <div style="text-align: center;"> Upper Left  </div> <div style="text-align: center;"> Upper Right  </div> <div style="text-align: center;"> Lower Left  </div> <div style="text-align: center;"> Lower Right  </div> <div style="text-align: center;"> H-Center  </div> <div style="text-align: center;"> V-Center  </div> </div>	
Wipe Time	0.0– 1.0 –4.0sec	Specifies the video transition time.
Direction	Normal , Reverse, Round Trip	Specifies the direction of wipe.
Border Color	White , Yellow, Cyan, Green, Magenta, Red, Blue, Black, Custom, Soft Edge	Specifies the color of the border added to the edge of the wipe area. When this is set to "Soft Edge", the wipe border is blurred.
	Edit	—
Border Width	0– 3 –14	Specifies the width of the border added to the edge of the wipe area.
Split 1, 2	These are the detailed settings for the split composite.	
Jump To Setup	Enter	Jumps to the setup screen.
Split Type	These parameters configure the split screen layout.	
	Split V	This vertically crops the center section of the video (split left/right). This is the default setting for "Split 1". 
	Split H	This horizontally crops the center section of the video (split upper/lower). This is the default setting for "Split 2". 
PGM Source	HDMI 1–6, SDI 1–6, Still 1–16, V.Player/SRT In (*8), Input 1–8	Selects the video source to display on the left or upper side.
PST Source	HDMI 1–6, SDI 1–6, Still 1–16, V.Player/SRT In (*8), Input 1, Input 2–8	Selects the video source to display on the left or upper side.
PGM Center	-50.0– 0.0 –50.0%	When at SPLIT V Adjusts the horizontal position of the video placed on the left. When at SPLIT H Adjusts the horizontal position of the video placed above. * This positions the PGM bus video to the left or upper side.
PST Center	-50.0– 0.0 –50.0%	When at SPLIT V Adjusts the horizontal position of the video placed on the right. When at SPLIT H Adjusts the horizontal position of the video placed below. * This positions the PST bus video to the right or lower side.
Center Position	-50.0– 0.0 –50.0%	Adjusts the position of the boundary.
Border Color	White , Yellow, Cyan, Green, Magenta, Red, Blue, Black, Custom	Specifies the color of the border.
	Edit	—
Border Width	0– 3 –14	Adjusts the width of the border.

(*8) Depending on the "Video Player/SRT In" → "Type" setting, either V.Player or SRT in is displayed.

5: PinP & Key

Menu item	Value (bold text: default value)	Explanation
PinP & Key 1-4	These are the detailed settings for PinP and key composition for each PinP and key layer.	
Jump To Setup	Enter	Jumps to the setup screen.
Type	Specifies the type of PinP compositing.	
	PinP	Composites the inset screen on top of the background video.
	Luminance-White Key	A combination of PinP and luminance key (white). Makes the white portions of the inset screen transparent, and composites the image with the background.
	Luminance-Black Key	A combination of PinP and luminance key (black). Makes the black portions of the inset screen transparent, and composites the image with the background.
	Chroma Key	A combination of PinP and chroma key. Makes the specified key color portions of the inset screen transparent, and composites the image with the background.
Source	HDMI 1-6 , SDI 1-6, Still 1-16, V.Player/SRT In (*9), Input 1-8	Specifies the video source of the inset screen.
Time	0.0- 1.0 -4.0sec	Specifies the video transition time.
When Type = PinP		
Window	Adjusts the inset screen.	
Position H	-50.0-- 40.0 -50.0%	Adjusts the horizontal position of the inset screen.
Position V	-50.0-- 40.0 -50.0%	Adjusts the vertical position of the inset screen.
Size	0.0- 35.0 -100.0%	Adjusts the size of the inset screen.
Cropping H	0.0- 100.0%	Adjusts the horizontal size of the inset screen.
Cropping V	0.0- 100.0%	Adjusts the vertical size of the inset screen.
Shape	Rectangle , Circle, Diamond	Specifies the shape of the inset screen.
Border Color	White , Yellow, Cyan, Green, Magenta, Red, Blue, Black, Custom, Soft Edge	Specifies the color of the border for the inset screen. When this is set to "Soft Edge", the edge of the inset screen is blurred.
Edit	—	When Border Color is "Custom", you can adjust the color of the border.
Border Width	0- 3 -14	Adjusts the width of the border for the inset screen.
View	Adjusts the video that is shown in the inset screen.	
Position H	-50.0- 0.0 -50.0%	Adjusts the horizontal position at which the inset screen is shown.
Position V	-50.0- 0.0 -50.0%	Adjusts the vertical position at which the inset screen is shown.
Zoom	100 -400%	Adjusts the zoom of the video shown in the inset screen.
When Type = Luminance-White Key or Luminance-Black Key		
Window	Adjusts the inset screen.	
Position H	-50.0-- 40.0 -50.0%	Adjusts the horizontal position of the inset screen.
Position V	-50.0-- 40.0 -50.0%	Adjusts the vertical position of the inset screen.
Size	0.0- 35.0 -100.0%	Adjusts the size of the inset screen.
Cropping H	0.0- 100.0%	Adjusts the horizontal size of the inset screen.
Cropping V	0.0- 100.0%	Adjusts the vertical size of the inset screen.
View	Adjusts the video that is shown in the inset screen.	
Position H	-50.0- 0.0 -50.0%	Adjusts the horizontal position at which the inset screen is shown.
Position V	-50.0- 0.0 -50.0%	Adjusts the vertical position at which the inset screen is shown.
Zoom	100 -400%	Adjusts the zoom of the video shown in the inset screen.
Key	Adjusts the key.	
Key Level	0- 64 -255	Adjusts the degree of extraction (transparency) for the key.
Key Gain	0 -255	Adjusts the degree of edge blur (semi-transmissive region) for the key.
Mix Level	0- 255	Adjusts the key's overall density (output level).

(*9) Depending on the "Video Player/SRT In" → "Type" setting, either V.Player or SRT in is displayed.

Menu List

Menu item	Value (bold text: default value)	Explanation
When Type = Chroma Key		
Window	Adjusts the inset screen.	
Position H	-50.0-- 40.0 -50.0%	Adjusts the horizontal position of the inset screen.
Position V	-50.0-- 40.0 -50.0%	Adjusts the vertical position of the inset screen.
Size	0.0- 35.0 -100.0%	Adjusts the size of the inset screen.
Cropping H	0.0- 100.0%	Adjusts the horizontal size of the inset screen.
Cropping V	0.0- 100.0%	Adjusts the vertical size of the inset screen.
View	Adjusts the video that is shown in the inset screen.	
Position H	-50.0- 0.0 -50.0%	Adjusts the horizontal position at which the inset screen is shown.
Position V	-50.0- 0.0 -50.0%	Adjusts the vertical position at which the inset screen is shown.
Zoom	100 -400%	Adjusts the zoom of the video shown in the inset screen.
Key	Adjusts the key.	
Key Level	0- 64 -255	Adjusts the degree of extraction (transparency) for the key.
Key Gain	0 -255	Adjusts the degree of edge blur (semi-transmissive region) for the key.
Mix Level	0- 255	Adjusts the key's overall density (output level).
Chroma	Make detailed settings for chroma key.	
Color	Green, Blue	Specifies green or blue as the key color (the color to be removed). If you want a color other than green or blue to turn transparent, use "Sampling Marker Mode" to specify the key color.
Hue Width	-30- 0 -30	Adjusts the hue width for the key color.
Hue Fine	0- 240 -360	Adjusts the center position of the hue for the key color.
Saturation Width	-128- 0 -127	Adjusts the saturation width for the key color.
Saturation Fine	0 -255	Adjusts the center position of saturation for the key color.
Value Width	-128- 0 -127	Adjusts the brightness width for the key color.
Value Fine	0 -255	Adjusts the center position of the brightness for the key color.
Despill	OFF, ON	Sets the spill removal (despill) for the key color.

6: DSK

Menu item	Value (bold text: default value)	Explanation
DSK 1, 2	These settings configure the DSK composite details for each DSK layer.	
Jump To Setup	Enter	Jumps to the setup screen.
DSK Mode (*10)	Sets the DSK mode.	
	Self Key	Uses the luminance key (brightness) and chroma key (color) to cut out the video image and create a composite by overlaying the video on a background video.
	Alpha Key	Uses alpha channels (areas which contain transparency data) to cut out still images and place them against different background video as a composite.
	External Key	Sets the key signal (the shape to be cut out) and the fill video (the video to be composited) separately (external key). This uses the key signal to cut out the fill video and superimpose it on the background video to create the composite.
	Roland Fill+Key	The content (title, images and video) in the dedicated Graphics Presenter app is superimposed and composited on the background image. * If you select "DSK 1" or "DSK 2" under Mode in the Roland Fill+Key menu, the setting automatically switches to "Roland Fill+Key".
DSK Source (*10)	HDMI 1–6, SDI 1–6, Still 1–2 –16, V.Player/SRT In (*11), Input 1–8 * When DSK Mode = Self Key Still 1–2 –16 * When DSK Mode = Alpha Key	Specifies the source of the caption or video that is overlaid.
Key Source (*10, *12)	HDMI 1–6, SDI 1–6, Still 1–2 –16, V.Player/SRT In (*11), Input 1–8	Sets the video to use as the key signal (the shape to be cut out). * Sets the default value to "HDMI 5–6" when you long-press the [VALUE] knob while DSK Mode = "External Key".
Fill Source (*10, *12)	HDMI 1–6, SDI 1–6, Still 1–2 –16, V.Player/SRT In (*11), Input 1–8	Specifies the fill video (the video to be composited) source. * Sets the default value to "HDMI 5–6" when you long-press the [VALUE] knob while DSK Mode = "External Key".
DSK Time	0.0– 1.0 –4.0sec	Specifies the video transition time.
DSK Type (*10, *13)	Specifies the DSK type used during DSK composition.	
	Luminance-White Key	Composite using luminance key. Makes white portions transparent according to brightness.
	Luminance-Black Key	Composite using luminance key. Makes black portions transparent according to brightness.
	Chroma Key	Composite using chroma key. Makes the specified key color transparent according to hue.
DSK Level (*10, *13)	0– 64 –255	Adjusts the degree of extraction (transparency) for the key.
DSK Gain (*10, *13)	0 –255	Adjusts the degree of edge blur (semi-transmissive region) for the key.
Mix Level	0– 255	Adjusts the key's overall density (output level).
Chroma (*10, *14)	Make detailed settings for chroma key.	
Color	Green, Blue	Specifies green or blue as the key color. If you want a color other than green or blue to turn transparent, use "Sampling Marker Mode" to specify the key color.
Hue Width	-30– 0 –30	Adjusts the hue width for the key color.
Hue Fine	0– 240 –360	Adjusts the center position of the hue for the key color.
Saturation Width	-128– 0 –127	Adjusts the saturation width for the key color.
Saturation Fine	0 –255	Adjusts the center position of saturation for the key color.
Value Width	-128– 0 –127	Adjusts the brightness width for the key color.
Value Fine	0 –255	Adjusts the center position of the brightness for the key color.
Despill	OFF, ON	Sets the spill removal (despill) for the key color.
Fill Type (*10)	Sets the fill material type (the video used for key compositing).	
	Bus	Uses the video specified in "DSK Source".
	Matte	Uses the internal color matte (a single-color image). The superimposed caption or video is filled in with the matte color. Specify the matte color using the "Matte Color" setting below.
Matte Color (*10, *15)	White, Yellow, Cyan, Green, Magenta, Red , Blue, Black, Custom	Specifies the matte color.
Edit (*10)	—	When Matte Color is "Custom", you can adjust the color of the matte.
Edge Type (*10)	Off , Border, Drop, Shadow, Outline	Specifies the type of edge applied to the superimposed caption or video.
Edge Color (*10)	White, Yellow, Cyan, Green, Magenta, Red, Blue, Black , Custom	Specifies the color of the edge applied to the superimposed caption or video.
Edit (*10)	—	When Matte Color is "Custom", you can adjust the color of the matte.
Edge Width (*10)	0– 3 –14	Specifies the width of the edge applied to the superimposed caption or video.

(*10) When Roland Fill+Key → Mode is set to "DSK 1" or "DSK 2", all other settings besides DSK Time and Mix Level are disabled.

(*11) Depending on the "Video Player/SRT In" → "Type" setting, either V.Player or SRT in is displayed.

(*12) This can be set if "DSK Mode" is "External Key".

(*13) This can be set if "DSK Mode" is "Self Key".

(*14) This can be set if "DSK Type" is "Chroma Key".

(*15) This can be set if "Fill Type" is "Matte".

7: Audio Fader/Knob Assign

Menu item	Value (bold text: default value)	Explanation
Jump To Setup	Enter	Jumps to the setup screen.
Input Fader 1–9/10	Audio In 1–9/10, USB In, Bluetooth In, Audio Player, HDMI 1–6, SDI 1–6, V.Player/SRT In (*16) The default values are as follows. Input Fader 1: Audio In 1 Input Fader 2: Audio In 2 Input Fader 3: Audio In 3 Input Fader 4: Audio In 4 Input Fader 5: Audio In 5 Input Fader 6: Audio In 6 Input Fader 7/8: Audio In 7/8 Input Fader 9/10: Audio In 9/10	Selects the audio input to assign to each fader.
Output Fader MAIN Output Knob AUX 1 Output Knob AUX 2 Output Knob USB OUT Output Knob STREAM/RECORD	Main Bus, AUX 1 Bus, AUX 2 Bus, AUX 3 Bus, USB Out, Stream/Record, Monitor Bus The default values are as follows. Output Fader MAIN: Main Bus Output Knob AUX 1: AUX 1 Bus Output Knob AUX 2: AUX 2 Bus Output Knob USB OUT: USB Out Output Knob STREAM/RECORD: Stream/Record	Selects the audio output to assign to each knob and fader.

(*16) Depending on the "Video Player/SRT In" → "Type" setting, either V.Player or SRT in is displayed.

8: Audio Input

Menu item	Value (bold text: default value)	Explanation
Audio In 1, 2	Adjusts the audio that is input from the AUDIO IN 1 and 2 jacks.	
Audio In 1/2 (Linked)	* "Audio In 1/2 (Linked)" is shown when "Stereo Link" is "ON".	
Jump To Setup	Enter	Jumps to the setup screen.
Analog Gain	0 –68dB	Adjusts the input gain (sensitivity) in the analog domain.
Digital Gain	–42.0– 0.0 –42.0dB	Adjusts the input gain (sensitivity) in the digital domain (after conversion from analog to digital).
Input Level	–INF –0.0–10.0dB	Adjusts the input volume. This can also be adjusted by the [1] or [2] fader. (*17)
Input Mute	OFF , ON	Turns the mute function on/off. When this is "ON", the input audio is temporarily silenced.
Phantom +48V	OFF , ON	Turns the phantom power on/off. When this is "ON", phantom power is supplied via the AUDIO IN jacks (XLR). * Changing "Stereo Link" settings automatically turns "Phantom +48V" settings "OFF".
Pan (*18)	Left– Center –Right	Adjusts the stereo position (pan).
Stereo Link	OFF , ON	Turns the stereo link function on/off. When this is "ON", Audio In 1 and 2 are linked, and operate as a stereo channel. * When stereo link is turned on, the settings of Audio In 1 are applied to Audio In 2.
Solo	OFF , ON	Turns the solo function on/off. Only the audio for which this is "ON" is heard in the headphones. * The solo function applies to the headphone output. It does not affect output other than the headphones.
Delay	0.0 –500msec (0 –25.0/29.9/30.0frame)	Adjusts the delay time of the audio. Effect Outputs audio with a delay.
Reverb Send	0 –127	Adjusts the amount of audio sent to reverb.
Main Bus	This configures the Main bus.	
Send	OFF, ON	When this is "ON", audio is sent to the Main bus.
AUX 1 Bus	This configures the AUX 1 bus.	
Send Level	–INF –10.0dB	These parameters adjust the amount of audio sent to the AUX 1 bus.
Send Point	Dry	Sends the source audio with no effects applied.
	Pre Fader	Sends the effect-applied audio. The send volume is constant, regardless of the volume (Input Level).
	Post Fader	Sends the effect-applied audio. The send volume can be changed by adjusting the volume (Input Level).
AUX 2 Bus	This configures the AUX 2 bus.	
Send Level	–INF –10.0dB	These parameters adjust the amount of audio sent to the AUX 2 bus.
Send Point	Dry	Sends the source audio with no effects applied.
	Pre Fader	Sends the effect-applied audio. The send volume is constant, regardless of the volume (Input Level).
	Post Fader	Sends the effect-applied audio. The send volume can be changed by adjusting the volume (Input Level).
AUX 3 Bus	This configures the AUX 3 bus.	
Send Level	–INF –10.0dB	These parameters adjust the amount of audio sent to the AUX 3 bus.
Send Point	Dry	Sends the source audio with no effects applied.
	Pre Fader	Sends the effect-applied audio. The send volume is constant, regardless of the volume (Input Level).
	Post Fader	Sends the effect-applied audio. The send volume can be changed by adjusting the volume (Input Level).
High Pass Filter	OFF , ON	Turns the high-pass filter on/off. Effect Cuts off unneeded low-band audio.
Frequency	20.0Hz– 80.0Hz –1.00kHz	Specifies the cutoff frequency.
Echo Canceller	OFF , ON	Turns the echo canceller on/off. Effect Suppresses the voice echo that can occur when using a web conferencing system that includes a speaker and mic.
Depth	1– 5 –10	Adjusts the depth of the echo canceller.
Anti Feedback	OFF , ON	Turns the anti-feedback on/off. Effect Suppresses audio feedback.

(*17) The [2] fader is disabled when "Stereo Link" is "ON".

(*18) This can be set if "Stereo Link" is "OFF".

Menu item	Value (bold text: default value)	Explanation
Noise Gate	OFF , ON	Turns the noise gate on/off. Effect Eliminates audio that is lower than the specified threshold level. This is effective when the noise that you want to remove is separate from the audio that you want to keep, and can be used to remove hiss or other noise that is heard during periods of silence.
Threshold	-80-- 48 -0dB	Specifies the level used as the threshold for removing audio. Audio below the level set here is removed.
Release	30- 500 -5000msec	Adjusts the length of time until the audio is fully attenuated after audio falls below the threshold.
De-Esser	OFF , ON	Turns the de-esser on/off. Effect Reduces sibilant noise (the sounds you hear when pronouncing "s" words and other hissing sounds).
Sens	0- 80 -100	Adjusts the sensitivity with which sibilants are detected.
Depth	0- 64 -100	Adjusts the intensity of the effect.
Compressor	OFF , ON	Turns the compressor on/off. Effect Audio that exceeds the specified threshold level is compressed. This reduces the difference between the maximum volume and minimum volume, making the audio more comfortable for listening.
Threshold	-50-- 8 -0dB	Specifies the level used as the threshold at which the compressor is applied. Compression is applied to audio that exceeds the threshold.
Ratio	1.00: 1, 1.12: 1, 1.25: 1, 1.40: 1, 1.60: 1, 1.80: 1, 2.00: 1, 2.50: 1 , 3.20: 1, 4.00: 1, 5.60: 1, 8.00: 1, 16.0: 1, INF: 1	Specifies the degree of compression applied to the audio. The state in which no compression is applied is defined as "1".
Attack	0.0- 30 -100msec	Specifies the time until compression starts when audio exceeding the threshold is input.
Release	30- 250 -5000msec	Adjusts the length of time until compression ends after audio falls below the threshold.
Makeup Gain	-40- 0 -40dB	Adjusts the final output volume level after applying the compressor.
Equalizer	OFF , ON	Turns the equalizer on/off. Effect This is a 4-band parametric equalizer. It lets you shape the character of the sound by boosting or cutting four frequency regions.
Hi Gain	-12.0- 0.0 -12.0dB	Boosts or attenuates the high band.
Hi Freq	1.00- 10.0 -20.0kHz	Adjusts the center frequency when changing the tone quality in the high band.
Hi-Mid Gain	-12.0- 0.0 -12.0dB	Boosts or attenuates the high-midrange band.
Hi-Mid Freq	20.0Hz- 2.00kHz -20.0kHz	Adjusts the center frequency when changing the tone quality in the high-midrange band.
Hi-Mid Q	0.5- 1.0 -16.0	Adjusts the width of the frequency band when boosting or attenuating high-midrange band.
Lo-Mid Gain	-12.0- 0.0 -12.0dB	Boosts or attenuates the low-midrange band.
Lo-Mid Freq	20.0Hz- 500Hz -20.0kHz	Adjusts the center frequency when changing the tone quality in the low-midrange band.
Lo-Mid Q	0.5- 1.0 -16.0	Adjusts the width of the frequency band when boosting or attenuating low-midrange band.
Lo Gain	-12.0- 0.0 -12.0dB	Boosts or attenuates the low band.
Lo Freq	20.0Hz- 100Hz -2.00kHz	Adjusts the center frequency when changing the tone quality in the low band.
Voice Changer	OFF , ON	Turns the voice changer on/off. Effect Transforms the pitch or character of the voice.
Pitch	-12- +12	Adjusts the pitch of the voice in semitone steps. A setting of "0" is the original pitch.
Formant	-10- +4 +10	Adjusts the character (formant) of the voice. Settings in the negative (-) direction produce a more masculine vocal character, and settings in the positive (+) direction produce a more feminine vocal character. A setting of "0" is the original voice.
Robot	OFF , ON	If this is "ON", the voice is held at a fixed pitch, creating a mechanical robot-like impression.
Mix	0- 100	Adjusts the balance between the unprocessed voice (0) and the voice processed by the effect (100).

Menu item	Value (bold text: default value)	Explanation
Audio In 3–6 Audio In 3/4 (Linked) Audio In 5/6 (Linked)	Adjusts the audio that is input from the AUDIO IN 3 – 6 jacks. * "Audio In 3/4 (Linked)" "Audio In 5/6 (Linked)" is shown when "Stereo Link" is "ON".	
Jump To Setup	Enter	Jumps to the setup screen.
Analog Gain	0 –68db	Adjusts the input gain (sensitivity) in the analog domain.
Digital Gain	–42.0– 0.0 –42.0dB	Adjusts the input gain (sensitivity) in the digital domain (after conversion from analog to digital).
Input Level	–INF –0.0–10.0dB	Adjusts the input volume. This can also be adjusted by the [3]–[6] fader. (*19)
Input Mute	OFF , ON	Turns the mute function on/off. When this is "ON", the input audio is temporarily silenced.
Phantom +48V	OFF , ON	Turns the phantom power on/off. When this is "ON", phantom power is supplied via the AUDIO IN jacks (XLR). * Changing "Stereo Link" settings automatically turns "Phantom +48V" settings "OFF".
Pan (*20)	Left– Center –Right	Adjusts the stereo position (pan).
Stereo Link	OFF , ON	Turns the stereo link function on/off. When this is "ON", Audio In 3 and 4 (5 and 6) are linked, and operate as a stereo channel. * When stereo link is turned on, the settings of Audio In 3 (5) are applied to Audio In 4 (6).
Solo	OFF , ON	Turns the solo function on/off. Only the audio for which this is "ON" is heard in the headphones. * The solo function applies to the headphone output. It does not affect output other than the headphones.
Delay	0.0 –500msec (0 –25.0/29.9/30.0frame)	Adjusts the delay time of the audio. Effect Outputs audio with a delay.
Reverb Send	0 –127	Adjusts the amount of audio sent to reverb.
Main Bus	This configures the Main bus.	
Send	OFF, ON	When this is "ON", audio is sent to the Main bus.
AUX 1 Bus	This configures the AUX 1 bus.	
Send Level	–INF –10.0dB	These parameters adjust the amount of audio sent to the AUX 1 bus.
Send Point	Dry	Sends the source audio with no effects applied.
	Pre Fader	Sends the effect-applied audio. The send volume is constant, regardless of the volume (Input Level).
	Post Fader	Sends the effect-applied audio. The send volume can be changed by adjusting the volume (Input Level).
AUX 2 Bus	This configures the AUX 2 bus.	
Send Level	–INF –10.0dB	These parameters adjust the amount of audio sent to the AUX 2 bus.
Send Point	Dry	Sends the source audio with no effects applied.
	Pre Fader	Sends the effect-applied audio. The send volume is constant, regardless of the volume (Input Level).
	Post Fader	Sends the effect-applied audio. The send volume can be changed by adjusting the volume (Input Level).
AUX 3 Bus	This configures the AUX 3 bus.	
Send Level	–INF –10.0dB	These parameters adjust the amount of audio sent to the AUX 3 bus.
Send Point	Dry	Sends the source audio with no effects applied.
	Pre Fader	Sends the effect-applied audio. The send volume is constant, regardless of the volume (Input Level).
	Post Fader	Sends the effect-applied audio. The send volume can be changed by adjusting the volume (Input Level).
High Pass Filter	OFF , ON	Turns the high-pass filter on/off. Effect Cuts off unneeded low-band audio.
Frequency	20.0Hz– 80.0Hz –1.00kHz	Specifies the cutoff frequency.
Noise Gate	OFF , ON	Turns the noise gate on/off. Effect Eliminates audio that is lower than the specified threshold level. This is effective when the noise that you want to remove is separate from the audio that you want to keep, and can be used to remove hiss or other noise that is heard during periods of silence.
Threshold	–80– –48 –0dB	Specifies the level used as the threshold for removing audio. Audio below the level set here is removed.
Release	30– 500 –5000msec	Adjusts the length of time until the audio is fully attenuated after audio falls below the threshold.

(*19) The [4] [6] fader is disabled when "Stereo Link" is "ON".

(*20) This can be set if "Stereo Link" is "OFF".

Menu List

Menu item	Value (bold text: default value)	Explanation
De-Esser	OFF , ON	Turns the de-esser on/off. Effect Reduces sibilant noise (the sounds you hear when pronouncing “s” words and other hissing sounds).
Sens	0– 80 –100	Adjusts the sensitivity with which sibilants are detected.
Depth	0– 64 –100	Adjusts the intensity of the effect.
Compressor	OFF , ON	Turns the compressor on/off. Effect Audio that exceeds the specified threshold level is compressed. This reduces the difference between the maximum volume and minimum volume, making the audio more comfortable for listening.
Threshold	-50– 8 –0dB	Specifies the level used as the threshold at which the compressor is applied. Compression is applied to audio that exceeds the threshold.
Ratio	1.00: 1, 1.12: 1, 1.25: 1, 1.40: 1, 1.60: 1, 1.80: 1, 2.00: 1, 2.50: 1 , 3.20: 1, 4.00: 1, 5.60: 1, 8.00: 1, 16.0: 1, INF: 1	Specifies the degree of compression applied to the audio. The state in which no compression is applied is defined as “1”.
Attack	0.0– 30 –100msec	Specifies the time until compression starts when audio exceeding the threshold is input.
Release	30– 250 –5000msec	Adjusts the length of time until compression ends after audio falls below the threshold.
Makeup Gain	-40– 0 –40dB	Adjusts the final output volume level after applying the compressor.
Equalizer	OFF , ON	Turns the equalizer on/off. Effect This is a 4-band parametric equalizer. It lets you shape the character of the sound by boosting or cutting four frequency regions.
Hi Gain	-12.0– 0.0 –12.0dB	Boosts or attenuates the high band.
Hi Freq	1.00– 10.0 –20.0kHz	Adjusts the center frequency when changing the tone quality in the high band.
Hi-Mid Gain	-12.0– 0.0 –12.0dB	Boosts or attenuates the high-midrange band.
Hi-Mid Freq	20.0Hz– 2.00kHz –20.0kHz	Adjusts the center frequency when changing the tone quality in the high-midrange band.
Hi-Mid Q	0.5– 1.0 –16.0	Adjusts the width of the frequency band when boosting or attenuating high-midrange band.
Lo-Mid Gain	-12.0– 0.0 –12.0dB	Boosts or attenuates the low-midrange band.
Lo-Mid Freq	20.0Hz– 500Hz –20.0kHz	Adjusts the center frequency when changing the tone quality in the low-midrange band.
Lo-Mid Q	0.5– 1.0 –16.0	Adjusts the width of the frequency band when boosting or attenuating low-midrange band.
Lo Gain	-12.0– 0.0 –12.0dB	Boosts or attenuates the low band.
Lo Freq	20.0Hz– 100Hz –2.00kHz	Adjusts the center frequency when changing the tone quality in the low band.

Menu item	Value (bold text: default value)	Explanation
Audio In 7/8 Audio In 9/10	Adjusts the audio that is input from the AUDIO IN 7/8 – 9/10 jacks.	
Jump To Setup	Enter	Jumps to the setup screen.
Digital Gain	-42.0– 0.0 –42.0dB	Adjusts the input gain (sensitivity) in the digital domain (after conversion from analog to digital).
Input Level	-INF –0.0–10.0dB	Adjusts the input volume. This can also be adjusted by the [7/8]–[9/10] fader.
Input Mute	OFF , ON	Turns the mute function on/off. When this is “ON”, the input audio is temporarily silenced.
Mono	Converts the input audio from stereo to mono.	
	Off	Sends the stereo input audio without change.
	L Only	The audio of the L channel is sent to both L and R.
	R Only	The audio of the R channel is sent to both L and R.
LR Mix	The audio of the L channel and R channel is mixed, and sent to both L and R.	
Solo	OFF , ON	Turns the solo function on/off. Only the audio for which this is “ON” is heard in the headphones. * The solo function applies to the headphone output. It does not affect output other than the headphones.
Delay	0.0 –500msec (0 –25.0/29.9/30.0frame)	Adjusts the delay time of the audio. Effect Outputs audio with a delay.
Reverb Send	0 –127	Adjusts the amount of audio sent to reverb.
Main Bus	This configures the Main bus.	
Send	OFF, ON	When this is “ON”, audio is sent to the Main bus.
AUX 1 Bus	This configures the AUX 1 bus.	
Send Level	-INF –10.0dB	These parameters adjust the amount of audio sent to the AUX 1 bus.
Send Point	Dry	Sends the source audio with no effects applied.
	Pre Fader	Sends the effect-applied audio. The send volume is constant, regardless of the volume (Input Level).
	Post Fader	Sends the effect-applied audio. The send volume can be changed by adjusting the volume (Input Level).
AUX 2 Bus	This configures the AUX 2 bus.	
Send Level	-INF –10.0dB	These parameters adjust the amount of audio sent to the AUX 2 bus.
Send Point	Dry	Sends the source audio with no effects applied.
	Pre Fader	Sends the effect-applied audio. The send volume is constant, regardless of the volume (Input Level).
	Post Fader	Sends the effect-applied audio. The send volume can be changed by adjusting the volume (Input Level).
AUX 3 Bus	This configures the AUX 3 bus.	
Send Level	-INF –10.0dB	These parameters adjust the amount of audio sent to the AUX 3 bus.
Send Point	Dry	Sends the source audio with no effects applied.
	Pre Fader	Sends the effect-applied audio. The send volume is constant, regardless of the volume (Input Level).
	Post Fader	Sends the effect-applied audio. The send volume can be changed by adjusting the volume (Input Level).
High Pass Filter	OFF , ON	Turns the high-pass filter on/off. Effect Cuts off unneeded low-band audio.
Frequency	20.0Hz– 80.0Hz –1.00kHz	Specifies the cutoff frequency.
Noise Gate	OFF , ON	Turns the noise gate on/off. Effect Eliminates audio that is lower than the specified threshold level. This is effective when the noise that you want to remove is separate from the audio that you want to keep, and can be used to remove hiss or other noise that is heard during periods of silence.
Threshold	-80– -48 –0dB	Specifies the level used as the threshold for removing audio. Audio below the level set here is removed.
Release	30– 500 –5000msec	Adjusts the length of time until the audio is fully attenuated after audio falls below the threshold.

Menu item	Value (bold text: default value)	Explanation
Compressor	OFF , ON	Turns the compressor on/off. Effect Audio that exceeds the specified threshold level is compressed. This reduces the difference between the maximum volume and minimum volume, making the audio more comfortable for listening.
Threshold	-50-- 8 -0dB	Specifies the level used as the threshold at which the compressor is applied. Compression is applied to audio that exceeds the threshold.
Ratio	1.00: 1, 1.12: 1, 1.25: 1, 1.40: 1, 1.60: 1, 1.80: 1, 2.00: 1, 2.50: 1 , 3.20: 1, 4.00: 1, 5.60: 1, 8.00: 1, 16.0: 1, INF: 1	Specifies the degree of compression applied to the audio. The state in which no compression is applied is defined as "1".
Attack	0.0-- 30 -100msec	Specifies the time until compression starts when audio exceeding the threshold is input.
Release	30-- 250 -5000msec	Adjusts the length of time until compression ends after audio falls below the threshold.
Makeup Gain	-40-- 0 -40dB	Adjusts the final output volume level after applying the compressor.
Equalizer	OFF , ON	Turns the equalizer on/off. Effect This is a 4-band parametric equalizer. It lets you shape the character of the sound by boosting or cutting four frequency regions.
Hi Gain	-12.0-- 0.0 -12.0dB	Boosts or attenuates the high band.
Hi Freq	1.00-- 10.0 -20.0kHz	Adjusts the center frequency when changing the tone quality in the high band.
Hi-Mid Gain	-12.0-- 0.0 -12.0dB	Boosts or attenuates the high-midrange band.
Hi-Mid Freq	20.0Hz-- 2.00kHz -20.0kHz	Adjusts the center frequency when changing the tone quality in the high-midrange band.
Hi-Mid Q	0.5-- 1.0 -16.0	Adjusts the width of the frequency band when boosting or attenuating high-midrange band.
Lo-Mid Gain	-12.0-- 0.0 -12.0dB	Boosts or attenuates the low-midrange band.
Lo-Mid Freq	20.0Hz-- 500Hz -20.0kHz	Adjusts the center frequency when changing the tone quality in the low-midrange band.
Lo-Mid Q	0.5-- 1.0 -16.0	Adjusts the width of the frequency band when boosting or attenuating low-midrange band.
Lo Gain	-12.0-- 0.0 -12.0dB	Boosts or attenuates the low band.
Lo Freq	20.0Hz-- 100Hz -2.00kHz	Adjusts the center frequency when changing the tone quality in the low band.

Menu item	Value (bold text: default value)	Explanation	
USB In Adjusts the audio that is input from the USB STREAM port.			
Jump To Setup	Enter	Jumps to the setup screen.	
Digital Gain	-42.0– 0.0 –42.0dB	Adjusts the input gain (sensitivity) in the digital domain (after conversion from analog to digital).	
Input Level	-INF– 0.0 –10.0dB	Adjusts the input volume.	
Input Mute	OFF , ON	Turns the mute function on/off. When this is “ON”, the input audio is temporarily silenced.	
Mono	Converts the input audio from stereo to mono.		
	Off	Sends the stereo input audio without change.	
	L Only	The audio of the L channel is sent to both L and R.	
	R Only	The audio of the R channel is sent to both L and R.	
LR Mix	The audio of the L channel and R channel is mixed, and sent to both L and R.		
Solo	OFF , ON	Turns the solo function on/off. Only the audio for which this is “ON” is heard in the headphones. * The solo function applies to the headphone output. It does not affect output other than the headphones.	
Delay	0.0 –500msec (0 –25.0/29.9/30.0frame)	Adjusts the delay time of the audio. Effect Outputs audio with a delay.	
Reverb Send	0 –127	Adjusts the amount of audio sent to reverb.	
Main Bus This configures the Main bus.			
Send	OFF, ON	When this is “ON”, audio is sent to the Main bus.	
AUX 1 Bus This configures the AUX 1 bus.			
Send Level	-INF–10.0dB	These parameters adjust the amount of audio sent to the AUX 1 bus.	
Send Point	Dry	Sends the source audio with no effects applied.	
	Pre Fader	Sends the effect-applied audio. The send volume is constant, regardless of the volume (Input Level).	
	Post Fader	Sends the effect-applied audio. The send volume can be changed by adjusting the volume (Input Level).	
AUX 2 Bus This configures the AUX 2 bus.			
Send Level	-INF–10.0dB	These parameters adjust the amount of audio sent to the AUX 2 bus.	
Send Point	Dry	Sends the source audio with no effects applied.	
	Pre Fader	Sends the effect-applied audio. The send volume is constant, regardless of the volume (Input Level).	
	Post Fader	Sends the effect-applied audio. The send volume can be changed by adjusting the volume (Input Level).	
AUX 3 Bus This configures the AUX 3 bus.			
Send Level	-INF–10.0dB	These parameters adjust the amount of audio sent to the AUX 3 bus.	
Send Point	Dry	Sends the source audio with no effects applied.	
	Pre Fader	Sends the effect-applied audio. The send volume is constant, regardless of the volume (Input Level).	
	Post Fader	Sends the effect-applied audio. The send volume can be changed by adjusting the volume (Input Level).	
High Pass Filter	OFF , ON	Turns the high-pass filter on/off. Effect Cuts off unneeded low-band audio.	
Frequency	20.0Hz– 80.0Hz –1.00kHz	Specifies the cutoff frequency.	
Noise Gate	Turns the noise gate on/off.		
	OFF , ON	Effect Eliminates audio that is lower than the specified threshold level. This is effective when the noise that you want to remove is separate from the audio that you want to keep, and can be used to remove hiss or other noise that is heard during periods of silence.	
	Threshold	-80– -48 –0dB	Specifies the level used as the threshold for removing audio. Audio below the level set here is removed.
	Release	30– 500 –5000msec	Adjusts the length of time until the audio is fully attenuated after audio falls below the threshold.

Menu List

Menu item	Value (bold text: default value)	Explanation
Compressor	OFF , ON	Turns the compressor on/off. Effect Audio that exceeds the specified threshold level is compressed. This reduces the difference between the maximum volume and minimum volume, making the audio more comfortable for listening.
Threshold	-50-- 8 -0dB	Specifies the level used as the threshold at which the compressor is applied. Compression is applied to audio that exceeds the threshold.
Ratio	1.00: 1, 1.12: 1, 1.25: 1, 1.40: 1, 1.60: 1, 1.80: 1, 2.00: 1, 2.50: 1 , 3.20: 1, 4.00: 1, 5.60: 1, 8.00: 1, 16.0: 1, INF: 1	Specifies the degree of compression applied to the audio. The state in which no compression is applied is defined as "1".
Attack	0.0-- 30 -100msec	Specifies the time until compression starts when audio exceeding the threshold is input.
Release	30-- 250 -5000msec	Adjusts the length of time until compression ends after audio falls below the threshold.
Makeup Gain	-40-- 0 -40dB	Adjusts the final output volume level after applying the compressor.
Equalizer	OFF , ON	Turns the equalizer on/off. Effect This is a 4-band parametric equalizer. It lets you shape the character of the sound by boosting or cutting four frequency regions.
Hi Gain	-12.0-- 0.0 -12.0dB	Boosts or attenuates the high band.
Hi Freq	1.00-- 10.0 -20.0kHz	Adjusts the center frequency when changing the tone quality in the high band.
Hi-Mid Gain	-12.0-- 0.0 -12.0dB	Boosts or attenuates the high-midrange band.
Hi-Mid Freq	20.0Hz-- 2.00kHz -20.0kHz	Adjusts the center frequency when changing the tone quality in the high-midrange band.
Hi-Mid Q	0.5-- 1.0 -16.0	Adjusts the width of the frequency band when boosting or attenuating high-midrange band.
Lo-Mid Gain	-12.0-- 0.0 -12.0dB	Boosts or attenuates the low-midrange band.
Lo-Mid Freq	20.0Hz-- 500Hz -20.0kHz	Adjusts the center frequency when changing the tone quality in the low-midrange band.
Lo-Mid Q	0.5-- 1.0 -16.0	Adjusts the width of the frequency band when boosting or attenuating low-midrange band.
Lo Gain	-12.0-- 0.0 -12.0dB	Boosts or attenuates the low band.
Lo Freq	20.0Hz-- 100Hz -2.00kHz	Adjusts the center frequency when changing the tone quality in the low band.

Menu item	Value (bold text: default value)	Explanation	
Bluetooth In These parameters adjust the audio input via Bluetooth.			
Jump To Setup	Enter	Jumps to the setup screen.	
Digital Gain	-42.0– 0.0 –42.0dB	Adjusts the input gain (sensitivity) in the digital domain (after conversion from analog to digital).	
Input Level	-INF– 0.0 –10.0dB	Adjusts the input volume.	
Input Mute	OFF , ON	Turns the mute function on/off. When this is “ON”, the input audio is temporarily silenced.	
Mono	Converts the input audio from stereo to mono.		
	Off	Sends the stereo input audio without change.	
	L Only	The audio of the L channel is sent to both L and R.	
	R Only	The audio of the R channel is sent to both L and R.	
LR Mix	The audio of the L channel and R channel is mixed, and sent to both L and R.		
Solo	OFF , ON	Turns the solo function on/off. Only the audio for which this is “ON” is heard in the headphones. * The solo function applies to the headphone output. It does not affect output other than the headphones.	
Delay	0.0 –500msec (0 –25.0/29.9/30.0frame)	Adjusts the delay time of the audio. Effect Outputs audio with a delay.	
Reverb Send	0 –127	Adjusts the amount of audio sent to reverb.	
Main Bus This configures the Main bus.			
Send	OFF, ON	When this is “ON”, audio is sent to the Main bus.	
AUX 1 Bus This configures the AUX 1 bus.			
Send Level	-INF–10.0dB	These parameters adjust the amount of audio sent to the AUX 1 bus.	
Send Point	Dry	Sends the source audio with no effects applied.	
	Pre Fader	Sends the effect-applied audio. The send volume is constant, regardless of the volume (Input Level).	
	Post Fader	Sends the effect-applied audio. The send volume can be changed by adjusting the volume (Input Level).	
AUX 2 Bus This configures the AUX 2 bus.			
Send Level	-INF–10.0dB	These parameters adjust the amount of audio sent to the AUX 2 bus.	
Send Point	Dry	Sends the source audio with no effects applied.	
	Pre Fader	Sends the effect-applied audio. The send volume is constant, regardless of the volume (Input Level).	
	Post Fader	Sends the effect-applied audio. The send volume can be changed by adjusting the volume (Input Level).	
AUX 3 Bus This configures the AUX 3 bus.			
Send Level	-INF–10.0dB	These parameters adjust the amount of audio sent to the AUX 3 bus.	
Send Point	Dry	Sends the source audio with no effects applied.	
	Pre Fader	Sends the effect-applied audio. The send volume is constant, regardless of the volume (Input Level).	
	Post Fader	Sends the effect-applied audio. The send volume can be changed by adjusting the volume (Input Level).	
High Pass Filter	OFF , ON	Turns the high-pass filter on/off. Effect Cuts off unneeded low-band audio.	
Frequency	20.0Hz– 80.0Hz –1.00kHz	Specifies the cutoff frequency.	
Noise Gate	Turns the noise gate on/off.		
	OFF , ON	Effect Eliminates audio that is lower than the specified threshold level. This is effective when the noise that you want to remove is separate from the audio that you want to keep, and can be used to remove hiss or other noise that is heard during periods of silence.	
	Threshold	-80– -48 –0dB	Specifies the level used as the threshold for removing audio. Audio below the level set here is removed.
	Release	30– 500 –5000msec	Adjusts the length of time until the audio is fully attenuated after audio falls below the threshold.

Menu item	Value (bold text: default value)	Explanation
Compressor	OFF , ON	Turns the compressor on/off. Effect Audio that exceeds the specified threshold level is compressed. This reduces the difference between the maximum volume and minimum volume, making the audio more comfortable for listening.
Threshold	-50-- 8 -0dB	Specifies the level used as the threshold at which the compressor is applied. Compression is applied to audio that exceeds the threshold.
Ratio	1.00: 1, 1.12: 1, 1.25: 1, 1.40: 1, 1.60: 1, 1.80: 1, 2.00: 1, 2.50: 1 , 3.20: 1, 4.00: 1, 5.60: 1, 8.00: 1, 16.0: 1, INF: 1	Specifies the degree of compression applied to the audio. The state in which no compression is applied is defined as "1".
Attack	0.0-- 30 -100msec	Specifies the time until compression starts when audio exceeding the threshold is input.
Release	30-- 250 -5000msec	Adjusts the length of time until compression ends after audio falls below the threshold.
Makeup Gain	-40-- 0 -40dB	Adjusts the final output volume level after applying the compressor.
Equalizer	OFF , ON	Turns the equalizer on/off. Effect This is a 4-band parametric equalizer. It lets you shape the character of the sound by boosting or cutting four frequency regions.
Hi Gain	-12.0-- 0.0 -12.0dB	Boosts or attenuates the high band.
Hi Freq	1.00-- 10.0 -20.0kHz	Adjusts the center frequency when changing the tone quality in the high band.
Hi-Mid Gain	-12.0-- 0.0 -12.0dB	Boosts or attenuates the high-midrange band.
Hi-Mid Freq	20.0Hz-- 2.00kHz -20.0kHz	Adjusts the center frequency when changing the tone quality in the high-midrange band.
Hi-Mid Q	0.5-- 1.0 -16.0	Adjusts the width of the frequency band when boosting or attenuating high-midrange band.
Lo-Mid Gain	-12.0-- 0.0 -12.0dB	Boosts or attenuates the low-midrange band.
Lo-Mid Freq	20.0Hz-- 500Hz -20.0kHz	Adjusts the center frequency when changing the tone quality in the low-midrange band.
Lo-Mid Q	0.5-- 1.0 -16.0	Adjusts the width of the frequency band when boosting or attenuating low-midrange band.
Lo Gain	-12.0-- 0.0 -12.0dB	Boosts or attenuates the low band.
Lo Freq	20.0Hz-- 100Hz -2.00kHz	Adjusts the center frequency when changing the tone quality in the low band.

Menu item	Value (bold text: default value)	Explanation	
Audio Player These parameters adjust the audio input from the audio player.			
Jump To Setup	Enter	Jumps to the setup screen.	
Digital Gain	-42.0– 0.0 –42.0dB	Adjusts the input gain (sensitivity) in the digital domain (after conversion from analog to digital).	
Input Level	-INF– 0.0 –10.0dB	Adjusts the input volume.	
Input Mute	OFF , ON	Turns the mute function on/off. When this is “ON”, the input audio is temporarily silenced.	
Mono	Converts the input audio from stereo to mono.		
	Off	Sends the stereo input audio without change.	
	L Only	The audio of the L channel is sent to both L and R.	
	R Only	The audio of the R channel is sent to both L and R.	
LR Mix	The audio of the L channel and R channel is mixed, and sent to both L and R.		
Solo	OFF , ON	Turns the solo function on/off. Only the audio for which this is “ON” is heard in the headphones. * The solo function applies to the headphone output. It does not affect output other than the headphones.	
Delay	0.0 –500msec (0 –25.0/29.9/30.0frame)	Adjusts the delay time of the audio. Effect Outputs audio with a delay.	
Reverb Send	0 –127	Adjusts the amount of audio sent to reverb.	
Main Bus This configures the Main bus.			
Send	OFF, ON	When this is “ON”, audio is sent to the Main bus.	
AUX 1 Bus This configures the AUX 1 bus.			
Send Level	-INF–10.0dB	These parameters adjust the amount of audio sent to the AUX 1 bus.	
Send Point	Dry	Sends the source audio with no effects applied.	
	Pre Fader	Sends the effect-applied audio. The send volume is constant, regardless of the volume (Input Level).	
	Post Fader	Sends the effect-applied audio. The send volume can be changed by adjusting the volume (Input Level).	
AUX 2 Bus This configures the AUX 2 bus.			
Send Level	-INF–10.0dB	These parameters adjust the amount of audio sent to the AUX 2 bus.	
Send Point	Dry	Sends the source audio with no effects applied.	
	Pre Fader	Sends the effect-applied audio. The send volume is constant, regardless of the volume (Input Level).	
	Post Fader	Sends the effect-applied audio. The send volume can be changed by adjusting the volume (Input Level).	
AUX 3 Bus This configures the AUX 3 bus.			
Send Level	-INF–10.0dB	These parameters adjust the amount of audio sent to the AUX 3 bus.	
Send Point	Dry	Sends the source audio with no effects applied.	
	Pre Fader	Sends the effect-applied audio. The send volume is constant, regardless of the volume (Input Level).	
	Post Fader	Sends the effect-applied audio. The send volume can be changed by adjusting the volume (Input Level).	
High Pass Filter	OFF , ON	Turns the high-pass filter on/off. Effect Cuts off unneeded low-band audio.	
Frequency	20.0Hz– 80.0Hz –1.00kHz	Specifies the cutoff frequency.	
Noise Gate	Turns the noise gate on/off.		
	OFF , ON	Effect Eliminates audio that is lower than the specified threshold level. This is effective when the noise that you want to remove is separate from the audio that you want to keep, and can be used to remove hiss or other noise that is heard during periods of silence.	
	Threshold	-80– -48 –0dB	Specifies the level used as the threshold for removing audio. Audio below the level set here is removed.
	Release	30– 500 –5000msec	Adjusts the length of time until the audio is fully attenuated after audio falls below the threshold.

Menu List

Menu item	Value (bold text: default value)	Explanation
Compressor	OFF , ON	Turns the compressor on/off. Effect Audio that exceeds the specified threshold level is compressed. This reduces the difference between the maximum volume and minimum volume, making the audio more comfortable for listening.
Threshold	-50-- 8 -0dB	Specifies the level used as the threshold at which the compressor is applied. Compression is applied to audio that exceeds the threshold.
Ratio	1.00: 1, 1.12: 1, 1.25: 1, 1.40: 1, 1.60: 1, 1.80: 1, 2.00: 1, 2.50: 1 , 3.20: 1, 4.00: 1, 5.60: 1, 8.00: 1, 16.0: 1, INF: 1	Specifies the degree of compression applied to the audio. The state in which no compression is applied is defined as "1".
Attack	0.0-- 30 -100msec	Specifies the time until compression starts when audio exceeding the threshold is input.
Release	30-- 250 -5000msec	Adjusts the length of time until compression ends after audio falls below the threshold.
Makeup Gain	-40-- 0 -40dB	Adjusts the final output volume level after applying the compressor.
Equalizer	OFF , ON	Turns the equalizer on/off. Effect This is a 4-band parametric equalizer. It lets you shape the character of the sound by boosting or cutting four frequency regions.
Hi Gain	-12.0-- 0.0 -12.0dB	Boosts or attenuates the high band.
Hi Freq	1.00-- 10.0 -20.0kHz	Adjusts the center frequency when changing the tone quality in the high band.
Hi-Mid Gain	-12.0-- 0.0 -12.0dB	Boosts or attenuates the high-midrange band.
Hi-Mid Freq	20.0Hz-- 2.00kHz -20.0kHz	Adjusts the center frequency when changing the tone quality in the high-midrange band.
Hi-Mid Q	0.5-- 1.0 -16.0	Adjusts the width of the frequency band when boosting or attenuating high-midrange band.
Lo-Mid Gain	-12.0-- 0.0 -12.0dB	Boosts or attenuates the low-midrange band.
Lo-Mid Freq	20.0Hz-- 500Hz -20.0kHz	Adjusts the center frequency when changing the tone quality in the low-midrange band.
Lo-Mid Q	0.5-- 1.0 -16.0	Adjusts the width of the frequency band when boosting or attenuating low-midrange band.
Lo Gain	-12.0-- 0.0 -12.0dB	Boosts or attenuates the low band.
Lo Freq	20.0Hz-- 100Hz -2.00kHz	Adjusts the center frequency when changing the tone quality in the low band.

Menu item	Value (bold text: default value)	Explanation
HDMI In 1–6 Adjusts the audio that is input from the HDMI IN 1–6 connectors.		
Jump To Setup	Enter	Jumps to the setup screen.
Embedded Audio Channel	1/2, 3/4, 5/6, 7/8	Selects the channel used for embedded audio.
Digital Gain	-42.0– 0.0 –42.0dB	Adjusts the digital gain.
Input Level	-INF– 0.0 –10.0dB	Adjusts the input volume.
Input Mute	OFF , ON	Turns the mute function on/off. When this is “ON”, the input audio is temporarily silenced.
Mono	Converts the input audio from stereo to mono.	
	Off	Sends the stereo input audio without change.
	L Only	The audio of the L channel is sent to both L and R.
	R Only	The audio of the R channel is sent to both L and R.
LR Mix	The audio of the L channel and R channel is mixed, and sent to both L and R.	
Solo	OFF , ON	Turns the solo function on/off. Only the audio for which this is “ON” is heard in the headphones. * The solo function applies to the headphone output. It does not affect output other than the headphones.
Delay	0.0 –500msec (0 –25.0/29.9/30.0frame)	Adjusts the delay time of the audio. Effect Outputs audio with a delay.
Reverb Send	0 –127	Adjusts the amount of audio sent to reverb.
Main Bus This configures the Main bus.		
Send	OFF, ON	When this is “ON”, audio is sent to the Main bus.
AUX 1 Bus This configures the AUX 1 bus.		
Send Level	-INF–10.0dB	These parameters adjust the amount of audio sent to the AUX 1 bus.
Send Point	Dry	Sends the source audio with no effects applied.
	Pre Fader	Sends the effect-applied audio. The send volume is constant, regardless of the volume (Input Level).
	Post Fader	Sends the effect-applied audio. The send volume can be changed by adjusting the volume (Input Level).
AUX 2 Bus This configures the AUX 2 bus.		
Send Level	-INF–10.0dB	These parameters adjust the amount of audio sent to the AUX 2 bus.
Send Point	Dry	Sends the source audio with no effects applied.
	Pre Fader	Sends the effect-applied audio. The send volume is constant, regardless of the volume (Input Level).
	Post Fader	Sends the effect-applied audio. The send volume can be changed by adjusting the volume (Input Level).
AUX 3 Bus This configures the AUX 3 bus.		
Send Level	-INF–10.0dB	These parameters adjust the amount of audio sent to the AUX 3 bus.
Send Point	Dry	Sends the source audio with no effects applied.
	Pre Fader	Sends the effect-applied audio. The send volume is constant, regardless of the volume (Input Level).
	Post Fader	Sends the effect-applied audio. The send volume can be changed by adjusting the volume (Input Level).
High Pass Filter	OFF , ON	Turns the high-pass filter on/off. Effect Cuts off unneeded low-band audio.
Frequency	20.0Hz– 80.0Hz –1.00kHz	Specifies the cutoff frequency.
Noise Gate	Turns the noise gate on/off.	
	OFF , ON	Effect Eliminates audio that is lower than the specified threshold level. This is effective when the noise that you want to remove is separate from the audio that you want to keep, and can be used to remove hiss or other noise that is heard during periods of silence.
Threshold	-80– -48 –0dB	Specifies the level used as the threshold for removing audio. Audio below the level set here is removed.
Release	30– 500 –5000msec	Adjusts the length of time until the audio is fully attenuated after audio falls below the threshold.

Menu item	Value (bold text: default value)	Explanation
Compressor	OFF , ON	Turns the compressor on/off. Effect Audio that exceeds the specified threshold level is compressed. This reduces the difference between the maximum volume and minimum volume, making the audio more comfortable for listening.
Threshold	-50-- 8 -0dB	Specifies the level used as the threshold at which the compressor is applied. Compression is applied to audio that exceeds the threshold.
Ratio	1.00: 1, 1.12: 1, 1.25: 1, 1.40: 1, 1.60: 1, 1.80: 1, 2.00: 1, 2.50: 1 , 3.20: 1, 4.00: 1, 5.60: 1, 8.00: 1, 16.0: 1, INF: 1	Specifies the degree of compression applied to the audio. The state in which no compression is applied is defined as "1".
Attack	0.0-- 30 -100msec	Specifies the time until compression starts when audio exceeding the threshold is input.
Release	30-- 250 -5000msec	Adjusts the length of time until compression ends after audio falls below the threshold.
Makeup Gain	-40-- 0 -40dB	Adjusts the final output volume level after applying the compressor.
Equalizer	OFF , ON	Turns the equalizer on/off. Effect This is a 4-band parametric equalizer. It lets you shape the character of the sound by boosting or cutting four frequency regions.
Hi Gain	-12.0-- 0.0 -12.0dB	Boosts or attenuates the high band.
Hi Freq	1.00-- 10.0 -20.0kHz	Adjusts the center frequency when changing the tone quality in the high band.
Hi-Mid Gain	-12.0-- 0.0 -12.0dB	Boosts or attenuates the high-midrange band.
Hi-Mid Freq	20.0Hz-- 2.00kHz -20.0kHz	Adjusts the center frequency when changing the tone quality in the high-midrange band.
Hi-Mid Q	0.5-- 1.0 -16.0	Adjusts the width of the frequency band when boosting or attenuating high-midrange band.
Lo-Mid Gain	-12.0-- 0.0 -12.0dB	Boosts or attenuates the low-midrange band.
Lo-Mid Freq	20.0Hz-- 500Hz -20.0kHz	Adjusts the center frequency when changing the tone quality in the low-midrange band.
Lo-Mid Q	0.5-- 1.0 -16.0	Adjusts the width of the frequency band when boosting or attenuating low-midrange band.
Lo Gain	-12.0-- 0.0 -12.0dB	Boosts or attenuates the low band.
Lo Freq	20.0Hz-- 100Hz -2.00kHz	Adjusts the center frequency when changing the tone quality in the low band.

Menu item	Value (bold text: default value)	Explanation
SDI In 1–6 Adjusts the audio that is input from the SDI IN 1–6 connectors.		
Jump To Setup	Enter	Jumps to the setup screen.
Embedded Audio Channel	1/2, 3/4, 5/6, 7/8	Selects the channel used for embedded audio.
Digital Gain	-42.0– 0.0 –42.0dB	Adjusts the digital gain.
Input Level	-INF– 0.0 –10.0dB	Adjusts the input volume.
Input Mute	OFF , ON	Turns the mute function on/off. When this is “ON”, the input audio is temporarily silenced.
Mono	Converts the input audio from stereo to mono.	
	Off	Sends the stereo input audio without change.
	L Only	The audio of the L channel is sent to both L and R.
	R Only	The audio of the R channel is sent to both L and R.
LR Mix	The audio of the L channel and R channel is mixed, and sent to both L and R.	
Solo	OFF , ON	Turns the solo function on/off. Only the audio for which this is “ON” is heard in the headphones. * The solo function applies to the headphone output. It does not affect output other than the headphones.
Delay	0.0 –500msec (0 –25.0/29.9/30.0frame)	Adjusts the delay time of the audio. Effect Outputs audio with a delay.
Reverb Send	0 –127	Adjusts the amount of audio sent to reverb.
Main Bus This configures the Main bus.		
Send	OFF, ON	When this is “ON”, audio is sent to the Main bus.
AUX 1 Bus This configures the AUX 1 bus.		
Send Level	-INF–10.0dB	These parameters adjust the amount of audio sent to the AUX 1 bus.
Send Point	Dry	Sends the source audio with no effects applied.
	Pre Fader	Sends the effect-applied audio. The send volume is constant, regardless of the volume (Input Level).
	Post Fader	Sends the effect-applied audio. The send volume can be changed by adjusting the volume (Input Level).
AUX 2 Bus This configures the AUX 2 bus.		
Send Level	-INF–10.0dB	These parameters adjust the amount of audio sent to the AUX 2 bus.
Send Point	Dry	Sends the source audio with no effects applied.
	Pre Fader	Sends the effect-applied audio. The send volume is constant, regardless of the volume (Input Level).
	Post Fader	Sends the effect-applied audio. The send volume can be changed by adjusting the volume (Input Level).
AUX 3 Bus This configures the AUX 3 bus.		
Send Level	-INF–10.0dB	These parameters adjust the amount of audio sent to the AUX 3 bus.
Send Point	Dry	Sends the source audio with no effects applied.
	Pre Fader	Sends the effect-applied audio. The send volume is constant, regardless of the volume (Input Level).
	Post Fader	Sends the effect-applied audio. The send volume can be changed by adjusting the volume (Input Level).
High Pass Filter	OFF , ON	Turns the high-pass filter on/off. Effect Cuts off unneeded low-band audio.
Frequency	20.0Hz– 80.0Hz –1.00kHz	Specifies the cutoff frequency.
Noise Gate	Turns the noise gate on/off.	
	OFF , ON	Effect Eliminates audio that is lower than the specified threshold level. This is effective when the noise that you want to remove is separate from the audio that you want to keep, and can be used to remove hiss or other noise that is heard during periods of silence.
Threshold	-80– -48 –0dB	Specifies the level used as the threshold for removing audio. Audio below the level set here is removed.
Release	30– 500 –5000msec	Adjusts the length of time until the audio is fully attenuated after audio falls below the threshold.

Menu item	Value (bold text: default value)	Explanation
Compressor	OFF , ON	Turns the compressor on/off. Effect Audio that exceeds the specified threshold level is compressed. This reduces the difference between the maximum volume and minimum volume, making the audio more comfortable for listening.
Threshold	-50-- 8 -0dB	Specifies the level used as the threshold at which the compressor is applied. Compression is applied to audio that exceeds the threshold.
Ratio	1.00: 1, 1.12: 1, 1.25: 1, 1.40: 1, 1.60: 1, 1.80: 1, 2.00: 1, 2.50: 1 , 3.20: 1, 4.00: 1, 5.60: 1, 8.00: 1, 16.0: 1, INF: 1	Specifies the degree of compression applied to the audio. The state in which no compression is applied is defined as "1".
Attack	0.0-- 30 -100msec	Specifies the time until compression starts when audio exceeding the threshold is input.
Release	30-- 250 -5000msec	Adjusts the length of time until compression ends after audio falls below the threshold.
Makeup Gain	-40-- 0 -40dB	Adjusts the final output volume level after applying the compressor.
Equalizer	OFF , ON	Turns the equalizer on/off. Effect This is a 4-band parametric equalizer. It lets you shape the character of the sound by boosting or cutting four frequency regions.
Hi Gain	-12.0-- 0.0 -12.0dB	Boosts or attenuates the high band.
Hi Freq	1.00-- 10.0 -20.0kHz	Adjusts the center frequency when changing the tone quality in the high band.
Hi-Mid Gain	-12.0-- 0.0 -12.0dB	Boosts or attenuates the high-midrange band.
Hi-Mid Freq	20.0Hz-- 2.00kHz -20.0kHz	Adjusts the center frequency when changing the tone quality in the high-midrange band.
Hi-Mid Q	0.5-- 1.0 -16.0	Adjusts the width of the frequency band when boosting or attenuating high-midrange band.
Lo-Mid Gain	-12.0-- 0.0 -12.0dB	Boosts or attenuates the low-midrange band.
Lo-Mid Freq	20.0Hz-- 500Hz -20.0kHz	Adjusts the center frequency when changing the tone quality in the low-midrange band.
Lo-Mid Q	0.5-- 1.0 -16.0	Adjusts the width of the frequency band when boosting or attenuating low-midrange band.
Lo Gain	-12.0-- 0.0 -12.0dB	Boosts or attenuates the low band.
Lo Freq	20.0Hz-- 100Hz -2.00kHz	Adjusts the center frequency when changing the tone quality in the low band.

Menu item	Value (bold text: default value)	Explanation
Video Player/SRT In	Adjusts the audio input from the video player/SRT input.	
Jump To Setup	Enter	Jumps to the setup screen.
Digital Gain	-42.0- 0.0 -42.0dB	Adjusts the digital gain.
Input Level	-INF- 0.0 -10.0dB	Adjusts the input volume.
Input Mute	OFF , ON	Turns the mute function on/off. When this is "ON", the input audio is temporarily silenced.
Mono	Converts the input audio from stereo to mono.	
	Off	Sends the stereo input audio without change.
	L Only	The audio of the L channel is sent to both L and R.
	R Only	The audio of the R channel is sent to both L and R.
LR Mix	The audio of the L channel and R channel is mixed, and sent to both L and R.	
Solo	OFF , ON	Turns the solo function on/off. Only the audio for which this is "ON" is heard in the headphones. * The solo function applies to the headphone output. It does not affect output other than the headphones.
Delay	0.0 -500msec (0 -25.0/29.9/30.0frame)	Adjusts the delay time of the audio. Effect Outputs audio with a delay.
Reverb Send	0 -127	Adjusts the amount of audio sent to reverb.
Main Bus	This configures the Main bus.	
Send	OFF, ON	When this is "ON", audio is sent to the Main bus.
AUX 1 Bus	This configures the AUX 1 bus.	
Send Level	-INF-10.0dB	These parameters adjust the amount of audio sent to the AUX 1 bus.
Send Point	Dry	Sends the source audio with no effects applied.
	Pre Fader	Sends the effect-applied audio. The send volume is constant, regardless of the volume (Input Level).
	Post Fader	Sends the effect-applied audio. The send volume can be changed by adjusting the volume (Input Level).
AUX 2 Bus	This configures the AUX 2 bus.	
Send Level	-INF-10.0dB	These parameters adjust the amount of audio sent to the AUX 2 bus.
Send Point	Dry	Sends the source audio with no effects applied.
	Pre Fader	Sends the effect-applied audio. The send volume is constant, regardless of the volume (Input Level).
	Post Fader	Sends the effect-applied audio. The send volume can be changed by adjusting the volume (Input Level).
AUX 3 Bus	This configures the AUX 3 bus.	
Send Level	-INF-10.0dB	These parameters adjust the amount of audio sent to the AUX 3 bus.
Send Point	Dry	Sends the source audio with no effects applied.
	Pre Fader	Sends the effect-applied audio. The send volume is constant, regardless of the volume (Input Level).
	Post Fader	Sends the effect-applied audio. The send volume can be changed by adjusting the volume (Input Level).
High Pass Filter	OFF , ON	Turns the high-pass filter on/off. Effect Cuts off unneeded low-band audio.
Frequency	20.0Hz- 80.0Hz -1.00kHz	Specifies the cutoff frequency.
Noise Gate	OFF , ON	Turns the noise gate on/off. Effect Eliminates audio that is lower than the specified threshold level. This is effective when the noise that you want to remove is separate from the audio that you want to keep, and can be used to remove hiss or other noise that is heard during periods of silence.
Threshold	-80- -48 -0dB	Specifies the level used as the threshold for removing audio. Audio below the level set here is removed.
Release	30- 500 -5000msec	Adjusts the length of time until the audio is fully attenuated after audio falls below the threshold.

Menu item	Value (bold text: default value)	Explanation
Compressor	OFF , ON	Turns the compressor on/off. Effect Audio that exceeds the specified threshold level is compressed. This reduces the difference between the maximum volume and minimum volume, making the audio more comfortable for listening.
Threshold	-50-- 8 -0dB	Specifies the level used as the threshold at which the compressor is applied. Compression is applied to audio that exceeds the threshold.
Ratio	1.00: 1, 1.12: 1, 1.25: 1, 1.40: 1, 1.60: 1, 1.80: 1, 2.00: 1, 2.50: 1 , 3.20: 1, 4.00: 1, 5.60: 1, 8.00: 1, 16.0: 1, INF: 1	Specifies the degree of compression applied to the audio. The state in which no compression is applied is defined as "1".
Attack	0.0-- 30 -100msec	Specifies the time until compression starts when audio exceeding the threshold is input.
Release	30-- 250 -5000msec	Adjusts the length of time until compression ends after audio falls below the threshold.
Makeup Gain	-40-- 0 -40dB	Adjusts the final output volume level after applying the compressor.
Equalizer	OFF , ON	Turns the equalizer on/off. Effect This is a 4-band parametric equalizer. It lets you shape the character of the sound by boosting or cutting four frequency regions.
Hi Gain	-12.0-- 0.0 -12.0dB	Boosts or attenuates the high band.
Hi Freq	1.00-- 10.0 -20.0kHz	Adjusts the center frequency when changing the tone quality in the high band.
Hi-Mid Gain	-12.0-- 0.0 -12.0dB	Boosts or attenuates the high-midrange band.
Hi-Mid Freq	20.0Hz-- 2.00kHz -20.0kHz	Adjusts the center frequency when changing the tone quality in the high-midrange band.
Hi-Mid Q	0.5-- 1.0 -16.0	Adjusts the width of the frequency band when boosting or attenuating high-midrange band.
Lo-Mid Gain	-12.0-- 0.0 -12.0dB	Boosts or attenuates the low-midrange band.
Lo-Mid Freq	20.0Hz-- 500Hz -20.0kHz	Adjusts the center frequency when changing the tone quality in the low-midrange band.
Lo-Mid Q	0.5-- 1.0 -16.0	Adjusts the width of the frequency band when boosting or attenuating low-midrange band.
Lo Gain	-12.0-- 0.0 -12.0dB	Boosts or attenuates the low band.
Lo Freq	20.0Hz-- 100Hz -2.00kHz	Adjusts the center frequency when changing the tone quality in the low band.

9: Audio Output

Menu item	Value (bold text: default value)	Explanation
Output Assign	Specifies the audio bus that is assigned to each connector.	
Jump To Setup	Enter	Jumps to the setup screen.
Audio Out 1 (XLR)	Main Bus , AUX 1 Bus, AUX 2 Bus, AUX 3 Bus, Monitor Bus	<p>Main Bus: All input audio is mixed and output (master output).</p> <p>AUX 1 Bus, AUX 2 Bus, AUX 3 Bus: Only the input audio sent to the AUX bus is mixed and output. This allows you to output audio that is different than the master output.</p> <p>Monitor Bus: This outputs the same audio as what you hear in the headphones.</p>
Audio Out 2 (XLR)	Main Bus , AUX 1 Bus, AUX 2 Bus, AUX 3 Bus, Monitor Bus	
Audio Out 3 (RCA)	Main Bus , AUX 1 Bus, AUX 2 Bus, AUX 3 Bus, Monitor Bus	
Phones Out/Monitor	Main Bus , AUX 1 Bus, AUX 2 Bus, AUX 3 Bus	
USB Out	Main Bus , AUX 1 Bus, AUX 2 Bus, AUX 3 Bus	
Stream/Record	Main Bus , AUX 1 Bus, AUX 2 Bus, AUX 3 Bus	
Audio Record	Main Bus , AUX 1 Bus, AUX 2 Bus, AUX 3 Bus	
HDMI Out 1–3	Main Bus , AUX 1 Bus, AUX 2 Bus, AUX 3 Bus, Monitor Bus	
SDI Out 1–3	Main Bus , AUX 1 Bus, AUX 2 Bus, AUX 3 Bus, Monitor Bus	
Main Bus	Adjusts the audio of the MAIN bus.	
Jump To Setup	Enter	Jumps to the setup screen.
Level	-INF- 0.0 -10.0dB	Adjusts the output volume. This can also be adjusted by the [MAIN] fader.
Mute	OFF , ON	Turns the mute function on/off. When this is "ON", the input audio is temporarily silenced.
Solo	OFF , ON	Turns the solo function on/off. Only the audio for which this is "ON" is heard in the headphones. * The solo function applies to the headphone output. It does not affect output other than the headphones.
Delay	0.0 -500msec (0 -25.0/29.9/30.0frame)	Adjusts the delay time of the audio. Effect Outputs audio with a delay.
Reverb	OFF , ON	Turns reverb on/off. Effect Adds reverberation to the sound.
Level	0 -127	This adjusts the depth of the overall reverb.
Type	Specifies the reverb type.	
Room	Room	Produces the natural-sounding reverberation of a room.
Hall	Hall	Produces the reverberation that is typical of a performance in a concert hall.
Size	1- 10 -20	Specifies the size of the room. The larger the value, the longer the reverb time.
Return Level	-INF- 0.0 -10.0dB	Adjusts how much reverb is sent back to the main bus.
Equalizer	OFF , ON	Turns the equalizer on/off. Effect This is a 4-band parametric equalizer. It lets you shape the character of the sound by boosting or cutting four frequency regions.
Hi Gain	-12.0- 0.0 -12.0dB	Boosts or attenuates the high band.
Hi Freq	1.00- 10.0 -20.0kHz	Adjusts the center frequency when changing the tone quality in the high band.
Hi-Mid Gain	-12.0- 0.0 -12.0dB	Boosts or attenuates the high-midrange band.
Hi-Mid Freq	20.0Hz- 2.00kHz -20.0kHz	Adjusts the center frequency when changing the tone quality in the high-midrange band.
Hi-Mid Q	0.5- 1.0 -16.0	Adjusts the width of the frequency band when boosting or attenuating high-midrange band.
Lo-Mid Gain	-12.0- 0.0 -12.0dB	Boosts or attenuates the low-midrange band.
Lo-Mid Freq	20.0Hz- 500Hz -20.0kHz	Adjusts the center frequency when changing the tone quality in the low-midrange band.
Lo-Mid Q	0.5- 1.0 -16.0	Adjusts the width of the frequency band when boosting or attenuating low-midrange band.
Lo Gain	-12.0- 0.0 -12.0dB	Boosts or attenuates the low band.
Lo Freq	20.0Hz- 100Hz -2.00kHz	Adjusts the center frequency when changing the tone quality in the low band.

Menu item	Value (bold text: default value)	Explanation
Compressor/Limiter	OFF , ON	Turns the compressor or limiter on/off.
Type	Selects the compressor or limiter.	
	Compressor	Effect Audio that exceeds the specified threshold level is compressed. This reduces the difference between the maximum volume and minimum volume, making the audio more comfortable for listening
	Limiter	Effect Compresses the audio so that the mixed audio does not exceed the specified threshold level. * Distortion will occur if audio that exceeds the allowable range of the limiter is input.
Compressor		
Threshold	-50-- 8 -0dB	Specifies the level used as the threshold at which the compressor is applied. Compression is applied to audio that exceeds the threshold.
Ratio	1.00: 1, 1.12: 1, 1.25: 1, 1.40: 1, 1.60: 1, 1.80: 1, 2.00: 1, 2.50: 1 , 3.20: 1, 4.00: 1, 5.60: 1, 8.00: 1, 16.0: 1, INF: 1	Specifies the degree of compression applied to the audio. The state in which no compression is applied is defined as "1".
Attack	0.0- 30 -100ms	Specifies the time until compression starts when audio exceeding the threshold is input.
Release	30- 250 -5000ms	Adjusts the length of time until compression ends after audio falls below the threshold.
Makeup Gain	-40- 0 -40dB	Adjusts the final output volume level after applying the compressor.
Limiter		
Threshold	-40-- 6 -0dB	Adjusts the level that becomes the threshold at which the limiter is applied. Compression is applied to audio that exceeds the threshold. The volume level of audio that is output is limited so as to stay to below the threshold.
Loudness Auto Gain Control	OFF , ON	Turns loudness auto gain control on/off. Effect The long-term average loudness is measured, and the volume is adjusted so that it is appropriate overall.
Integrated Gain Control	Disable, Enable	Specifies whether the extended interval auto control is enabled (Enable) or disabled (Disable).
Sens	0- 80 -127	Adjusts the speed at which the target level (Target LKFS) is approached.
Momentary Gain Control	Disable, Enable	Specifies whether the momentary auto control is enabled (Enable) or disabled (Disable).
Sens	0- 80 -127	Adjusts the speed at which the target level (Target LKFS) is approached.
Target LKFS	-34- -24 -10dB	Specifies the target loudness value.
Forget Learning	Exec	Resets the learned parameters. Reset applies to the parameters of loudness auto gain control.
Adaptive Noise Reduction	OFF , ON	Turns Adaptive Noise Reduction on/off. Effect By continuously monitoring the input audio to detect noise during periods of silence, this removes only the noise component.
Depth	0- 80 -127	Specifies the strength at which noise reduction is applied.
Talking Detector	0- 80 -127	Specifies the sensitivity of the talking detector. Higher values raise the sensitivity, so that it will be easier to detect the presence or absence of talking even in a noisy environment.
Auto Learn	Disable, Enable	Enables automatic noise detection.
Manual Measure	Exec	Performs noise detection manually.
Forget Learning	Exec	Resets the learned parameters. Reset applies to the parameters of adaptive noise reduction.
Lo Frequency Cut	OFF , ON	Turns Lo Frequency Cut on/off.
GEQ	OFF , ON	These are the settings for the graphic equalizer. Effect It lets you shape the character of the sound by boosting or cutting each of the 15 frequency regions into which the sound is divided.
All Flat	Exec	Sets the equalizer settings to flat (0.0 dB).
25Hz	-15.0- 0.0 +15.0dB	Boost/cut each frequency region.
40Hz		
60Hz		
100Hz		
160Hz		
250Hz		
400Hz		
630Hz		
1kHz		
1.6kHz		
2.5kHz		
4kHz		
6.3kHz		
10kHz		
16kHz		

Menu item	Value (bold text: default value)	Explanation
AUX 1 Bus Adjusts the audio of the AUX 1 bus.		
Jump To Setup	Enter	Jumps to the setup screen.
Level	-INF- 0.0 -10.0dB	Adjusts the output volume. This can also be adjusted by the [AUX 1] knob.
Mute	OFF , ON	Turns the mute function on/off. When this is "ON", the input audio is temporarily silenced.
Solo	OFF , ON	Turns the solo function on/off. Only the audio for which this is "ON" is heard in the headphones. * The solo function applies to the headphone output. It does not affect output other than the headphones.
Delay	0.0 -500msec (0 -25.0/29.9/30.0frame)	Adjusts the delay time of the audio. Effect Outputs audio with a delay.
Reverb Return Level	-INF- 0.0 -10.0dB	Adjusts how much reverb is sent back to the AUX 1 Bus.
AUX 1 Bus Send Level		
Audio In 1-6	-INF -10.0dB	Adjusts the amount of audio sent to the AUX bus for each audio input.
Audio In 7/8-9/10		
USB In		
Bluetooth In		
Audio Player		
HDMI In 1-6		
SDI In 1-6		
Video Player/SRT In		
AUX 1 Bus Send Point		
Audio In 1-6	Dry, Pre Fader , Post Fader	Dry: Sends the source audio with no effects applied. Pre Fader: Sends the effect-applied audio. The send volume is constant, regardless of the volume (Input Level). Post Fader: Sends the effect-applied audio. The send volume can be changed by adjusting the volume (Input Level).
Audio In 7/8-9/10		
USB In		
Bluetooth In		
Audio Player		
HDMI In 1-6		
SDI In 1-6		
Video Player/SRT In		
Equalizer	OFF , ON	Turns the equalizer on/off. Effect This is a 4-band parametric equalizer. It lets you shape the character of the sound by boosting or cutting four frequency regions.
Hi Gain	-12.0- 0.0 -12.0dB	Boosts or attenuates the high band.
Hi Freq	1.00- 10.0 -20.0kHz	Adjusts the center frequency when changing the tone quality in the high band.
Hi-Mid Gain	-12.0- 0.0 -12.0dB	Boosts or attenuates the high-midrange band.
Hi-Mid Freq	20.0Hz- 2.00kHz -20.0kHz	Adjusts the center frequency when changing the tone quality in the high-midrange band.
Hi-Mid Q	0.5- 1.0 -16.0	Adjusts the width of the frequency band when boosting or attenuating high-midrange band.
Lo-Mid Gain	-12.0- 0.0 -12.0dB	Boosts or attenuates the low-midrange band.
Lo-Mid Freq	20.0Hz- 500Hz -20.0kHz	Adjusts the center frequency when changing the tone quality in the low-midrange band.
Lo-Mid Q	0.5- 1.0 -16.0	Adjusts the width of the frequency band when boosting or attenuating low-midrange band.
Lo Gain	-12.0- 0.0 -12.0dB	Boosts or attenuates the low band.
Lo Freq	20.0Hz- 100Hz -2.00kHz	Adjusts the center frequency when changing the tone quality in the low band.

Menu List

Menu item	Value (bold text: default value)	Explanation
Compressor/Limiter	OFF , ON	Turns the compressor or limiter on/off.
Type	Selects the compressor or limiter.	
	Compressor	Effect Audio that exceeds the specified threshold level is compressed. This reduces the difference between the maximum volume and minimum volume, making the audio more comfortable for listening
	Limiter	Effect Compresses the audio so that the mixed audio does not exceed the specified threshold level. * Distortion will occur if audio that exceeds the allowable range of the limiter is input.
Compressor		
Threshold	-50-- 8 -0dB	Specifies the level used as the threshold at which the compressor is applied. Compression is applied to audio that exceeds the threshold.
Ratio	1.00: 1, 1.12: 1, 1.25: 1, 1.40: 1, 1.60: 1, 1.80: 1, 2.00: 1, 2.50: 1 , 3.20: 1, 4.00: 1, 5.60: 1, 8.00: 1, 16.0: 1, INF: 1	Specifies the degree of compression applied to the audio. The state in which no compression is applied is defined as "1".
Attack	0.0- 30 -100ms	Specifies the time until compression starts when audio exceeding the threshold is input.
Release	30- 250 -5000ms	Adjusts the length of time until compression ends after audio falls below the threshold.
Makeup Gain	-40- 0 -40dB	Adjusts the final output volume level after applying the compressor.
Limiter		
Threshold	-40-- 6 -0dB	Adjusts the level that becomes the threshold at which the limiter is applied. Compression is applied to audio that exceeds the threshold. The volume level of audio that is output is limited so as to stay to below the threshold.
GEQ	OFF , ON	These are the settings for the graphic equalizer. Effect It lets you shape the character of the sound by boosting or cutting each of the 15 frequency regions into which the sound is divided.
All Flat	Exec	Sets the equalizer settings to flat (0.0 dB).
25Hz	-15.0-- 0.0 +15.0dB	Boost/cut each frequency region.
40Hz		
60Hz		
100Hz		
160Hz		
250Hz		
400Hz		
630Hz		
1kHz		
1.6kHz		
2.5kHz		
4kHz		
6.3kHz		
10kHz		
16kHz		

Menu item	Value (bold text: default value)	Explanation
AUX 2 Bus Adjusts the audio of the AUX 2 bus.		
Jump To Setup	Enter	Jumps to the setup screen.
Level	-INF- 0.0 -10.0dB	Adjusts the output volume. This can also be adjusted by the [AUX 2] knob.
Mute	OFF , ON	Turns the mute function on/off. When this is "ON", the input audio is temporarily silenced.
Solo	OFF , ON	Turns the solo function on/off. Only the audio for which this is "ON" is heard in the headphones. * The solo function applies to the headphone output. It does not affect output other than the headphones.
Delay	0.0 -500msec (0 -25.0/29.9/30.0frame)	Adjusts the delay time of the audio. Effect Outputs audio with a delay.
Reverb Return Level	-INF- 0.0 -10.0dB	Adjusts how much reverb is sent back to the AUX 2 Bus.
AUX 2 Bus Send Level		
Audio In 1-6	-INF -10.0dB	Adjusts the amount of audio sent to the AUX bus for each audio input.
Audio In 7/8-9/10		
USB In		
Bluetooth In		
Audio Player		
HDMI In 1-6		
SDI In 1-6		
Video Player/SRT In		
AUX 2 Bus Send Point		
Audio In 1-6	Dry, Pre Fader , Post Fader	Dry: Sends the source audio with no effects applied. Pre Fader: Sends the effect-applied audio. The send volume is constant, regardless of the volume (Input Level). Post Fader: Sends the effect-applied audio. The send volume can be changed by adjusting the volume (Input Level).
Audio In 7/8-9/10		
USB In		
Bluetooth In		
Audio Player		
HDMI In 1-6		
SDI In 1-6		
Video Player/SRT In		
Equalizer	OFF , ON	Turns the equalizer on/off. Effect This is a 4-band parametric equalizer. It lets you shape the character of the sound by boosting or cutting four frequency regions.
Hi Gain	-12.0- 0.0 -12.0dB	Boosts or attenuates the high band.
Hi Freq	1.00- 10.0 -20.0kHz	Adjusts the center frequency when changing the tone quality in the high band.
Hi-Mid Gain	-12.0- 0.0 -12.0dB	Boosts or attenuates the high-midrange band.
Hi-Mid Freq	20.0Hz- 2.00kHz -20.0kHz	Adjusts the center frequency when changing the tone quality in the high-midrange band.
Hi-Mid Q	0.5- 1.0 -16.0	Adjusts the width of the frequency band when boosting or attenuating high-midrange band.
Lo-Mid Gain	-12.0- 0.0 -12.0dB	Boosts or attenuates the low-midrange band.
Lo-Mid Freq	20.0Hz- 500Hz -20.0kHz	Adjusts the center frequency when changing the tone quality in the low-midrange band.
Lo-Mid Q	0.5- 1.0 -16.0	Adjusts the width of the frequency band when boosting or attenuating low-midrange band.
Lo Gain	-12.0- 0.0 -12.0dB	Boosts or attenuates the low band.
Lo Freq	20.0Hz- 100Hz -2.00kHz	Adjusts the center frequency when changing the tone quality in the low band.

Menu List

Menu item	Value (bold text: default value)	Explanation
Compressor/Limiter	OFF , ON	Turns the compressor or limiter on/off.
Type	Selects the compressor or limiter.	
	Compressor	<p>Effect Audio that exceeds the specified threshold level is compressed. This reduces the difference between the maximum volume and minimum volume, making the audio more comfortable for listening</p>
	Limiter	<p>Effect Compresses the audio so that the mixed audio does not exceed the specified threshold level.</p> <p>* Distortion will occur if audio that exceeds the allowable range of the limiter is input.</p>
Compressor		
Threshold	-50-- 8 -0dB	Specifies the level used as the threshold at which the compressor is applied. Compression is applied to audio that exceeds the threshold.
Ratio	1.00: 1, 1.12: 1, 1.25: 1, 1.40: 1, 1.60: 1, 1.80: 1, 2.00: 1, 2.50: 1 , 3.20: 1, 4.00: 1, 5.60: 1, 8.00: 1, 16.0: 1, INF: 1	Specifies the degree of compression applied to the audio. The state in which no compression is applied is defined as "1".
Attack	0.0-- 30 -100ms	Specifies the time until compression starts when audio exceeding the threshold is input.
Release	30-- 250 -5000ms	Adjusts the length of time until compression ends after audio falls below the threshold.
Makeup Gain	-40-- 0 -40dB	Adjusts the final output volume level after applying the compressor.
Limiter		
Threshold	-40-- 6 -0dB	Adjusts the level that becomes the threshold at which the limiter is applied. Compression is applied to audio that exceeds the threshold. The volume level of audio that is output is limited so as to stay to below the threshold.
GEQ	OFF , ON	<p>These are the settings for the graphic equalizer.</p> <p>Effect It lets you shape the character of the sound by boosting or cutting each of the 15 frequency regions into which the sound is divided.</p>
All Flat	Exec	Sets the equalizer settings to flat (0.0 dB).
25Hz	-15.0-- 0.0 --15.0dB	Boost/cut each frequency region.
40Hz		
60Hz		
100Hz		
160Hz		
250Hz		
400Hz		
630Hz		
1kHz		
1.6kHz		
2.5kHz		
4kHz		
6.3kHz		
10kHz		
16kHz		

Menu item	Value (bold text: default value)	Explanation
AUX 3 Bus Adjusts the audio of the AUX 3 bus.		
Jump To Setup	Enter	Jumps to the setup screen.
Level	-INF- 0.0 -10.0dB	Adjusts the output volume.
Mute	OFF , ON	Turns the mute function on/off. When this is "ON", the input audio is temporarily silenced.
Solo	OFF , ON	Turns the solo function on/off. Only the audio for which this is "ON" is heard in the headphones. * The solo function applies to the headphone output. It does not affect output other than the headphones.
Delay	0.0 -500msec (0 -25.0/29.9/30.0frame)	Adjusts the delay time of the audio. Effect Outputs audio with a delay.
Reverb Return Level	-INF- 0.0 -10.0dB	Adjusts how much reverb is sent back to the AUX 3 Bus.
AUX 3 Bus Send Level		
Audio In 1-6	-INF -10.0dB	Adjusts the amount of audio sent to the AUX bus for each audio input.
Audio In 7/8-9/10		
USB In		
Bluetooth In		
Audio Player		
HDMI In 1-6		
SDI In 1-6		
Video Player/SRT In		
AUX 3 Bus Send Point		
Audio In 1-6	Dry, Pre Fader , Post Fader	Dry: Sends the source audio with no effects applied. Pre Fader: Sends the effect-applied audio. The send volume is constant, regardless of the volume (Input Level). Post Fader: Sends the effect-applied audio. The send volume can be changed by adjusting the volume (Input Level).
Audio In 7/8-9/10		
USB In		
Bluetooth In		
Audio Player		
HDMI In 1-6		
SDI In 1-6		
Video Player/SRT In		
Equalizer		
	OFF , ON	Turns the equalizer on/off. Effect This is a 4-band parametric equalizer. It lets you shape the character of the sound by boosting or cutting four frequency regions.
Hi Gain	-12.0- 0.0 -12.0dB	Boosts or attenuates the high band.
Hi Freq	1.00- 10.0 -20.0kHz	Adjusts the center frequency when changing the tone quality in the high band.
Hi-Mid Gain	-12.0- 0.0 -12.0dB	Boosts or attenuates the high-midrange band.
Hi-Mid Freq	20.0Hz- 2.00kHz -20.0kHz	Adjusts the center frequency when changing the tone quality in the high-midrange band.
Hi-Mid Q	0.5- 1.0 -16.0	Adjusts the width of the frequency band when boosting or attenuating high-midrange band.
Lo-Mid Gain	-12.0- 0.0 -12.0dB	Boosts or attenuates the low-midrange band.
Lo-Mid Freq	20.0Hz- 500Hz -20.0kHz	Adjusts the center frequency when changing the tone quality in the low-midrange band.
Lo-Mid Q	0.5- 1.0 -16.0	Adjusts the width of the frequency band when boosting or attenuating low-midrange band.
Lo Gain	-12.0- 0.0 -12.0dB	Boosts or attenuates the low band.
Lo Freq	20.0Hz- 100Hz -2.00kHz	Adjusts the center frequency when changing the tone quality in the low band.
Compressor/Limiter		
	OFF , ON	Turns the compressor or limiter on/off.
Selects the compressor or limiter.		
Type	Compressor	Effect Audio that exceeds the specified threshold level is compressed. This reduces the difference between the maximum volume and minimum volume, making the audio more comfortable for listening
	Limiter	Effect Compresses the audio so that the mixed audio does not exceed the specified threshold level. * Distortion will occur if audio that exceeds the allowable range of the limiter is input.
Compressor		
Threshold	-50- -8 -0dB	Specifies the level used as the threshold at which the compressor is applied. Compression is applied to audio that exceeds the threshold.
Ratio	1.00: 1, 1.12: 1, 1.25: 1, 1.40: 1, 1.60: 1, 1.80: 1, 2.00: 1, 2.50: 1 , 3.20: 1, 4.00: 1, 5.60: 1, 8.00: 1, 16.0: 1, INF: 1	Specifies the degree of compression applied to the audio. The state in which no compression is applied is defined as "1".
Attack	0.0- 30 -100ms	Specifies the time until compression starts when audio exceeding the threshold is input.
Release	30- 250 -5000ms	Adjusts the length of time until compression ends after audio falls below the threshold.
Makeup Gain	-40- 0 -40dB	Adjusts the final output volume level after applying the compressor.
Limiter		

Menu List

Menu item	Value (bold text: default value)	Explanation
Threshold	-40-- 6 -0dB	Adjusts the level that becomes the threshold at which the limiter is applied. Compression is applied to audio that exceeds the threshold. The volume level of audio that is output is limited so as to stay to below the threshold.
GEQ	OFF , ON	These are the settings for the graphic equalizer. Effect It lets you shape the character of the sound by boosting or cutting each of the 15 frequency regions into which the sound is divided.
All Flat	Exec	Sets the equalizer settings to flat (0.0 dB).
25Hz	-15.0- 0.0 +15.0dB	Boost/cut each frequency region.
40Hz		
60Hz		
100Hz		
160Hz		
250Hz		
400Hz		
630Hz		
1kHz		
1.6kHz		
2.5kHz		
4kHz		
6.3kHz		
10kHz		
16kHz		
Phones Out/Monitor	Adjusts the audio that is output from the PHONES jack.	
Jump To Setup	Enter	Jumps to the setup screen.
Phones Level	- INF -10.0dB	Adjusts the output volume. This can also be adjusted by the [PHONES] knob.
Monitor Mute	OFF , ON	Turns the mute function on/off. When this is "ON", the input audio is temporarily silenced.
Monitor Level	- INF -10.0dB	Adjust the monitor volume.
USB Out	Adjusts the audio that's output from the USB STREAM port.	
Jump To Setup	Enter	Jumps to the setup screen.
Level	-INF- 0.0 -10.0dB	Adjusts the output volume. This can also be adjusted by the [USB OUT] knob.
Mute	OFF , ON	Turns the mute function on/off. When this is "ON", the input audio is temporarily silenced.
Delay	0.0 -500msec (0 -25.0/29.9/30.0frame)	Adjusts the delay time of the audio. Effect Outputs audio with a delay.
Equalizer	OFF , ON	Turns the equalizer on/off. Effect This is a 4-band parametric equalizer. It lets you shape the character of the sound by boosting or cutting four frequency regions.
Hi Gain	-12.0- 0.0 -12.0dB	Boosts or attenuates the high band.
Hi Freq	1.00- 10.0 -20.0kHz	Adjusts the center frequency when changing the tone quality in the high band.
Hi-Mid Gain	-12.0- 0.0 -12.0dB	Boosts or attenuates the high-midrange band.
Hi-Mid Freq	20.0Hz- 2.00kHz -20.0kHz	Adjusts the center frequency when changing the tone quality in the high-midrange band.
Hi-Mid Q	0.5- 1.0 -16.0	Adjusts the width of the frequency band when boosting or attenuating high-midrange band.
Lo-Mid Gain	-12.0- 0.0 -12.0dB	Boosts or attenuates the low-midrange band.
Lo-Mid Freq	20.0Hz- 500Hz -20.0kHz	Adjusts the center frequency when changing the tone quality in the low-midrange band.
Lo-Mid Q	0.5- 1.0 -16.0	Adjusts the width of the frequency band when boosting or attenuating low-midrange band.
Lo Gain	-12.0- 0.0 -12.0dB	Boosts or attenuates the low band.
Lo Freq	20.0Hz- 100Hz -2.00kHz	Adjusts the center frequency when changing the tone quality in the low band.

Menu item	Value (bold text: default value)	Explanation
Stream/Record	Adjusts the audio that's output from the DIRECT STREAM port.	
Jump To Setup	Enter	Jumps to the setup screen.
Level	-INF- 0.0 -10.0dB	Adjusts the output volume. This can also be adjusted by the [STREAM/RECORD] knob.
Mute	OFF , ON	Turns the mute function on/off. When this is "ON", the input audio is temporarily silenced.
Delay	0.0 -500msec (0 -25.0/29.9/30.0frame)	Adjusts the delay time of the audio. Effect Outputs audio with a delay.
Equalizer	OFF , ON	Turns the equalizer on/off. Effect This is a 4-band parametric equalizer. It lets you shape the character of the sound by boosting or cutting four frequency regions.
Hi Gain	-12.0- 0.0 -12.0dB	Boosts or attenuates the high band.
Hi Freq	1.00- 10.0 -20.0kHz	Adjusts the center frequency when changing the tone quality in the high band.
Hi-Mid Gain	-12.0- 0.0 -12.0dB	Boosts or attenuates the high-midrange band.
Hi-Mid Freq	20.0Hz- 2.00kHz -20.0kHz	Adjusts the center frequency when changing the tone quality in the high-midrange band.
Hi-Mid Q	0.5- 1.0 -16.0	Adjusts the width of the frequency band when boosting or attenuating high-midrange band.
Lo-Mid Gain	-12.0- 0.0 -12.0dB	Boosts or attenuates the low-midrange band.
Lo-Mid Freq	20.0Hz- 500Hz -20.0kHz	Adjusts the center frequency when changing the tone quality in the low-midrange band.
Lo-Mid Q	0.5- 1.0 -16.0	Adjusts the width of the frequency band when boosting or attenuating low-midrange band.
Lo Gain	-12.0- 0.0 -12.0dB	Boosts or attenuates the low band.
Lo Freq	20.0Hz- 100Hz -2.00kHz	Adjusts the center frequency when changing the tone quality in the low band.
HDMI/SDI Audio Embedded	Settings related to embedded audio for the HDMI/SDI output.	
HDMI Out 1-3 Send	These parameters set the input audio to send to HDMI embedded audio channels 3-8.	
Channel 3/4	N/A , Audio In 1/2-Audio In 9/10,	When this is set to "N/A", no audio is sent.
Channel 5/6	USB In, Bluetooth In, Audio Player,	* The following audio buses are assigned for channels 1 and 2.
Channel 7/8	HDMI 1-6, SDI 1-6, Video Player/SRT In	Channel 1: Main Bus (L) or AUX 1 Bus (L) Channel 2: Main Bus (R) or AUX 2 Bus (R)
SDI Out 1-3 Send	These parameters set the input audio to send to SDI embedded audio channels 3-8.	
Channel 3/4	N/A , Audio In 1/2-Audio In 9/10,	When this is set to "N/A", no audio is sent.
Channel 5/6	USB In, Bluetooth In, Audio Player,	* The following audio buses are assigned for channels 1 and 2.
Channel 7/8	HDMI 1-6, SDI 1-6, Video Player/SRT In	Channel 1: Main Bus (L) or AUX 1 Bus (L) Channel 2: Main Bus (R) or AUX 2 Bus (R)
Audio In 1-9/10 USB In Bluetooth In Audio Player HDMI In 1-6 SDI In 1-6 Video Player/SRT In	Sets whether to send audio with effects applied, from each input to the HDMI/SDI embedded audio channels (3-8).	
	Off	Audio is not sent.
	Dry	Sends the source audio with no effects applied.
	Pre Fader	Sends the effect-applied audio. The send volume is constant, regardless of the volume (Input Level).
	Post Fader	Sends the effect-applied audio. The send volume can be changed by adjusting the volume (Input Level).

10: Audio Follow

Menu item	Value (bold text: default value)	Explanation
All	All Off, All On	Turns on/off the audio follow function for HDMI 1–6, SDI 1–6, and Video Player/SRT In in a single action.
HDMI In 1–6 SDI In 1–6 Video Player/SRT In	Turns the audio follow function on/off. Audio follow is a function that automatically switches the audio output in tandem with video switching.	
	OFF	The audio is always output regardless of the video selection.
	ON	The audio is output only when the video is selected. The audio is automatically muted if another video is selected.
Audio in 1–9/10	Off , HDMI 1–6, SDI 1–6, Still 1–16, V.Player/SRT In (*21), Input 1–8	For each audio source, these settings specify the input video (Input 1–8) that will use the audio follow function. Audio is output only when the specified input video is selected. When this is "Off", the audio is always output regardless of the video selection.
USB In		
Bluetooth In		
Audio Player		
PinP&Key 1–4 Follow	OFF, ON	When PinP&KEY 1–4 is "ON", this sets whether the audio is linked to the source video.
DSK 1, 2 Follow	OFF, ON	When DSK 1, 2 is "ON", this sets whether the audio is linked to the source video.

(*21) Depending on the "Video Player/SRT In" → "Type" setting, either V.Player or SRT in is displayed.

11: Audio Auto Mixing

Menu item	Value (bold text: default value)	Explanation
Jump To Setup	Enter	Jumps to the setup screen.
Audio Auto Mixing	OFF , ON	Turns the auto mixing function on/off. Auto mixing is a function that automatically controls the volume adjustments.
Audio In 1–6	Disable, Enable	Specifies whether Auto Mixing is applied (Enable) or not applied (Disable).
Weight	0– 100%	Specifies the weight level (the priority of volume distribution). * Setting the weight level to "0" results in no audio output.
Audio In 7/8–9/10	Disable, Enable	Specifies whether Auto Mixing is applied (Enable) or not applied (Disable).
Weight	0– 100%	Specifies the weight level (the priority of volume distribution). * Setting the weight level to "0" results in no audio output.
USB In	Disable , Enable	Specifies whether Auto Mixing is applied (Enable) or not applied (Disable).
Weight	0– 100%	Specifies the weight level (the priority of volume distribution). * Setting the weight level to "0" results in no audio output.
Bluetooth In	Disable , Enable	Specifies whether Auto Mixing is applied (Enable) or not applied (Disable).
Weight	0– 100%	Specifies the weight level (the priority of volume distribution). * Setting the weight level to "0" results in no audio output.
Audio Player	Disable , Enable	Specifies whether Auto Mixing is applied (Enable) or not applied (Disable).
Weight	0– 100%	Specifies the weight level (the priority of volume distribution). * Setting the weight level to "0" results in no audio output.
HDMI In 1–6	Disable , Enable	Specifies whether Auto Mixing is applied (Enable) or not applied (Disable).
Weight	0– 100%	Specifies the weight level (the priority of volume distribution). * Setting the weight level to "0" results in no audio output.
SDI In 1–6	Disable , Enable	Specifies whether Auto Mixing is applied (Enable) or not applied (Disable).
Weight	0– 100%	Specifies the weight level (the priority of volume distribution). * Setting the weight level to "0" results in no audio output.
Video Player/SRT In	Disable , Enable	Specifies whether Auto Mixing is applied (Enable) or not applied (Disable).
Weight	0– 100%	Specifies the weight level (the priority of volume distribution). * Setting the weight level to "0" results in no audio output.

12: Audio Player

Menu item	Value (bold text: default value)	Explanation
Jump To Setup	Enter	Jumps to the setup screen.
Audio Player Bank	Bank A , Bank B	Selects the audio player bank.
Audio Player 1–8	Specifies the audio player.	
Import	Enter	Imports the audio.
Name	Enter	Sets the name for an audio clip.
Duration	Display only	Shows the length of an audio clip.
Offset Time	0.0 – (length of audio clip)	Sets the playback start position of the audio clip.
Level	-INF– 0.0 –10.0dB	Sets the volume of the audio clip.
Fade In Time	0.0 –10.0sec	Sets the fade-in time.
Fade Out Time	0.0 –10.0sec	Sets the fade-out time.
Repeat	OFF, ON	When this is set to “ON”, the audio clip plays back in a loop.
Pad Mode	Latch	Toggles between playback and stop each time you press the pad. The audio plays back from the beginning.
	Pause	Toggles between playback and stop each time you press the pad. The audio plays back from where it last stopped.
	Replay	Plays back from the beginning when you press the pad.
	Momentary	Plays back audio while the pad is pressed.
Pad Color	White , Red, Green, Blue, Yellow, Magenta, Cyan, Dark Orange, Turquoise Green, Purple	Specifies the color of the corresponding pad when it lights up.
Playing Mode	BGM	Stops the BGM audio clip that’s currently playing, and plays back the new BGM audio clip (only one BGM audio clip can play back at a time).
	SE	Plays back without stopping the other audio clips.
	Solo	Stops all audio clips, and plays back only the soloed audio clip.

13: Stream/Record

Menu item	Value (bold text: default value)	Explanation	
Jump To Setup	Enter	Jumps to the setup screen.	
Type	Specifies how video signals are transmitted.		
	RTMP	Streams via RTMP.	
	SRT Out	Outputs SRT video.	
Start/Stop	When Type = RTMP Stop, On Air	Starts (On Air) or stops (Stop) streaming/recording.	
	When Type = SRT Out Stop, Streaming	Starts (On Air) or stops (Stop) SRT transmission.	
	When Type = RTMP		
Service 1, 2 Setup	Sets which platform is used for livestreaming.		
	Off	Livestreaming is not used.	
	Custom	Custom settings are used for streaming.	
	YouTube Live	Uses YouTube Live for streaming.	
	Facebook Live	Uses Facebook Live for streaming.	
	Twitch	Uses Twitch for streaming.	
	Menu item	Value (bold text: default value)	Explanation
	URL	—	Specifies the URL of the streaming server.
	Stream Key	—	Specifies the stream key.
	Use Web Application	Enter	Uses a Web app to set the streaming server URL and stream key.
When Type = SRT Out			
SRT Out Setup	This configures the SRT output.		
	Menu item	Value (bold text: default value)	Explanation
	Mode	Sets the operation mode for SRT connection.	
		Caller	In this mode, SRT connections are made from this unit by specifying the IP address and port number of the SRT receiving device (listener).
		Listener	This mode lets you listen for connections from SRT receiving devices (caller) by changing the settings of those devices to match the settings of this unit.
	When Mode = Caller		
	Remote IP Address	0.0.0.0	Sets the IP address of the SRT receiving device (listener).
	Remote Port	0– 2000 –65535	Sets the port number of the SRT receiving device (listener).
	Latency	80 –8000msec	Sets the length (delay time) of the SRT retransmission buffer. Out of the latencies set for the receiving and transmitting devices, the one with the larger value takes precedence.
	Stream ID	—	Sets the stream ID to the same ID as that of the SRT receiving device (listener).
	Encryption	None , AES-128, AES-192, AES-256	Sets the encryption method for encrypting video. * The transmitting and receiving device must both use the same the encryption method.
	Passphrase	—	Sets the passphrase when Encryption is set to anything other than "None". * The transmitting and receiving device must both use the same the passphrase.
	Use Web Application	Enter	You can use the web app to configure the above settings for SRT.
	When Mode = Listener		
	Local Port	0– 5000 –65535	Sets the port number used for listening for SRT connections.
	Latency	80 –8000msec	Sets the length (delay time) of the SRT retransmission buffer. Out of the latencies set for the receiving and transmitting devices, the one with the larger value takes precedence.
	Encryption	None , AES-128, AES-192, AES-256	Sets the encryption method for encrypting video. * The transmitting and receiving device must both use the same the encryption method.
	Passphrase	—	Sets the passphrase when Encryption is set to anything other than "None". * The transmitting and receiving device must both use the same the passphrase.
	Use Web Application	Enter	You can use the web app to configure the above settings for SRT.

Menu item	Value (bold text: default value)	Explanation
Target Bitrate	Specifies the target bitrate of encoding.	
Video	1,000–5,000, 6,000 , 7,000–20,000kbps	Specifies the target bitrate of video encoding.
Audio	32, 48, 64, 96, 128 , 160, 192, 224, 256kbps	Specifies the target bitrate of audio encoding.
Video Rec	Off , ON	Sets whether to record an MP4 file (ON) or not (OFF).
Audio Rec	Off , ON	Sets whether to record a WAV file (ON) or not (OFF).
Encode Profile	High , Main, Baseline	Specifies the profile of video encoding.
Encode Mode	This sets the optimal encoding method for the video.	
	Resolution	Suitable for presentations and other video contents that don't have a lot of motion.
	Motion	Suitable for sports programs, gaming videos and the like that have a lot of motion.
Safety Delay	Off , 5–60sec	Sets the streaming delay time that's used by the safety delay function.
Import Still Image	Exec	Loads the still image used for safety delay.
File Name	Display only	Shows the filename used for the safety delay's still image.

14: Scene Memory

Menu item	Value (bold text: default value)	Explanation
Jump To Setup	Enter	Jumps to the setup screen.
Start Up	Specifies the settings loaded at startup.	
	Last Memory	Restores the state that was in effect immediately before the power was turned off (Last Memory feature). The current settings (Last Memory values) are saved every 4 seconds, and when you exit a menu.
	1: MEMORY 1– 32: MEMORY 32 (*22)	Recall the settings at the selected scene memory.
Priority	Memory , Panel	Sets whether to give the scene memory or the panel state priority.
Memory Protect	OFF , ON	When this is "ON", prohibits settings from being saved or initialized. This protects the scene memories. * Protected scene memories are erased if you perform a factory reset.
Load From Storage	Enter	Shows a list of scene memory setting files (.VR120SCENE) on the storage media. You can select a scene memory setting file to recall a scene memory (1–32) on this unit.
Save To Storage	Enter	Shows a list of scene memory setting files (.VR120SCENE) on the storage media. You can select a scene memory setting file to save a scene memory (1–32) to the storage media.
Button Assign	Enter	This shows the Button Assign menu.
VIDEO SWITCHER Button 1–8	1: MEMORY 1– 32: MEMORY 32 (*22) The default values are as follows. 1: MEMORY 1 2: MEMORY 2 3: MEMORY 3 4: MEMORY 4 5: MEMORY 5 6: MEMORY 6 7: MEMORY 7 8: MEMORY 8	Selects the scene memories that are assigned to the VIDEO SWITCHER buttons.
Fade Time	0.0 –4.0sec	Sets how long the transition to the next video takes when recalling a scene memory. * The time you set is used for the parameters below.
Mix/Wipe	OFF, ON	When this is "ON", the transition effect is applied when the scene memory is recalled.
PinP & Key 1–4	OFF, ON	When this is "ON", the inset screen fades in when you recall a scene memory that includes a PinP composite.
DSK 1, 2	OFF, ON	When this is "ON", the superimposed caption and video fades in when you recall a scene memory that includes a DSK composite.
Load Parameters	Specifies whether to recall the following items when recalling a scene memory. Items that are turned off are excluded from the preset memories that are recalled.	
Video Assign	OFF, ON	Video Assign menu
Video Input	OFF, ON	Video Input menu
Video Output	OFF, ON	Video Output menu
Transition	Transition settings	
Transition Type	OFF, ON	Transition menu
Mix	OFF, ON	Mix menu
Wipe	OFF, ON	Wipe menu
Split 1	OFF, ON	Split 1 menu
Split 2	OFF, ON	Split 2 menu
PinP & Key	PinP & settings	
PinP & Key 1	OFF, ON	PinP & Key 1 menu
PinP & Key 2	OFF, ON	PinP & Key 2 menu
PinP & Key 3	OFF, ON	PinP & Key 3 menu
PinP & Key 4	OFF, ON	PinP & Key 4 menu
DSK	DSK settings	
DSK 1	OFF, ON	DSK 1 menu
DSK 2	OFF, ON	DSK 2 menu
Video Switcher Button	OFF, ON	VIDEO SWITCHER button state
AUX 1–3 Source	OFF, ON	AUX Source setting
Audio Fader/Knob Assign	OFF , ON	Audio Fader Assign menu
Audio Input	OFF , ON	Audio Input menu
Audio Output	OFF , ON	Audio Output menu
Audio Follow	OFF , ON	Audio Follow menu
Audio Auto Mixing	OFF , ON	Audio Auto Mixing menu

(*22) If you edited a scene memory's name using "Name Edit" from the setup screen, the edited name is shown.

15: Macro

Menu item	Value (bold text: default value)	Explanation
Jump To Setup	Enter	Jumps to the setup screen.
Load From Storage	Enter	Shows a list of the macro setting files (.RMC) that are on the storage. You can select a macro setting file and load the macro (1–100) into the unit.
Save To Storage	Enter	Shows a list of the macro setting files (.RMC) that are on the storage. You can select the macro settings file used to save the macro (1–100) to the storage.
Button Assign	Enter	This shows the Button Assign menu.
VIDEO SWITCHER Button 1–8	1: MACRO 1– 100: MACRO 100 (*23) The default values are as follows. 1: MACRO 1 2: MACRO 2 3: MACRO 3 4: MACRO 4 5: MACRO 5 6: MACRO 6 7: MACRO 7 8: MACRO 8	Selects the scene macro that are assigned to the VIDEO SWITCHER buttons.
Initialize	Enter	Initializes the macro.

(*23) If you edited a macro's name using "Name Edit" from the setup screen, the edited name is shown.

16: Sequencer

Menu item	Value (bold text: default value)	Explanation
Jump To Setup	Enter	Jumps to the setup screen.
Sequencer	OFF , ON	Turns the sequencer function on/off.
Repeat Execute	OFF , ON	When this is "ON", the recorded operation is repeatedly executed.
Auto Sequence	OFF , ON	When this is "ON", the recorded operation is automatically executed.
Load From Storage	Enter	Shows a list of the sequence files (.RSQ) that are on the storage. You can select a sequence file to load the sequencer settings into this unit. The current sequencer settings are overwritten.
Save To Storage	Enter	Shows a list of the sequence files (.RSQ) that are on the USB flash drive. You can select a sequence file to save the current sequencer settings to storage.
Initialize	Exec	Initializes the sequencer.

17: Still Image

Menu item	Value (bold text: default value)	Explanation						
Load From Storage	This loads a still image from the storage media.							
Still Image	Still 1–16	Specifies where to save still images imported from a storage to this unit's internal memory. * A "★" symbol is displayed for internal memory where a still image is already saved.						
Load	Enter	Shows a list of still image files on the storage media. Select still images in the list to load them from the storage media. Formats supported for loading						
		<table border="1"> <tr> <td>Format</td> <td>Bitmap file (.bmp), 24-bit color, uncompressed PNG file (.png), 24-bit color * Alpha channel supported JPEG file (.jpg), 24-bit color</td> </tr> <tr> <td>Resolution</td> <td>In conformity with system format</td> </tr> <tr> <td>File name</td> <td>No more than 64 single-byte alphanumeric characters * The extension ".bmp", ".png", ".jpg", or ".jpeg" must be added.</td> </tr> </table>	Format	Bitmap file (.bmp), 24-bit color, uncompressed PNG file (.png), 24-bit color * Alpha channel supported JPEG file (.jpg), 24-bit color	Resolution	In conformity with system format	File name	No more than 64 single-byte alphanumeric characters * The extension ".bmp", ".png", ".jpg", or ".jpeg" must be added.
		Format	Bitmap file (.bmp), 24-bit color, uncompressed PNG file (.png), 24-bit color * Alpha channel supported JPEG file (.jpg), 24-bit color					
		Resolution	In conformity with system format					
File name	No more than 64 single-byte alphanumeric characters * The extension ".bmp", ".png", ".jpg", or ".jpeg" must be added.							
Save To Storage	This exports a still image to storage media.							
Still Image	Still 1–16	Selects the still images to export to the USB flash drive. Press the [VALUE] knob to display a list of still images stored on the storage media (in the "Still" subdirectory). * A "★" symbol is displayed for internal memory where a still image is already saved. * The file formats of the still images that can be saved are the same as in "Formats supported for loading", above. * You can't export still images that were created while "HDCP" in the System menu was "ON". * When "HDCP" in the System menu is "ON", the text "(HDCP)" is shown for the captured still image.						
Save	Enter	Shows a list of still image files on the storage media. Select still images in the list to export them to the storage media.						
Save To Internal Storage	Enable , Disable	You can set the method of saving still images to "temporarily save". When you turn off the power while the status is "Disable", the captured still image is deleted.						
Delete Still Image	Deletes the still image.							
Still Image	All, Still 1–16	Selects the still images to delete. * A "★" symbol is displayed for internal memory where a still image is already saved.						
Delete	Exec	Deletes the selected still image(s).						

18: Video Player/SRT In

Menu item	Value (bold text: default value)	Explanation	
Jump To Setup	Enter	Jumps to the setup screen.	
Type	This selects whether to use the video player or the SRT input as the video source.		
	Video Player	Loads and plays videos that are saved in storage.	
	SRT In	Inputs SRT video.	
When Type = Video Player			
Import	Enter	Loads a video from the storage media.	
Name	—	Shows the filename of the video that was loaded.	
Duration	Display only	Shows the length of the video that was loaded.	
Skip Forward Time	0.0 –5.0sec	Sets how much the video fast-forwards each time.	
Skip Backward Time	0.0 –5.0sec	Sets how much the video rewinds each time.	
Level	-INF– 0.0 –10.0dB	Adjusts the output volume.	
Repeat	OFF , ON	When this is “ON”, the video plays back repeatedly.	
When Type = SRT In			
Start/Stop	Stopped, Started	Starts/stops SRT input.	
SRT In Setup	Configures the SRT input settings.		
	Menu item	Value (bold text: default value)	Explanation
	Mode	Sets the operation mode for SRT connection.	
		Caller	In this mode, SRT connections are made from this unit by specifying the IP address and port number of the SRT transmitting device (listener).
		Listener	This mode lets you listen for connections from SRT transmitting devices (caller) by changing the settings of those devices to match the settings of this unit.
	When Mode = Caller		
	Capacity	Sets the maximum bit rate at which a video signal can be received.	
		Standard	Video data can be received up to a bit rate of 10 Mbps.
		High	Video data can be received up to a bit rate of 20 Mbps. * This setting cannot be used at the same time as streaming/recording or SRT output.
	Remote IP Address	0.0.0.0	Sets the IP address of the SRT transmitting device (listener).
	Remote Port	0– 5000 –65535	Sets the port number of the SRT transmitting device (listener).
	Latency	80 –8000msec	Sets the length (delay time) of the SRT retransmission buffer. Out of the latencies set for the receiving and transmitting devices, the one with the larger value takes precedence.
	Stream ID	—	Sets the stream ID to the same ID as that of the SRT transmitting device (listener).
	Passphrase	—	Sets the passphrase to the same passphrase as that of the SRT transmitting device (listener).
	Use Web Application	Enter	You can use the web app to configure the above settings for SRT.
	When Mode = Listener		
	Capacity	Sets the maximum bit rate at which a video signal can be received.	
		Standard	Video data can be received up to a bit rate of 10 Mbps.
		High	Video data can be received up to a bit rate of 20 Mbps. * This setting cannot be used at the same time as streaming/recording or SRT output.
Local Port	0– 2000 –65535	Sets the port number used for listening for SRT connections.	
Latency	80 –8000msec	Sets the length (delay time) of the SRT retransmission buffer. Out of the latencies set for the receiving and transmitting devices, the one with the larger value takes precedence.	
Passphrase	—	Sets the passphrase to the same passphrase as that of the SRT transmitting device (caller).	
Use Web Application	Enter	You can use the web app to configure the above settings for SRT.	

19: Roland Fill+Key

Menu item	Value (bold text: default value)	Explanation
Mode	Off , DSK 1, DSK 2	Sets the DSK layer (DSK 1 or DSK 2) to use when in Roland Fill+Key mode. * If you select "DSK 1" or "DSK 2", the DSK Mode setting in the DSK menu is automatically set to "Roland Fill+Key", and the unit switches to Roland Fill+Key mode.

20: Freeze

Menu item	Value (bold text: default value)	Explanation
Jump To Setup	Enter	Jumps to the setup screen.
Freeze	OFF , ON	Turns the freeze function on/off. When this is "ON", the input video is temporarily frozen.
Type	Specifies the operation mode for freezes.	
	All	Freezes all video that is being input.
	Select	Freezes only the specified input video.
HDMI 1-6 (*24)	Disable, Enable	For each input, specifies whether the freeze function is enabled (Enable) or disabled (Disable).
SDI 1-6 (*24)	Disable, Enable	

(*24) This can be set if "Type" is "Select".

21: Auto Switching

Menu item	Value (bold text: default value)	Explanation
Jump To Setup	Enter	Jumps to the setup screen.
Auto Switching	OFF , ON	Turns the auto switching function on/off. When this is "ON", the video or scene memory are switched automatically.
Type	Specifies the operation mode for auto switching.	
	Input Scan	Automatically switches to the video of Input 1-8 when the specified interval.
	Scene Memory Scan	Automatically recalls scene memories 1-32 at the specified interval. The video and audio are switched according to the settings that are saved in each scene memory.
	Beat Sync	The video switches in time with the beat of the song.
	Video Follows Audio	The video switches along with the audio from the mic.
	PinP&Key 1-4 Scan	Automatically switches to the video of PinP&KEY when the specified interval.
	DSK 1, 2 Scan	Automatically switches to the video of DSK when the specified interval.
When Type = Input Scan		
Scan Sequence	Specifies the order in which video signals are shown. * If there is no video input, this is skipped.	
	Normal	Switches in the order of Input 1 → 8.
	Reverse	Switches in the order of Input 8 → 1.
	Random	Switches randomly.
Scan Transition Time	0.0- 1.0 -4.0sec	Specifies the video transition time.
Scan Target	Sets the video to which auto switching is applied.	
	Video Input	Final output video and preview video
	PinP & Key 1-4	PinP and key layer (inset screen) video
	DSK 1-2	DSK and key layer video
Input 1-8 Time	Off, 1- 5 -120sec	Specifies the time that the video is shown. Turn this "OFF" to skip.
When Type = Scene Memory Scan		
Scan Sequence	Specifies the order in which scene memories are switched. * Scene memories in which no settings have been saved are skipped.	
	Normal	Switches in the order of scene memory 1 → 32.
	Reverse	Switches in the order of scene memory 32 → 1.
	Random	Switches randomly.
Memory 1-32 Time	Off, 1- 5 -120sec	Specifies the time it takes to switch to the next scene memory. Turn this "OFF" to skip.

Menu item	Value (bold text: default value)	Explanation	
When Type = Beat Sync			
Sync Source	Audio In 1–Audio In 9/10, USB In, Bluetooth In, Audio Player, HDMI 1–6, SDI 1–6, V.Player/SRT In (*25)	Sets the input audio that's synchronized with the video.	
Scan Sequence	Specifies the order in which video signals are shown. * If there is no video input, this is skipped.		
	Normal	Switches in the order of Input 1 → 8.	
	Reverse	Switches in the order of Input 8 → 1.	
	Random	Switches randomly.	
Scan Transition Time	0.0– 1.0 –4.0sec	Specifies the video transition time.	
Scan Cycle	1– 4 –10	Sets the beat number on which the video switches to the next one.	
Scan Target	Video Input , PinP & Key 1–4, DSK 1–2	Sets the video to which auto switching is applied.	
When Type = Video Follows Audio			
Audio In 1–9/10 Target, USB In Target, Bluetooth In Target, Audio Player Target, HDMI 1–6 Target, SDI 1–6 Target, V.Player/SRT In Target (*25)	Off, Input 1–8, Memory 1–32, Macro 1–100	Sets what happens when audio is detected.	
		Input 1–8	Switches the output video.
		Memory 1–32	Recalls a scene memory.
		Macro 1–100	Executes a macro (a series of recorded operations).
Threshold	-50– 16 –0dB	Specifies the reference level at which the Video Follows Audio function operates. When audio that exceeds this threshold is detected, the video is switched.	
Audio Mix Target	Off, Input 1–8, Memory 1–32, Macro 1–100	Specifies the video that is output when audio is detected in multiple mics. If this is "Off", video is switched in the order in which audio is detected.	
Audio Silent Target	Off, Input 1–8	Specifies the video that is output when there is no audio input from any mic. If this is "Off", the last selected video continues to be output.	
Audio Redetection Time	0.0– 4.0 –30.0sec	Specifies the time after the video has switched until audio detection resumes.	
Scan Transition Time	0.0– 1.0 –4.0sec	Specifies the video transition time.	
When Type = PinP&Key 1–4 Scan, DSK 1, 2 Scan			
Scan Sequence	Specifies the order in which video signals are shown.		
	Normal	Switches in the order of HDMI 1 → 6, SDI 1 → 6, Still 1 → 16.	
	Reverse	Switches in the order of Still 16 → 1, SDI 6 → 1, HDMI 6 → 1.	
	Random	Switches randomly.	
HDMI 1–6 Time	Off, 1– 5 –120sec	Specifies the time that the video is shown. Turn this "Off" to skip.	
SDI 1–6 Time	Off, 1– 5 –120sec	Specifies the time that the video is shown. Turn this "Off" to skip.	
Still 1–16 Time	Off, 1– 5 –120sec	Specifies the time that the still image is shown. Turn this "Off" to skip.	
V.Player/SRT In Time (*25)	Off, 1– 5 –120sec	Specifies the time that the video is shown. Turn this "Off" to skip.	

(*25) Depending on the "Video Player/SRT In" → "Type" setting, either V.Player or SRT in is displayed.

22: Ctl/Exp

Menu item	Value (bold text: default value)	Explanation	
Ctl/Exp 1, 2	These settings for the footswitch or expression pedal connected to the CTL/EXP 1, 2 jacks.		
Ctl/Exp Type	Settings for the devices (footswitch or expression pedal) connected to the CTL/EXP 1, 2 jacks.		
	Off	Disables the CTL/EXP jack.	
	Ctl A & Ctl B	Choose this if a footswitch is connected.	
	Exp	Choose this if an expression pedal is connected.	
When Ctl/Exp Type = Ctl A & Ctl B			
Assign	Specifies the functions that are assigned to Ctl A and Ctl B of the footswitch.		
Ctl A Ctl B	Category	Value	Explanation
	N/A	---	No function is assigned.
	PGM Channel Select	HDMI 1-6, SDI 1-6, Still 1-16, V.Player/SRT In (*26), Input 1-8	Switches the video sent to the PGM bus.
	PST Channel Select	HDMI 1-6, SDI 1-6, Still 1-16, V.Player/SRT In (*26), Input 1-8	Switches the video sent to the PST bus.
	AUX 1-3 Channel Select	HDMI 1-6, SDI 1-6, Still 1-16, V.Player/SRT In (*26), Input 1-8	Switches the video sent to the AUX bus.
	Input 1-8 Assign	HDMI 1-6, SDI 1-6, Still 1-16, V.Player/SRT In (*26), Stream/Record Status 1-2, Date&Time(Analog/Digital) (*27), N/A	Changes the video assigned to Input 1-8.
	Still Output	Still 1-16	Pauses the normal output, and previews or final outputs a cut of the still image. Press the footswitch again to return to normal output.
	Video Player Output	---	Pauses the normal output, and cuts to the preview/final output of the video player image.
	PinP&Key 1-4 Source	HDMI 1-6, SDI 1-6, Still 1-16, V.Player/SRT In (*26), Input 1-8	Switches the video source of the inset screen.
	DSK 1, 2 Source	HDMI 1-6, SDI 1-6, Still 1-16, V.Player/SRT In (*26), Input 1-8	Switches the DSK video source.
	Button Control	CUT Button, AUTO Button MIX Button, WIPE Button SPLIT 1 Button, SPLIT 2 Button PinP&KEY 1-4 PVW Button PinP&KEY 1-4 PGM Button DSK 1, 2 PVW Button DSK 1, 2 PGM Button, USER 1-4 Button AUDIO EFFECT 1-4 Button AUDIO PLAYER 1-8 Pad	This works the same as when you press the button selected in "VALUE".
	Audio Input Mute	Audio In 1-9/10, USB In, Bluetooth In, Audio Player, HDMI 1-6, SDI 1-6, V.Player/SRT In (*26)	Turns the mute function on/off for the input audio.
	Audio Output Mute	Main Bus, AUX 1 Bus, AUX 2 Bus, AUX 3 Bus, USB Out, Stream/Record, Monitor Bus	Turns the mute function on/off for the output audio.
	Audio Input Solo	Audio In 1-9/10, USB In, Bluetooth In, Audio Player, HDMI 1-6, SDI 1-6, V.Player/SRT In (*26)	Turns the solo function on/off for the input audio.
	Audio Output Solo	Main Bus, AUX 1 Bus, AUX 2 Bus, AUX 3 Bus	Turns the solo function on/off for the output audio.
	Voice Changer	Audio In 1, 2	Turns the voice changer on/off.
	Auto Mixing	---	Turns the auto mixing function on/off.
	Reverb (Momentary)	---	Reverb turns on only while you press the footswitch.
	Reverb (Alternate)	---	Turns reverb on/off.
	Output Fade	---	The final output video fades in/out.
	Load Memory	Memory 1-32	Recalls a scene memory.
	Input Scan	Normal	Each time you press the footswitch, the final output switches from Input 1-8 in sequential order.
		Reverse	Each time you press the footswitch, the final output switches from Input 1-8 in reverse order.

(*26) Depending on the "Video Player/SRT In" → "Type" setting, either V.Player or SRT in is displayed.

(*27) The analog/digital display changes in the "System → Date&Time → Clock Display Type" setting.

Menu item	Value (bold text: default value)	Explanation	
Ctl A Ctl B	Category	Value	Explanation
	Scene Memory Scan	Normal	Each time you press the footswitch, scene memories 1–32 are recalled in sequential order.
		Reverse	Each time you press the footswitch, scene memories are recalled in reverse order from 32 through 1.
	PinP&Key 1–4 Scan	Normal	The PinP&Key 1–4 inset screen videos switch between HDMI 1→6, SDI 1→6 and Still 1→16 in order each time you press the footswitch.
		Reverse	The PinP&Key 1–4 inset screen videos switch between Still 16→1, SDI 6→1 and HDMI 6→1 in order each time you press the footswitch.
	DSK 1–2 Scan	Normal	The DSK 1 and 2 caption videos switch between HDMI 1→6, SDI 1→6 and Still 1→16 in order each time you press the footswitch.
		Reverse	The DSK 1 and 2 caption videos switch between Still 16→1, SDI 6→1 and HDMI 6→1 in order each time you press the footswitch.
	Macro Execute	Macro 1–100	Executes a macro (a series of recorded operations).
	Sequencer	Mode On/Off, Next, Previous, Auto Sequence	When the sequencer function is on, this works the same as when you press the button selected in "VALUE".
	GPO (One Shot)	GPO 1–16	Outputs a control signal for 0.5 seconds.
	GPO (Alternate)	GPO 1–16	The control signal output is switched on/off with each press of the footswitch.
	Camera Control	Mode	Turns the camera control on/off.
		Pan Left	Pans the camera to the left.
		Pan Right	Pans the camera to the right.
		Tilt Down	Pans the camera down.
		Tilt Up	Pans the camera up.
		Zoom Wide (Slow)	Zooms out at low speed.
Zoom Wide (Fast)		Zooms out at high speed.	
Zoom Tele (Slow)		Zooms in at low speed.	
Zoom Tele (Fast)		Zooms in at high speed.	
Focus Near		Moves the focus closer.	
Focus Far		Moves the focus farther away.	
Auto Focus		Turns the camera auto focus on/off.	
Auto Exposure	Turns the camera auto-exposure on/off.		
Preset 1–8 Recall	Recalls presets 1–8 that are registered in the camera.		
When Ctl/Exp Type = Exp			
Assign	Specifies the function that is assigned to the expression pedal.		
Exp	Category	Value	Explanation
	N/A	---	No function is assigned.
	Video Fader	Fade	Operates the video fader.
		Cut	Cuts between the final output video and the preview video.
	Still Output	Still 1–16	Pauses the normal output, and previews or final outputs a cut of the still image.
	Video Player Output	---	Pauses the normal output, and cuts to the preview/final output of the video player image.
	Audio Input Level	Audio In 1–9/10, USB In, Bluetooth In, Audio Player, HDMI 1–6, SDI 1–6, V.Player/SRT In (*28)	Adjusts the input volume.
	Audio Output Level	Main Bus, AUX 1 Bus, AUX 2 Bus, AUX 3 Bus, USB Out, Stream/Record, Monitor Bus	Adjusts the output volume.
	Voice Changer	Audio In 1 Pitch, Audio In 1 Formant, Audio In 1 Mix, Audio In 2 Pitch, Audio In 2 Formant, Audio In 2 Mix	Adjusts the balance between the unprocessed voice (0) and the voice processed by the effect (100).
Reverb Level	---	Adjusts the amount of sound that is returned from the reverb (return level).	
Exp Calibration	Enter	Displays the Exp Calibrate screen. Following the direction on the screen, calibrate (adjust) the expression pedal. The first time you use the expression pedal, be sure to execute calibration so that the pedal will operate optimally. In some cases, the expression pedal might no longer be operating optimally because of the passage of time or the conditions of use. In such cases you should also execute expression pedal calibration.	

(*28) Depending on the "Video Player/SRT In" → "Type" setting, either V.Player or SRT in is displayed.

23: RS-232/Tally/GPO/GPI/Keypad

Menu item	Value (bold text: default value)	Explanation	
RS-232	These are the settings for transmitting/receiving RS-232 commands.		
RS-232	OFF, ON	When this is "ON", RS-232 commands can be transmitted and received.	
Baudrate	9600, 38400, 115200	Specifies the communication speed (bps) of the RS-232 connector.	
Tally/GPO	These are settings for tally signals or control signals that are output from the TALLY/GPIO connector.		
Template	HDMI Tally , SDI Tally, GPO, HDMI Tally/GPO, SDI Tally/GPO	Selects a TALLY/GPO 1–16 settings template. Press the [VALUE] knob to apply the template settings to "TALLY/GPO 1–16".	
TALLY/GPO 1–16	Assigns the tally signal to TALLY/GPIO connector pins 1–16.		
	PGM HDMI 1–6 PGM SDI 1–6	A tally signal is output when the video sent from the connector in question is the final output.	
	PGM Still 1–16	A tally signal is output when the still image in question is the final output.	
	PGM Video Player/SRT In	A tally signal is output when the video sent from the video player/SRT input in question is the final output.	
	PGM Input 1–8	A tally signal is output when the final output video is selected using the VIDEO SWITCHER button in question (the button lights up red).	
	PST HDMI 1–6 PST SDI 1–6	A tally signal is output when the video sent from the connector in question is the preview output.	
	PST Still 1–16	A tally signal is output when the still image in question is the preview output.	
	PST Video Player/SRT In	A tally signal is output when the video sent from the video player/SRT input in question is the preview output.	
	PST Input 1–8	A tally signal is output when the preview output video is selected using the VIDEO SWITCHER button in question (the button lights up green).	
	Assigns the GPO to TALLY/GPIO connector pins 1–16.		
	GPO 1–16	A control signal is output when you press a USER button or the footswitch, or assign a GPO output function to a GPI pin.	
Tally Settings			
AUX 1–3 (PGM)	Disable, Enable	When set to "Enable", the output status of the relevant video bus is reflected in the tally information.	
PinP&Key 1–4 (PGM/PST)			
DSK 1, 2 (PGM/PST)			
GPI, Numeric Keypad	These settings assign the functions to the GPI or a numeric keypad.		
GPI 1–8 Keypad 0–9, +, -, *, /, ., Enter	When an external control signal is input or you press a key, the assigned functions are executed.		
	Category	Value	Explanation
	N/A	--	No function is assigned.
	PGM Channel Select	HDMI 1–6, SDI 1–6, Still 1–16, V.Player/SRT In (*29), Input 1–8	Switches the video sent to the PGM bus.
	PST Channel Select	HDMI 1–6, SDI 1–6, Still 1–16, V.Player/SRT In (*29), Input 1–8	Switches the video sent to the PST bus.
	AUX 1–3 Channel Select	HDMI 1–6, SDI 1–6, Still 1–16, V.Player/SRT In (*29), Input 1–8	Switches the video sent to the AUX bus.
	Input 1–8 Assign	HDMI 1–6, SDI 1–6, Still 1–16, V.Player/SRT In (*29), Stream/Record Status 1–2, Date&Time(Analog/Digital) (*30), N/A	Changes the video assigned to Input 1–8.
	Still Output	Still 1–16	Pauses the normal output, and previews or final outputs a cut of the still image. When a control signal is input again, the signal output returns to normal.
	Video Player Output	---	Pauses the normal output, and cuts to the preview/final output of the video player image.
	PinP&Key 1–4 Source	HDMI 1–6, SDI 1–6, Still 1–16, V.Player/SRT In (*29), Input 1–8	Switches the video source of the inset screen.
	DSK 1, 2 Source	HDMI 1–6, SDI 1–6, Still 1–16, V.Player, Input 1–8	Switches the DSK video source.
Button Control	CUT Button, AUTO Button MIX Button, WIPE Button SPLIT 1 Button, SPLIT 2 Button PinP&KEY 1–4 PVW Button PinP&KEY 1–4 PGM Button DSK 1, 2 PVW Button DSK 1, 2 PGM Button USER 1–4 Button AUDIO EFFECT 1–4 Button AUDIO PLAYER 1–8 Pad	This works the same as when you press the button selected in "VALUE".	

(*29) Depending on the "Video Player/SRT In" → "Type" setting, either V.Player or SRT in is displayed.

(*30) The analog/digital display changes in the "System → Date&Time → Clock Display Type" setting.

Menu item	Value (bold text: default value)	Explanation	
GPI 1-8 Keypad 0-9, +, -, *, /, ,, Enter	Category	Value	Explanation
	Audio Input Mute	Audio In 1-9/10, USB In, Bluetooth In, Audio Player, HDMI 1-6, SDI 1-6, V.Player/SRT In (*31)	Turns the mute function on/off for the input audio.
	Audio Output Mute	Main Bus, AUX 1 Bus, AUX 2 Bus, AUX 3 Bus, USB Out, Stream/Record, Monitor Bus	Turns the mute function on/off for the output audio.
	Audio Input Solo	Audio In 1-9/10, USB In, Bluetooth In, Audio Player, HDMI 1-6, SDI 1-6, V.Player/SRT In (*31)	Turns the solo function on/off for the input audio.
	Audio Output Solo	Main Bus, AUX 1 Bus, AUX 2 Bus, AUX 3 Bus	Turns the solo function on/off for the output audio.
	Voice Changer	Audio In 1, 2	Turns the voice changer on/off.
	Auto Mixing	---	Turns the auto mixing function on/off.
	Reverb (Momentary)	---	Reverb turns on only while a control signal is input.
	Reverb (Alternate)	---	Turns reverb on/off.
	Output Fade	---	The final output video fades in/out.
	Load Memory	Memory 1-32	Recalls a scene memory.
	Input Scan	Normal	Each time a control signal is input, the final output switches from Input 1-8 in sequential order.
		Reverse	Each time a control signal is input, the final output switches from Input 1-8 in reverse order.
	Scene Memory Scan	Normal	The scene memories 1 through 32 are recalled in order each time a control signal is input.
		Reverse	The scene memories are recalled in reverse order from 32 through 1 each time a control signal is input.
	PinP&Key 1-4 Scan	Normal	The PinP&Key 1-4 inset screen videos switch between HDMI 1-6, SDI 1-6 and STILL 1-16 in order each time you input a control signal.
		Reverse	The PinP&Key 1-4 inset screen videos switch between STILL 16-1, SDI 6-1 and HDMI 6-1 in order each time you input a control signal.
	DSK 1, 2 Scan	Normal	The DSK 1 and 2 caption videos switch between HDMI 1-6, SDI 1-6 and STILL 1-16 in order each time you input a control signal.
		Reverse	The DSK 1 and 2 caption videos switch between STILL 16-1, SDI 6-1 and HDMI 6-1 in order each time you input a control signal.
	Macro Execute	Macro 1-100	Executes a macro (a series of recorded operations).
	Sequencer	Mode On/Off, Next, Previous, Auto Sequence	When the sequencer function is on, this works the same as when you press the button selected in "VALUE".
	GPO (One Shot)	GPO 1-16	Outputs a control signal for 0.5 seconds.
	GPO (Alternate)	GPO 1-16	The control signal output is switched on/off each time a control signal is input.
	Camera Control	Mode	Turns the camera control on/off.
		Pan Left	Pans the camera to the left.
		Pan Right	Pans the camera to the right.
		Tilt Down	Pans the camera down.
		Tilt Up	Pans the camera up.
		Zoom Wide (Slow)	Zooms out at low speed.
		Zoom Wide (Fast)	Zooms out at high speed.
		Zoom Tele (Slow)	Zooms in at low speed.
		Zoom Tele (Fast)	Zooms in at high speed.
Focus Near		Moves the focus closer.	
Focus Far		Moves the focus farther away.	
Auto Focus		Turns the camera auto focus on/off.	
Auto Exposure		Turns the camera auto-exposure on/off.	
Preset 1-8 Recall	Recalls presets 1-8 that are registered in the camera.		

(*31) Depending on the "Video Player/SRT In" → "Type" setting, either V.Player or SRT in is displayed.

24: Network

Menu item	Value (bold text: default value)	Explanation		
Jump To Setup	Enter	Jumps to the setup screen.		
Priority	LAN , Tethering	Sets whether to prioritize the LAN connection or your smartphone tethering when streaming.		
LAN Setup	Enter	Accesses the LAN settings.		
Configure	Selects how settings are made for the IP address, subnet mask, and default gateway.			
	Manual	This is to be configured manually.		
	Using DHCP	The IP address and other information needed for connecting to the network is obtained automatically from the DHCP server of the LAN.		
IP Address (*32)	---,---,---,---	Specifies the IP address as appropriate for the network to which the unit is connected.		
Subnet Mask (*32)	---,---,---,---	Specifies the subnet mask as appropriate for the network to which the unit is connected.		
Default Gateway (*32)	---,---,---,---	Specifies the default gateway as appropriate for the network to which the unit is connected.		
DNS Server (*32)	---,---,---,---	Specifies the DNS server address as appropriate for the network to which the unit is connected.		
Start Tethering Stop Tethering	Exec	Starts/stops tethering with your smartphone.		
Network Information	Enter	Displays the Network Information screen.		
	Displays the following information.			
	Item	Explanation		
	Link Status	Connection status		
	IP Address	IP address		
	Subnet Mask	Subnet mask.		
	Default Gateway	Default gateway		
DNS Server	DNS server			
2D Code for Smart Tally	Enter	Displays the QR code for accessing the Smart Tally settings screen (Web). * Note that the QR code is not shown if the VR-120HD is disconnected from the network.		
User Name	user	Shows the user name required to connect to the network.		
Network Password	Enter	Displays the Network Password screen. Set the necessary password for network connection, using four characters.		
		Show password		
		<table border="1"> <tr> <td>Password not set</td> <td>_____</td> </tr> <tr> <td>Password set</td> <td>****</td> </tr> </table>	Password not set	_____
Password not set	_____			
Password set	****			
* Input the password that's set here when connecting a computer or other device on the same network to access the VR-120HD.				
MAC Address	--:--:--:--:--:--	Displays the MAC address.		

(*32) This can be set if "Configure" is "Manual".

25: Camera Control

Menu item	Value (bold text: default value)	Explanation
Jump To Setup	Enter	Jumps to the setup screen.
Camera ID	Camera 1–12	Selects the camera to be controlled.
Protocol	N/A , JVC, Panasonic, Canon PTZ, VISCA over IP, PTZOptics, Avonic	Specifies the camera's protocol.
IP Address	192.168.0.101	Input the camera's IP address.
Login Name	Enter	Displays the Login Name screen. Enter the log-in name needed to connect with the camera when "Protocol" is "JVC".
Password	Enter	Displays the Password screen. Enter the password needed to connect with the camera when "Protocol" is "JVC".
Camera Preset	Preset 1–8	Selects the preset used when recalling or registering the settings.
Recall	Exec	By pressing the [VALUE] knob you can recall a preset from the camera. By assigning a USER button to the camera control function, you can recall presets using the buttons (p. 99).
All Cameras Recall	OFF	Recall presets from the camera that is being controlled.
	ON	Simultaneously recall presets from all cameras (Camera 1–12).
Store	Exec	By pressing the [VALUE] knob you can register the camera settings to a preset. * Presets are saved in the camera itself.
Tally Channel	HDMI 1–6 , SDI 1–6, SRT In	Specifies the connector from which the camera video is input. When the camera video from the VR-120HD is the final output, the camera's tally light is lit.

26: SD Card/USB Memory

Menu item	Value (bold text: default value)	Explanation
SD Card	These are the SD card-related parameters.	
Access Type	A, B	Sets the method of accessing the SD card. If the VR-120HD does not recognize the SD card, change the Access Type setting. * The setting is applied at startup.
Eject	Exec	Safely ejects and allows you to remove the SD card.
Format	Exec	Formats the SD card.
Speed Test	Exec	Measures the data write speed to the SD card.
USB Memory	These are the USB flash drive-related parameters.	
Eject	Exec	Safely ejects and allows you to remove the USB flash drive.
Format	Exec	Formats the USB flash drive.
Speed Test	Exec	Measures the data write speed to the USB flash drive.
Restore All Settings	Enter	Shows a list of the setting files (.VR120) that are on the USB flash drive. You can select a setting file and restore the settings into the unit. The current settings are overwritten.
Backup All Settings	Enter	Shows a list of the setting files (.VR120) that are on the USB flash drive. You can select the settings file used to back up the current settings to the USB flash drive. * Some settings are not saved to the file, such as the "Test Pattern" and "Test Tone" settings in the System menu.

27: System

Menu item	Value (bold text: default value)	Explanation	
HDCP	Specifies whether HDCP is enabled (ON) or disabled (OFF).		
	OFF	Copy-protected (HDCP) video cannot be input.	
	ON	Copy-protected (HDCP) video can be input. HDCP is also added to the video that is output. * Video/audio from the SDI OUT connectors and the USB STREAM port are not outputted.	
Output Format	Specifies the output format.		
System Format	1080p , 720p	Specifies the system format.	
HDMI Out 1-3	1080p , 1080i, 720p	Sets the output format for the HDMI OUT 1-3 connectors.	
SDI Out 1-3	1080p , 1080i, 720p	Sets the output format for the SDI OUT 1-3 connectors.	
USB Out	1080p , 720p	Specifies the output format of the USB STREAM port.	
Stream/Record	1080p , 720p	Specifies the output format of the DIRECT STREAM port.	
Frame Rate	60, 59.94 , 50, 30, 29.97, 25, 24, 23.98Hz	Specifies the frame rate.	
USB Out	30, 60Hz	Specifies the frame rate of the USB STREAM port. * The value differs depending on the "Frame Rate" setting.	
	29.97, 59.94Hz		
	25, 50Hz		
Stream/Record	30, 60Hz	Specifies the frame rate of the DIRECT STREAM port. * The value differs depending on the "Frame Rate" setting.	
	29.97, 59.94Hz		
	25, 50Hz		
Reference	Specifies the reference clock of the VR-120HD.		
	Internal	The VR-120HD's internal clock is used as the reference clock	
	External	A synchronizing signal input via the REFERENCE IN connector is used as the reference clock. Black-burst (frame synchronization), bi-level, and tri-level synchronizing signals are supported.	
	SDI 1-6	A signal input via one of the SDI IN 1-6 connectors is used as the reference clock. The VSYNC (vertical synchronizing) signal output from the VR-120HD is synchronized to the VSYNC signal input via SDI.	
Clock Adjust	-1920- 0 -1920	This adjusts the phase horizontally. Adjust this when output is horizontally out of sync with the operation of other devices using the same clock.	
Line Adjust	-1200- 0 -1200	This adjusts the phase vertically. Adjust this when output is vertically out of sync with or field-shifted from the operation of other devices using the same clock.	
Lock Status	--	Indicate the lock status.	
Bluetooth Pairing	Menu item	Value	Explanation
	Bluetooth	OFF , ON	Turns the Bluetooth function on/off.
	Pairing	Exec	Begins pairing with a Bluetooth device.
	Status	Displays the Bluetooth connection status.	
		Off	Bluetooth off
		Pairing Mode	Now pairing
		Not Connected	Waiting for connection
	Connected	Connected	
Date&Time	Menu item	Value	Explanation
	Configure	Selects how the time is set.	
		Manual	The time is set manually.
		Using NTP	The time is set by retrieving the time from an NTP server.
	Time Zone	-	Sets the time zone.
	Date Format	Month/Day/Year Day/Month/Year Year/Month/Day	Sets the format used for displaying the date.
	Clock Display Type	Analog , Digital	Sets the type of time display used.
	NTP Server	-	Specifies the default NTP server.
Manual	Enter	The time is set manually.	
Language/言語/语言	English , 日本語, 简体中文	Changes the language that's used on the Menu screens and the Setup screens.	

Menu item	Value (bold text: default value)	Explanation
Panel Operation	Specifies the operation mode for video transitions.	
	Dissolve	This mode selects the video to output and immediately outputs it to the PGM bus.
	PGM/PST	In this mode, the PST video is displayed in the PVW bus, and you can check the video before outputting it to the PGM bus.
Effects Transition Sync	OFF , ON	Sets whether the PinP/DSK composites are switched on and off in tandem with the video transitions. When this is "ON", the PinP/DSK composition turn on/off in tandem with the video transitions. The composited result that is previewed is sent to final output when transitioning to a different video. * Enabled when Panel Operation is "PGM/PST".
Effects Spot	OFF, ON	Specifies whether the spot function for the [PVW] and [PGM] buttons is enabled (Enable) or disabled (Disable). With the spot function, long-pressing the [PVW] or [PGM] button for each layer shows only the layer that is targeted for the operation while the button is pressed.
Analog Fader/Knob Mode	Catch	When a fader or knob is operated, if the position of the fader or knob does not match the value of the parameter, the operation is ignored until the position matches the parameter's value. * The [SETUP] button or SIG/PEAK indicator blinks while the fader operations are being ignored. The closer the fader or knob position gets to the parameter's value, the faster the button blinks.
	Direct	The value of the parameter in question immediately changes to match the position of the fader or knob when you operate them.
Panel Lock	Enable (ON) or disable (OFF) the panel lock.	
	Menu item	Explanation
	All	The following settings are turned on/off together.
	Touch Panel	Touch panel operation
	VIDEO SWITCHER All	Buttons in VIDEO section
	VIDEO SWITCHER 1-8 Button	VIDEO SWITCHER [1]-[8] buttons
	CUT Button	[CUT] button
	AUTO Button	[AUTO] button
	MODE All	Buttons in MODE section
	SETUP Button	MODE [SETUP] button
	INPUT SELECT Button	[INPUT SELECT] button
	AUX Button	[AUX] button
	SCENE MEMORY Button	[SCENE MEMORY] button
	MACRO Button	[MACRO] button
	TRANSITION All	Buttons in TRANSITION section
	SETUP Button	TRANSITION [SETUP] button
	MIX Button	[MIX] button
	WIPE Button	[WIPE] button
	SPLIT 1 Button	[SPLIT 1] button
	SPLIT 2 Button	[SPLIT 2] button
	PinP&KEY 1-4 All	Buttons in PinP&KEY 1-4 section
	SETUP Button	PinP&KEY 1-4 [SETUP] button
	PVW Button	PinP&KEY 1-4 [PVW] button
	PGM Button	PinP&KEY 1-4 [PGM] button
	DSK 1-2 All	Buttons in DSK1-2 section
	SETUP Button	DSK1-2 [SETUP] button
	PVW Button	DSK1-2 [PVW] button
	PGM Button	DSK1-2 [PGM] button
	USER Button All	Buttons in USER section
	SETUP Button	USER [SETUP] button
	USER 1-4 Button	USER [1]-[4] button
	Menu item	Explanation
MONITOR Button All	Buttons in MONITOR section	
SETUP Button	MONITOR [SETUP] button	
MONITOR 1-4 Button	MONITOR [1]-[4] button	
CAPTURE IMAGE Button	[CAPTURE IMAGE] button	
AUDIO LEVEL Button	[AUDIO LEVEL] button	
OUTPUT FADE Button	[OUTPUT FADE] button	
AUDIO MIXER 1-9/10 All	Buttons and knobs in AUDIO INPUT section	
GAIN 1-9/10 Knob	GAIN [1]-[9/10] knob	
SETUP 1-9/10 Button	SETUP [1]-[9/10] buttons	
SOLO 1-9/10 Button	SOLO [1]-[9/10] buttons	
MUTE 1-9/10 Button	MUTE [1]-[9/10] buttons	
Level 1-9/10 Fader	Level [1]-[9/10] fader	
MAIN All	Buttons and knobs in AUDIO OUTPUT section	
SETUP Button	MAIN [SETUP] button	
SOLO Button	MAIN [SOLO] button	
MUTE Button	MAIN [MUTE] button	
Level Fader	MAIN [Level] fader	
AUX 1 Knob	[AUX 1] knob	
AUX 2 Knob	[AUX 2] knob	
USB OUT Knob	[USB OUT] knob	
STREAM/RECORD Knob	[STREAM/RECORD] knob	
AUDIO EFFECT All	Buttons in AUDIO EFFECT section	
SETUP Button	AUDIO EFFECT [SETUP] button	
AUDIO EFFECT 1-4 Button	AUDIO EFFECT [1]-[4] button	
AUDIO PLAYER All	Buttons in AUDIO PLAYER section	
SETUP Button	AUDIO PLAYER [SETUP] button	
AUDIO PLAYER 1-8 Pad	AUDIO PLAYER [1]-[8] pads	
Level Knob	AUDIO PLAYER [LEVEL] knob	

Menu item	Value (bold text: default value)	Explanation	
AUX Operation Target	AUX 1 , AUX 2, AUX 3	Sets the AUX bus that's operated by the VIDEO SWITCHER [1]–[8] buttons.	
AUX Linked PGM	Specifies whether the same video as the final output is sent to the AUX bus (AUX link).		
	Off	Use the VIDEO SWITCHER [1]–[8] buttons to select the video of the AUX bus. When selecting a video that is not assigned to Input 1–8, set this in "AUX 1–3 Source" under the Video Assign menu.	
	Auto Link Manual Link	AUX link is enabled, and the same video as the final output is sent to the AUX bus. Temporarily disabling AUX link When you press a VIDEO SWITCHER [1]–[8] button, the selection of the VIDEO SWITCHER [1]–[8] button is enabled (lit green). You can select the video you want to send to the AUX bus. Re-enabling AUX link	
	Auto Link	When you operate the [AUTO] button etc. to switch the final output video, AUX link is automatically enabled.	
	Manual Link	When you press the VIDEO SWITCHER [1]–[8] button that is currently selected (lit green), AUX link is enabled.	
AUX 1–3	OFF, ON	When this is "ON", the AUX link for AUX 1–3 is enabled.	
Output Fade Assign	Specifies the function of the [OUTPUT FADE] button.		
Time	0.0–1.0–4.0sec	Sets the fade-in/out time.	
Video Fade	N/A, Black , White, AUX 1–3	The final output video is faded-in/out to the specified video. * The AUX 1–3 Source setting is shown in the Video Assign menu for AUX 1–3.	
Audio Fade	OFF, ON	When this is set to "ON", the output audio also fades in/out along with the video.	
User Assign	Specifies the function that is assigned to the USER [1]–[4] button.		
Jump To Setup	Enter	Jumps to the setup screen.	
User 1–4	Category	Value	Explanation
	N/A	---	No function is assigned.
	Freeze	---	Turns the freeze function on/off.
	Auto Switching	Auto Switching	Turns the auto switching function on/off.
		Beat Sync Tap	Use this for tap input of the tempo when using beat sync. You can fine-tune the auto-detected beats or set the tempo manually.
	Input Assign	Input 1–8	Each time you press a button, the video source assigned to the specified VIDEO SWITCHER button switches to the following sources in order: [HDMI 1 → 6] → [SDI 1 → 6] → [STILL 1 → 16].
	Still Output	Still 1–16	Pauses the normal output, and previews or final outputs a cut of the still image.
	Video Player Output	---	Pauses the normal output, and cuts to the preview/final output of the video player image.
	Scene Memory	Memory 1–32	Recalls a scene memory. Long-press to save the current settings to a scene memory.
		Normal	Each time you press a button, the final output switches from Input 1–8 in sequential order.
	Input Scan	Reverse	Each time you press a button, the final output switches from Input 1–8 in reverse order.
		Normal	Each time you press a button, scene memories 1–32 are recalled in sequential order.
	Scene Memory Scan	Reverse	Each time you press a button, scene memories are recalled in reverse order from 32 through 1.
		Normal	The PinP&Key 1–4 inset screen videos switch between HDMI 1 → 6, SDI 1 → 6 and STILL 1 → 16 in order each time you press the button.
	PinP&Key 1–4 Scan	Reverse	The PinP&Key 1–4 inset screen videos switch between STILL 16 → 1, SDI 6 → 1 and HDMI 6 → 1 in order each time you press the button.
		Normal	The DSK 1 and 2 caption videos switch between HDMI 1 → 6, SDI 1 → 6 and STILL 1 → 16 in order each time you press the button.
	DSK 1, 2 Scan	Reverse	The DSK 1 and 2 caption videos switch between STILL 16 → 1, SDI 6 → 1 and HDMI 6 → 1 in order each time you press the button.
		Normal	Controls the recorder's video record start/stop if a recorder that supports REC control functionality is connected.
	External Rec Control	---	Controls the recorder's video record start/stop if a recorder that supports REC control functionality is connected.
	Macro Execute	Macro 1–100	Executes a macro (a series of recorded operations).
	Sequencer	---	Turns the sequencer function on/off.
	Stream/Record	Setup	Shows the streaming/recording setup screen.
		Start/Stop	Starts/stops streaming or recording.
		Safety Image	Turns the safety delay function on/off.
Video Player/SRT In	Setup	Shows the video player setup screen.	
	Start/Pause/Stop	Starts/pauses video playback. Long-press the button to stop playback.	
GPO (One Shot)	GPO 1–16	Outputs a control signal for 0.5 seconds.	
GPO (Alternate)	GPO 1–16	The control signal output is switched on/off while the button is pressed.	

Menu item	Value (bold text: default value)	Explanation	
User 1–4	Camera Control	Mode	Turns the camera control on/off. When this is on, the VIDEO SWITCHER [1]–[8] buttons can be used to recall the presets.
		Pan Left	Pans the camera to the left.
		Pan Right	Pans the camera to the right.
		Tilt Down	Pans the camera down.
		Tilt Up	Pans the camera up.
		Zoom Wide (Slow)	Zooms out at low speed.
		Zoom Wide (Fast)	Zooms out at high speed.
		Zoom Tele (Slow)	Zooms in at low speed.
		Zoom Tele (Fast)	Zooms in at high speed.
		Focus Near	Moves the focus closer.
		Focus Far	Moves the focus farther away.
		Auto Focus	Turns the camera auto focus on/off.
	Auto Exposure	Turns the camera auto-exposure on/off.	
	Graphics Presenter	Select Next Content, Select Content 1–124, Hide Front Contents, Hide Background Contents, ON AIR Switch	Sends commands for the Graphics Presenter dedicated app.
System	Bluetooth Control	Press the button to toggle Bluetooth on/off. Long-press the button to pair with a Bluetooth device.	
	Effects Transition Sync	Press the button to toggle Effects Transition Sync on/off.	
	Panel Operation	Press the button to switch the Panel Operation.	
Audio Effect Assign	Specifies the function that is assigned to the AUDIO EFFECT [1]–[4] button.		
Jump To Setup	Enter	Jumps to the setup screen.	
Audio Effect 1–4	Category	Value	Explanation
	N/A	---	No function is assigned.
	Audio Input Mute	(*33)	Turns the mute function on/off for the input audio.
	Audio Output Mute	Main Bus, AUX 1–3 Bus, USB Out, Stream/Record	Turns the mute function on/off for the output audio.
	Audio Input Solo	(*33)	Turns the solo function on/off for the input audio.
	Audio Output Solo	Main Bus, AUX 1–3 Bus	Turns the solo function on/off for the output audio.
	High Pass Filter	(*33)	Turns the high pass filter function on/off.
	Echo Canceller	Audio In 1–2	Turns the echo canceller function on/off.
	Anti-Feedback	Audio In 1–2	Turns the anti-feedback function on/off.
	Noise Gate	(*33)	Turns the noise gate function on/off.
	De-Esser	Audio In 1–6	Turns the de-esser function on/off.
	Compressor	(*33)	Turns the compressor function on/off.
	Audio Input Equalizer	(*33)	Turns the equalizer function on/off for the output audio.
	Audio Output Equalizer	Main Bus, AUX 1–3 Bus, USB Out, Stream/Record	Turns the equalizer function on/off for the input audio.
	Audio Output GEQ	Main Bus, AUX 1–3 Bus	Turns the graphic equalizer function on/off.
	Voice Changer	Audio In 1–2	Turns the voice changer function on/off.
	Auto Mixing	---	Turns the auto mixing function on/off.
	Reverb(Momentary)	---	Reverb turns on only while you press the button.
	Reverb(Alternate)	---	Turns reverb on/off.
	Compressor/Limiter	Main Bus, AUX 1–3 Bus	Turns the compressor/limiter function on/off.
Loudness AGC	---	Turns Loudness AGC on/off.	
Adaptive NR	---	Turns Adaptive NR on/off.	

(*33) Audio In 1–9/10, USB In, Bluetooth In, Audio Player, HDMI 1–6, SDI 1–6, V.Player/SRT In (Depending on the “Video Player/SRT In” → “Type” setting, either V.Player or SRT in is displayed.)

Menu List

Menu item	Value (bold text: default value)	Explanation	
Monitor Assign	Specifies the function that is assigned to the MONITOR [1]–[4] button.		
Jump To Setup	Enter	Jumps to the setup screen.	
Monitor 1–4	Value	Explanation	
	N/A	No video is assigned.	
	Multi-View	The final output video, preview output video and the videos allocated to the VIDEO SWITCHER [1]–[8] buttons are shown in sections of the display (multi-view).	
	Input-View	The input video from the HDMI IN connectors and the SDI IN connectors are shown as 16 separate sections on the screen	
	Still-View	Shows the loaded still images in 16 separate sections on the screen.	
	Program	Shows the final output video.	
	Sub Program	Shows the Sub Program bus video.	
	Preview	Shows the preview output video.	
	AUX 1–3	Shows the AUX bus video.	
DSK 1, 2 Source	Shows the DSK video source.		
LED Dimmer	1–8	Adjusts the brightness when the buttons or indicators are lit.	
LCD Dimmer	1–8	Adjusts the brightness of this unit's monitor.	
LCD Menu	Left, Right	This sets where the menu is displayed.	
Tally Frame	Sets whether to display the tally frame or not in the monitor.		
Multi-View	OFF, ON	Turns the tally frame on/off in the Multi-view.	
Input-View	OFF, ON	Turns the tally frame on/off in the Input-view.	
Still-View	OFF, ON	Turns the tally frame on/off in the Still-view.	
AUX/Source Indicator	Sets whether to display the AUX/Source indicators in the monitor.		
		Color	Explanation
		Yellow	Shows that this has been selected as an inset screen for the PinP & KEY.
		Magenta	Shows that this has been selected as a DSK video source.
		Green	Shows that this has been selected as an AUX bus video source.
	Multi-View	OFF, ON	Turns the indicator on/off for multi-view.
	Input-View	OFF, ON	Turns the indicator on/off for Input-view.
Still-View	OFF, ON	Turns the indicator on/off for Still-view.	
External Rec Indicator	Sets whether to display the External Rec indicator in the monitor.		
	When this is "ON", a REC indicator showing that the camera's REC button has been pressed is displayed, if the unit is connected to a camera that supports the REC status function.		
Multi-View	OFF, ON	Turns the indicator on/off for multi-view.	
Input-View	OFF, ON	Turns the indicator on/off for Input-view.	
Audio Level Meter	Specifies whether to display the audio level meter in the monitor.		
Multi-View	OFF, ON	Turns the indicator on/off for multi-view.	
Input-View	OFF, ON	Turns the indicator on/off for Input-view.	
Level Meter Position			
HDMI In 1–6	Pre Fader(PFL) Post Fader(AFL)	Sets the display position of the audio level meter.	
SDI In 1–6			
Video Player/SRT In			
Audio In 1–9/10			
USB In			
Bluetooth In			
Audio Player			
Main Bus			
AUX 1–3 Bus			
USB Out			
Stream/Record			
Monitor Bus			

Menu item	Value (bold text: default value)	Explanation
Preview Label	Specifies whether to display the label in the monitor.	
Jump To Setup	Enter	Jumps to the setup screen.
Multi-View	OFF, ON	Turns the label view on/off in the Multi-view.
Input-View	OFF, ON	Turns the label view on/off in the Input-view.
Still-View	OFF, ON	Turns the label view on/off in the Still-view.
Label Edit	Menu item	Value
	Jump To Setup	Enter
	HDMI In 1–HDMI In 6	HDMI 1–HDMI 6
	SDI In 1–SDI In 6	SDI 1–SDI 6
	Still 1–Still 16	Still 1–Still 16
	Video Player	V.Player
	SRT In	SRT In
	Program	PGM
	Sub Program	SUB PGM
	Preview	PVW
	AUX 1–3	AUX 1–3
DSK 1, 2 Source	DSK 1, 2	
	Edit the label name shown in the monitor. Press the [VALUE] knob to access the Label Edit screen.	
Label Size	Small, Normal	Specifies the text size of the label shown in the monitor.
Multi-View Layout	Specifies the videos to be shown in the PVW section (Left) and PGM section (Right) in the multi-view.	
Left Right	Program	Final output video. This is the default setting for "Right".
	Sub Program	Sub Program bus video
	Preview	Preview output video. This is the default setting for "Left".
	AUX 1–3	AUX bus video
	DSK 1, 2 Source	DSK video source
	Black	Black screen
Input-View Layout	Configures the layout in input-view.	
Jump To Setup	Enter	Jumps to the setup screen.
Input 1–16	HDMI 1–6, SDI 1–6, Still 1–16 V.Player/SRT In (*34) Input 1–8 Stream/Record Status 1–2 Date&Time(Analog/Digital) (*35) N/A	Sets the video to display for Input 1–16.
Auto Input Detect	OFF , ON	Turns the auto input detect function on/off. When this is "ON", input is automatically detected, and the video is switched when input from the final output video is interrupted.
Auto Fan Control	OFF, ON	Turns the auto fan control function on/off. When this is "ON", this function controls the fan according to the internal temperature of this unit.
Test Pattern	Specifies the test pattern.	
Pattern	Off , Color Bars 75%, Color Bars100%, Ramp, Step, Hatch, Diamond, Circle, Color Bars 75%-SP, Color Bars100%-SP, Ramp-SP, Step-SP, Hatch-SP	Selects the test pattern to display.
Motion	Off , Slow, Fast	Specifies the scroll speed of the test pattern.
Test Tone	Specifies the test tone.	
Level	Off , -20, -10, 0dB	Adjusts the test tone volume.
Frequency L	500Hz, 1kHz , 2kHz	Specifies the frequency of the test tone for the L-channel.
Frequency R	500Hz, 1kHz , 2kHz	Specifies the frequency of the test tone for the R-channel.
Shut Down	Exec	Shuts down this unit.
Factory Reset	Exec	Returns the unit to its factory defaults.
System Information	—	Displays the version of the system program.

(*34) Depending on the "Video Player/SRT In" → "Type" setting, either V.Player or SRT in is displayed.

(*35) The analog/digital display changes in the "System → Date&Time → Clock Display Type" setting.

About Rack Mounting

Attaching the included rack-mount angles lets you install the VR-120HD in a 19-inch rack.

Attaching the Rack-Mount Angles

1. Turn off the power to the VR-120HD and disconnect the power cord and all connection cables.
2. Use the included mounting screws (three per side) to attach the rack-mount angles.

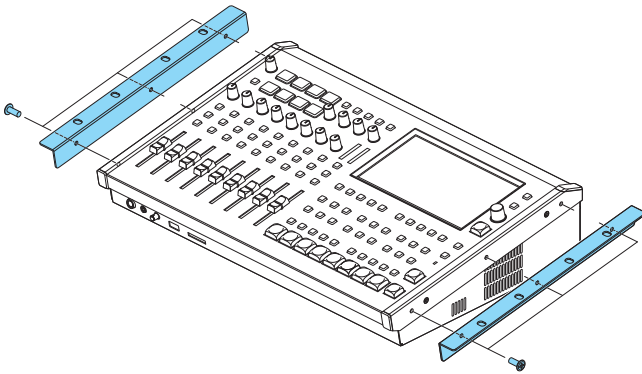

* Both of the rack-mount angles have the same shape; there is no difference between left and right.

NOTE

When uninstalling the rack-mount angles

Before uninstalling the rack-mount angles, turn off the power to the VR-120HD and disconnect the power cord and all connector cables.

Important Notes on Rack Mounting

- Before mounting, turn off the power to the VR-120HD and detach the power cord and all connection cables.
- When mounting the unit, take care not to pinch your fingers etc.
- To prevent incorrect operation or malfunction, take care not to subject areas protruding beyond the rack to accidental impact.
- To ensure room for connectors and cables, leave 2U of clearance above the unit.
- Use all threaded holes (at 2 locations on each side, for a total of 4) to secure the unit to the rack using screws. Screws for rack mounting are not included.
- Never transport the rack with the unit installed in it. The impact of shaking or vibration might deform the rack-mount angles.
- When mounting the VR-120HD in a rack, pay attention to the following points to ensure efficient cooling.
 - Install in a well-ventilated location.
 - Avoid blocking the cooling-fan intake and exhaust ports on the side panels of the VR-120HD.
 - Avoid mounting the unit in a sealed-type rack. Warm air within the rack cannot escape, making efficient cooling impossible.
 - If the back of the rack cannot be opened, install an exhaust port or ventilation fan at the top back surface of the rack where warm air collects.
- Also read the “Placement” (the leaflet “USING THE UNIT SAFELY” and the “Startup Guide”) under “IMPORTANT NOTES”.

Main Specifications

Video																																																																						
Video Processing	4:2:2 (Y/Pb/Pr), 8-bit																																																																					
Number of Video Channels	12 channels																																																																					
Input Connectors	HDMI IN 1–6	HDMI type A x 6 * HDCP Supported, Multi-format Supported																																																																				
	SDI IN 1–6	BNC type x 6 * Conforms to SMPTE 424M (SMPTE 425M-AB), 292M																																																																				
Output Connectors	HDMI OUT 1–3	HDMI type A x 3 * HDCP Supported																																																																				
	SDI OUT 1–3	BNC type x 3 * Conforms to SMPTE 424M (SMPTE 425M-AB), 292M																																																																				
	USB STREAM	USB Type-C®																																																																				
Video Input Formats	HDMI IN 1–6	<table border="1"> <thead> <tr> <th colspan="4">Frame Rate</th> </tr> <tr> <th colspan="2">59.94 Hz, 60 Hz</th> <th colspan="2">50 Hz</th> </tr> </thead> <tbody> <tr> <td>480/59.94i</td> <td>480/59.94p</td> <td>576/50i</td> <td>576/50p</td> </tr> <tr> <td colspan="2">720/59.94p</td> <td colspan="2">720/50p</td> </tr> <tr> <td>1080/59.94i</td> <td>1080/59.94p</td> <td>1080/50i</td> <td>1080/50p</td> </tr> <tr> <td colspan="2">1080/60p</td> <td colspan="2">1080/25p</td> </tr> <tr> <td>1080/29.97p</td> <td>1080/30p</td> <td>1080/23.98p</td> <td>1080/24p</td> </tr> <tr> <td>1080/23.98p</td> <td>1080/24p</td> <td colspan="2">VGA (640×480/60 Hz)</td> </tr> <tr> <td colspan="2">VGA (640×480/60 Hz)</td> <td colspan="2">SVGA (800×600/60 Hz)</td> </tr> <tr> <td colspan="2">SVGA (800×600/60 Hz)</td> <td colspan="2">XGA (1024×768/60 Hz)</td> </tr> <tr> <td colspan="2">XGA (1024×768/60 Hz)</td> <td colspan="2">WXGA (1280×800/60 Hz)</td> </tr> <tr> <td colspan="2">WXGA (1280×800/60 Hz)</td> <td colspan="2">SXGA (1280×1024/60 Hz)</td> </tr> <tr> <td colspan="2">SXGA (1280×1024/60 Hz)</td> <td colspan="2">FWXGA (1366×768/60 Hz)</td> </tr> <tr> <td colspan="2">FWXGA (1366×768/60 Hz)</td> <td colspan="2">SXGA+ (1400×1050/60 Hz)</td> </tr> <tr> <td colspan="2">SXGA+ (1400×1050/60 Hz)</td> <td colspan="2">UXGA (1600×1200/60 Hz)</td> </tr> <tr> <td colspan="2">UXGA (1600×1200/60 Hz)</td> <td colspan="2">WUXGA (1920×1200/60 Hz)</td> </tr> <tr> <td colspan="2">WUXGA (1920×1200/60 Hz)</td> <td colspan="2"></td> </tr> </tbody> </table> <p>* The refresh rate is the maximum value of each resolution. * Conforms to CEA-861-E, VESA DMT Version 1.0 Revision 11. * 1920 x 1200/60 Hz: Reduced blanking * The input interlaced video signal is converted to progressive video signal by internal processing. * The input refresh rates of SVGA (800 x 600)–SXGA+ (1400 x 1050) are 75 Hz when the unit's frame rate setting is 50 Hz. * HDMI IN 6 support Roland FILL+KEY signal * 1 Frame Rate = 59.94 Hz, 60 Hz * 2 Frame Rate = 50 Hz</p>	Frame Rate				59.94 Hz, 60 Hz		50 Hz		480/59.94i	480/59.94p	576/50i	576/50p	720/59.94p		720/50p		1080/59.94i	1080/59.94p	1080/50i	1080/50p	1080/60p		1080/25p		1080/29.97p	1080/30p	1080/23.98p	1080/24p	1080/23.98p	1080/24p	VGA (640×480/60 Hz)		VGA (640×480/60 Hz)		SVGA (800×600/60 Hz)		SVGA (800×600/60 Hz)		XGA (1024×768/60 Hz)		XGA (1024×768/60 Hz)		WXGA (1280×800/60 Hz)		WXGA (1280×800/60 Hz)		SXGA (1280×1024/60 Hz)		SXGA (1280×1024/60 Hz)		FWXGA (1366×768/60 Hz)		FWXGA (1366×768/60 Hz)		SXGA+ (1400×1050/60 Hz)		SXGA+ (1400×1050/60 Hz)		UXGA (1600×1200/60 Hz)		UXGA (1600×1200/60 Hz)		WUXGA (1920×1200/60 Hz)		WUXGA (1920×1200/60 Hz)			
	Frame Rate																																																																					
59.94 Hz, 60 Hz		50 Hz																																																																				
480/59.94i	480/59.94p	576/50i	576/50p																																																																			
720/59.94p		720/50p																																																																				
1080/59.94i	1080/59.94p	1080/50i	1080/50p																																																																			
1080/60p		1080/25p																																																																				
1080/29.97p	1080/30p	1080/23.98p	1080/24p																																																																			
1080/23.98p	1080/24p	VGA (640×480/60 Hz)																																																																				
VGA (640×480/60 Hz)		SVGA (800×600/60 Hz)																																																																				
SVGA (800×600/60 Hz)		XGA (1024×768/60 Hz)																																																																				
XGA (1024×768/60 Hz)		WXGA (1280×800/60 Hz)																																																																				
WXGA (1280×800/60 Hz)		SXGA (1280×1024/60 Hz)																																																																				
SXGA (1280×1024/60 Hz)		FWXGA (1366×768/60 Hz)																																																																				
FWXGA (1366×768/60 Hz)		SXGA+ (1400×1050/60 Hz)																																																																				
SXGA+ (1400×1050/60 Hz)		UXGA (1600×1200/60 Hz)																																																																				
UXGA (1600×1200/60 Hz)		WUXGA (1920×1200/60 Hz)																																																																				
WUXGA (1920×1200/60 Hz)																																																																						
	SDI IN 1–6	<table border="1"> <thead> <tr> <th colspan="2">Output Format : 720p</th> <th colspan="2">Output Format : 1080i or 1080p</th> </tr> <tr> <th colspan="2">Frame Rate</th> <th colspan="2">Frame Rate</th> </tr> <tr> <th>59.94 Hz, 60 Hz</th> <th>50 Hz</th> <th>59.94 Hz, 60 Hz</th> <th>50 Hz</th> </tr> </thead> <tbody> <tr> <td>720/59.94p</td> <td>720/50p</td> <td>1080/59.94i</td> <td>1080/59.94p</td> </tr> <tr> <td></td> <td></td> <td>1080/50i</td> <td>1080/50p</td> </tr> <tr> <td></td> <td></td> <td>1080/60p</td> <td>1080/25p</td> </tr> <tr> <td></td> <td></td> <td>1080/29.97p</td> <td>1080/30p</td> </tr> <tr> <td></td> <td></td> <td>1080/23.98p</td> <td>1080/24p</td> </tr> <tr> <td></td> <td></td> <td></td> <td>1080/23.98p</td> </tr> <tr> <td></td> <td></td> <td></td> <td>1080/24p</td> </tr> </tbody> </table> <p>* The input interlaced video signal is converted to progressive video signal by internal processing.</p>	Output Format : 720p		Output Format : 1080i or 1080p		Frame Rate		Frame Rate		59.94 Hz, 60 Hz	50 Hz	59.94 Hz, 60 Hz	50 Hz	720/59.94p	720/50p	1080/59.94i	1080/59.94p			1080/50i	1080/50p			1080/60p	1080/25p			1080/29.97p	1080/30p			1080/23.98p	1080/24p				1080/23.98p				1080/24p																												
Output Format : 720p		Output Format : 1080i or 1080p																																																																				
Frame Rate		Frame Rate																																																																				
59.94 Hz, 60 Hz	50 Hz	59.94 Hz, 60 Hz	50 Hz																																																																			
720/59.94p	720/50p	1080/59.94i	1080/59.94p																																																																			
		1080/50i	1080/50p																																																																			
		1080/60p	1080/25p																																																																			
		1080/29.97p	1080/30p																																																																			
		1080/23.98p	1080/24p																																																																			
			1080/23.98p																																																																			
			1080/24p																																																																			
Video Output Formats	HDMI OUT 1–3 SDI OUT 1–3	<table border="1"> <thead> <tr> <th rowspan="2">Output Format</th> <th colspan="3">Frame Rate</th> </tr> <tr> <th>59.94 Hz</th> <th>60 Hz</th> <th>50 Hz</th> </tr> </thead> <tbody> <tr> <td>720p</td> <td>720/59.94p</td> <td>720/60p</td> <td>720/50p</td> </tr> <tr> <td>1080i</td> <td>1080/59.94i</td> <td>1080/60i</td> <td>1080/50i</td> </tr> <tr> <td>1080p</td> <td>1080/59.94p</td> <td>1080/60p</td> <td>1080/50p</td> </tr> </tbody> </table> <table border="1"> <thead> <tr> <th rowspan="2">Output Format</th> <th colspan="5">Frame Rate</th> </tr> <tr> <th>29.97 Hz</th> <th>30 Hz</th> <th>25 Hz</th> <th>23.98 Hz</th> <th>24 Hz</th> </tr> </thead> <tbody> <tr> <td>1080p</td> <td>1080/29.97p</td> <td>1080/30p</td> <td>1080/25p</td> <td>1080/23.98p</td> <td>1080/24p</td> </tr> </tbody> </table>	Output Format	Frame Rate			59.94 Hz	60 Hz	50 Hz	720p	720/59.94p	720/60p	720/50p	1080i	1080/59.94i	1080/60i	1080/50i	1080p	1080/59.94p	1080/60p	1080/50p	Output Format	Frame Rate					29.97 Hz	30 Hz	25 Hz	23.98 Hz	24 Hz	1080p	1080/29.97p	1080/30p	1080/25p	1080/23.98p	1080/24p																																
Output Format	Frame Rate																																																																					
	59.94 Hz	60 Hz	50 Hz																																																																			
720p	720/59.94p	720/60p	720/50p																																																																			
1080i	1080/59.94i	1080/60i	1080/50i																																																																			
1080p	1080/59.94p	1080/60p	1080/50p																																																																			
Output Format	Frame Rate																																																																					
	29.97 Hz	30 Hz	25 Hz	23.98 Hz	24 Hz																																																																	
1080p	1080/29.97p	1080/30p	1080/25p	1080/23.98p	1080/24p																																																																	

Video Output Formats	USB STREAM	Frame Rate (USB OUT)				
		59.94 Hz	60 Hz	29.97 Hz	30 Hz	
		1080/59.94p	1080/60p	1080/29.97p	1080/30p	
		720/59.94p	720/60p	720/29.97p	720/30p	
		640x480/59.94p	640x480/60p	640x480/29.97p	640x480/30p	
		Frame Rate (USB OUT)				
		50 Hz	25 Hz	23.98 Hz	24 Hz	
		1080/50p	1080/25p	1080/23.98p	1080/24p	
		720/50p	720/25p	720/23.98p	720/24p	
		640x480/50p	640x480/25p	640x480/23.98p	640x480/24p	
* Uncompressed format (YUY2) and Compressed format (Motion JPEG) supported.						
Video Output Formats	DIRECT STREAM	Output Format	Frame Rate (Stream/Record)			
			59.94 Hz	60 Hz	29.97 Hz	30 Hz
		720p	720/59.94p	720/60p	720/29.97p	720/30p
		1080p	1080/59.94p	1080/60p	1080/29.97p	1080/30p
		Output Format	Frame Rate (Stream/Record)			
			50 Hz	25 Hz	23.98 Hz	24 Hz
		720p	720/50p	720/25p		
		1080p	1080/50p	1080/25p	1080/23.98p	1080/24p
Stream and Record formats	Audio Video	Protocols: RTMP, RTMPS, SRT (Caller, Listener) Container: FLV (RTMP, RTMPS), MPEG2-TS (SRT) Recording File Format: MP4 Codec: H.264, target bitrate up to 20,000 kbps AAC-LC, 16 bits, 48 kHz, stereo, target bitrate up to 384 kbps * When the format of either Stream & Record or Video Player/SRT In exceeds 1080/30p, the Stream & Record and Video Player/SRT In functions cannot be used simultaneously. * When the sum of the bitrate for Stream & Record and Video Player/SRT In exceeds 20,000 kbps, the Stream & Record and Video Player/SRT In functions cannot be used simultaneously.				
	Audio	Recording File Format: WAV Codec: Linear PCM, 16 bits, 48 kHz, stereo				
Video Player/SRT In	Video Player	File Format: MP4 Codec: H.264, Average bit rate of 20,000 kbps or less, up to 1080/60p AAC-LC, 16 bits, 48 kHz, stereo				
	SRT In	Protocol: SRT (Caller, Listener) Container: MPEG2-TS Codec: H.264, Average bit rate of 20,000 kbps or less, up to 1080/60p AAC-LC, 16 bits, 48 kHz, stereo * When the format of either Stream & Record or Video Player/SRT In exceeds 1080/30p, the Stream & Record and Video Player/SRT In functions cannot be used simultaneously. * When the sum of the bitrate for Stream & Record and Video Player/SRT In exceeds 20,000 kbps, the Stream & Record and Video Player/SRT In functions cannot be used simultaneously.				
Still Image	File Format	Bitmap File (.bmp) Maximum 1920 x 1080 pixels, 24-bit color, uncompressed. PNG File (.png) Maximum 1920 x 1080 pixels, 24-bit color JPEG File (.jpg, .jpeg) Maximum 1920 x 1080 pixels, 24-bit color * It can be stored up to 16 files in the internal memory. * It can be exported in the SD Card and USB flash drive. * PNG alpha channel supported.				
Video Effects	Transition	Cut, Mix (Dissolve/FAM/NAM), WIPE (8 types), SPLIT (2 types)				
	Composition	Composition: PinP x 4 (Square, Circle, Diamond), Keyer x 4 (Luminance Key, Chroma Key), DSK x 2 (Luminance Key, Chroma Key, Alpha Key, External Key), Roland FILL+KEY Mode				
	Other	Multi-View (3 types), Flip horizontal, Flip vertical, Still Image capture, Still Image playback, Output fade (Audio, Video: White or Black), Test pattern output, Stream Delay				

Audio			
Audio Processing	Sample rate	24 bits, 48 kHz	
Number of Audio Channels	42 channels		
Audio Formats	USB STREAM (input/output)	Linear PCM, 16 bits, 48 kHz, 2 ch	
	Bluetooth In (input)	Linear PCM, 16 bits, 48 kHz, 2 ch	
	HDMI IN	Linear PCM, 24 bits, 48 kHz, 2 ch	
	HDMI OUT	Linear PCM, 24 bits, 48 kHz, 8 ch	
	SDI IN	Linear PCM, 24 bits, 48 kHz, 2 ch (Conforms to SMPTE 299M)	
	SDI OUT	Linear PCM, 24 bits, 48 kHz, 8 ch (Conforms to SMPTE 299M)	
Audio Player	File Format	WAV (Linear PCM, 16 bits, 48 kHz/44.1 kHz, stereo) * It can be stored up to 16 tracks in the internal memory.	
Audio Effects	Channel Effects	High pass filter, Echo canceller, Anti-feedback, Noise gate, De-esser, Compressor, 4-Band equalizer, Voice changer, Delay, Auto mixing	
	Master Effects	Reverb, 4-Band equalizer, Compressor/Limiter, Loudness Auto Gain Control, Adaptive Noise Reduction, Low Frequency Cut, 15-Band GEQ, Delay	
	Other	Output fade, Test tone output	
Input Connectors	Analog	AUDIO IN 1–6	Combo type (XLR, 1/4-inch TRS phone), phantom power DC 48 V (unloaded maximum), 14 mA (maximum load)
		AUDIO IN 7/L, 8/R	RCA phono type
		AUDIO IN 9/L, 10/R	
	Digital	USB STREAM	USB Type-C®
		Bluetooth In	
		HDMI IN 1–6	HDMI type A x 6
	SDI IN 1–6	BNC type x 6	
Output Connectors	Analog	AUDIO OUT 1	XLR type
		AUDIO OUT 2	
		AUDIO OUT 3	RCA phono type
		PHONES	Stereo 1/4-inch phone type, Stereo miniature phone type
	Digital	USB STREAM	USB Type-C®
		HDMI OUT 1–3	HDMI type A x 3
SDI OUT 1–3		BNC type x 3	
Nominal Input Level	AUDIO IN 1–6	-64–+4 dBu (Maximum: +24 dBu)	
	AUDIO IN 7/L, 8/R	-10 dBu (Maximum: +10 dBu)	
	AUDIO IN 9/L, 10/R		
Input Impedance	AUDIO IN 1–6	30 kΩ	
	AUDIO IN 7/L, 8/R	7 kΩ	
	AUDIO IN 9/L, 10/R		
Nominal Output Level	AUDIO OUT 1 (XLR)	+4 dBu (Maximum: +24 dBu)	
	AUDIO OUT 2 (XLR)		
	AUDIO OUT 3 (RCA)	-10 dBu (Maximum: +10 dBu)	
	PHONES	92 mW + 92 mW (32 Ω)	
Output Impedance	AUDIO OUT 1 (XLR)	600 Ω	
	AUDIO OUT 2 (XLR)		
	AUDIO OUT 3 (RCA)	1 kΩ	
	PHONES	56Ω	
Residual Noise Level (IHF-A, typ.)	AUDIO OUT 1 (XLR)	-92 dBu (All faders: Min)	
	AUDIO OUT 2 (XLR)	-89 dBu ([MAIN] Fader: Unity, Input faders: Unity only one AUDIO IN 1 Connector, Analog gain: Min)	
	* Input 150 Ω terminate	-62 dBu ([MAIN] Fader: Unity, Input faders: Unity only one AUDIO IN 1 Connector, Analog gain: Max)	
	AUDIO OUT 3 (RCA)	-101 dBu (All faders: Min)	
	* Input 150 Ω terminate	-100 dBu ([MAIN] Fader: Unity, Input faders: Unity only one AUDIO IN 1 jack, Analog gain: Min) -75 dBu ([MAIN] Fader: Unity, Input faders: Unity only one AUDIO IN 1 jack, Analog gain: Max)	

Other		
Recording Media	SDHC/SDXC card (commercially available)	* SDXC card is required for video recording.
	USB flash drive (commercially available)	
Other Connectors	USB HOST	USB A type (for USB flash drive, for remote control from USB numeric keypad)
	USB STREAM	USB STREAM: USB Type-C® (for remote control from PC and iPad, Graphics Presenter)
	Bluetooth connection	for remote control from iPad
	CTL/EXP 1, 2	1/4-inch TRS phone type (for remote control from footswitch and expression pedal)
	TALLY/GPIO	DB-25 type (Female)(Tally/GPO: 16, GPI: 8)
	RS-232	DB-9 type (Male) (for Remote Control)
	DIRECT STREAM	RJ45, 1000BASE-TX (for Live Streaming, SRT In/Out, and Remote Control)
	REFERENCE IN/THRU	BNC type * Black Burst (Sync to frames), Bi-Level, Tri-Level
Other Functions	Scene Memory (32 types), Macro Control (100 types), Sequencer Control (1,000 steps), Panel lock function, EDID Emulator, Auto Switching, Auto Input Detect, Smart Tally, Remote Camera Control (Up to 12 units), External Rec Control, Menu language (English, Japanese, Simplified chinese)	
Bluetooth Function	Ver 5.0	
	Profile Support	A2DP (Audio), GATT (MIDI over Bluetooth Low Energy)
	Codec	SBC (Support to the content protection of the SCMS-T method)
Display	Graphic Type, 7", Wide VGA (800 x 480 dots), backlite LCD (Color/Touch screen)	
Power Supply	AC adaptor	
Current Draw	3.0 A	
Power onsumption	69 W	
Operation Temperature	+0 to +40 degrees Celsius +32 to +104 degrees Fahrenheit	
Dimensions	437 (W) x 304 (D) x 109 (H) mm 17-1/4 (W) x 12 (D) x 4-5/16 (H) inches 482 (W) x 304 (D) x 109 (H) mm 19 (W) x 10 (D) x 4-1/16 (H) inches * When rack mount angles are fitted.	
Weight	5.3 kg, 11 lbs 11 oz (excluding AC adaptor)	
Accessories	Startup Guide, Leaflet "USING THE UNIT SAFELY", AC adaptor, Power cord, Rack-mount angle x 2 Rack-mount angle mounting screw x 6	
Options	Footswitch: BOSS FS-5U, FS-6, FS-7 Expression Pedal: EV-5, EV-30, BOSS FV-500L, FV-500H	

* 0 dBu = 0.775 Vrms

* This product is a Class A digital device under FCC part 15.

* This document explains the specifications of the product at the time that the document was issued. For the latest information, refer to the Roland website.

Dimensions

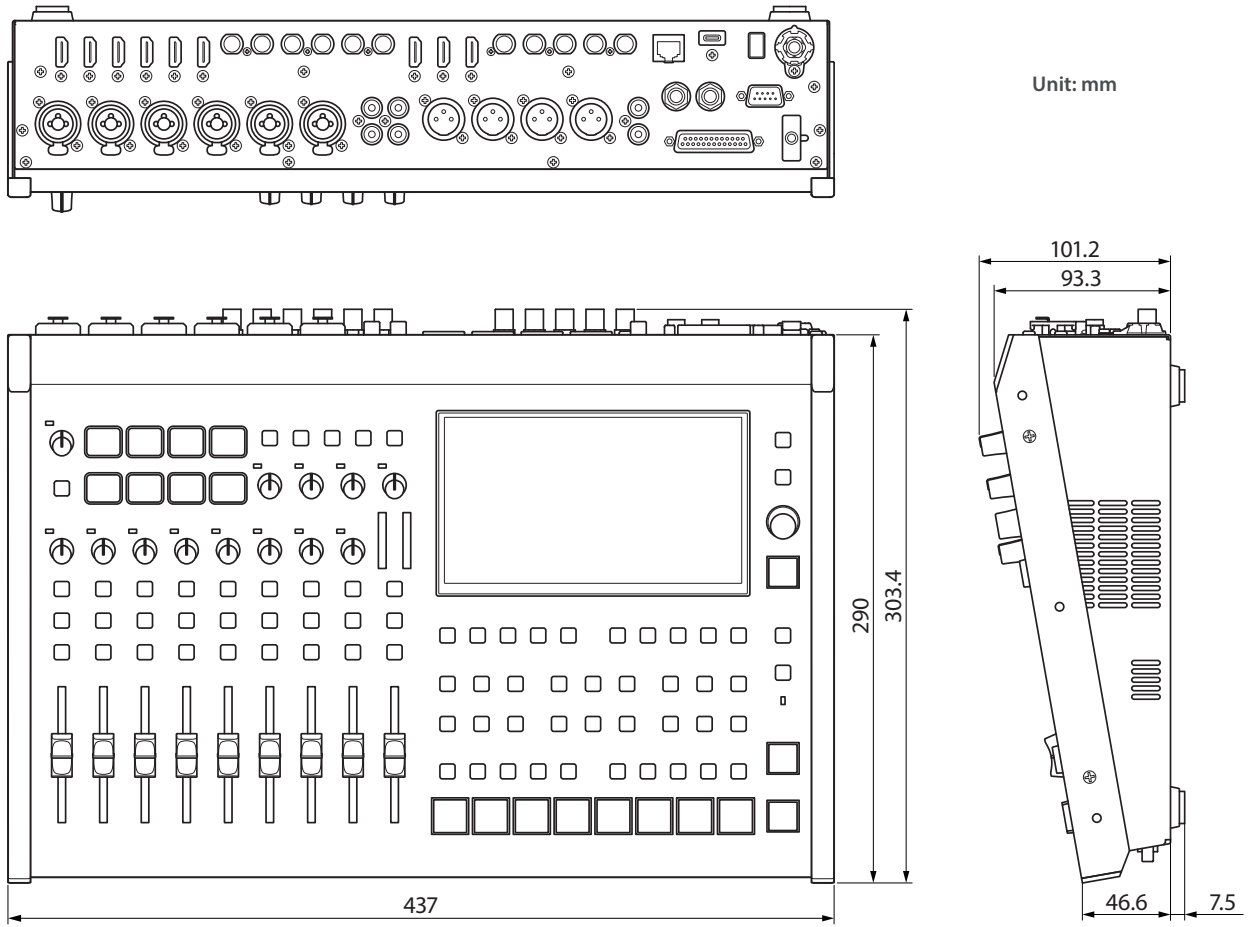

When rack-mount angles are attached

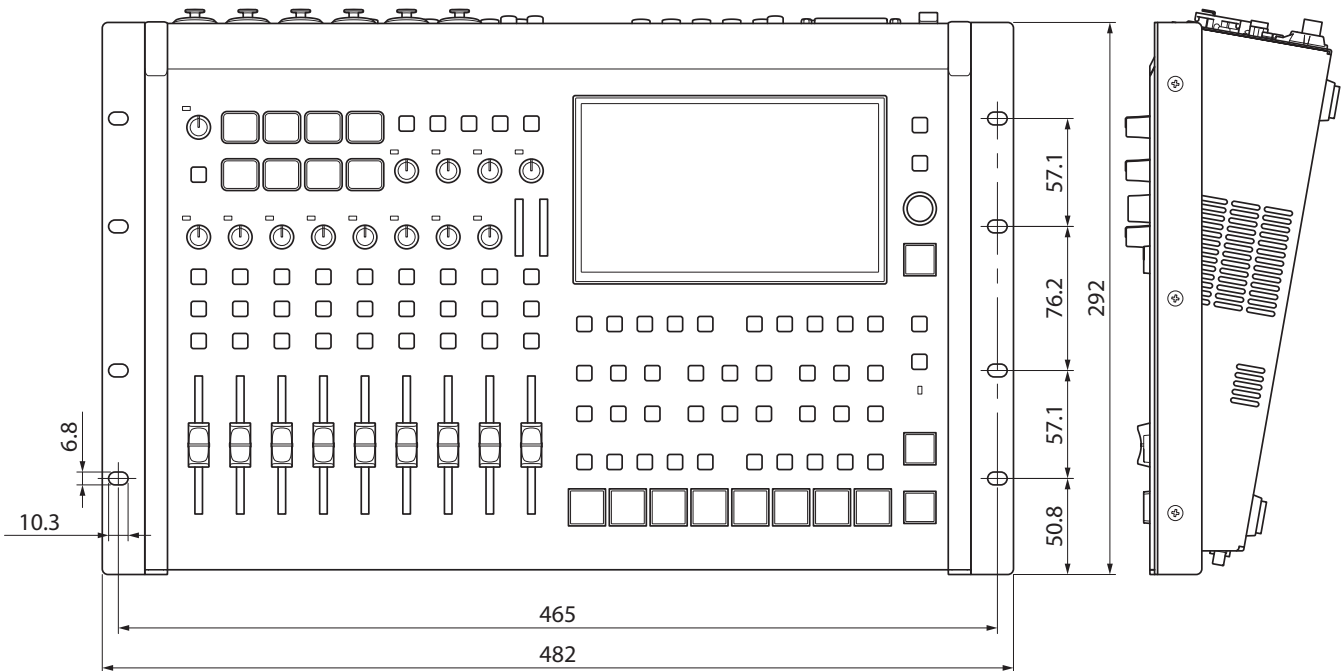

Video Block Diagram

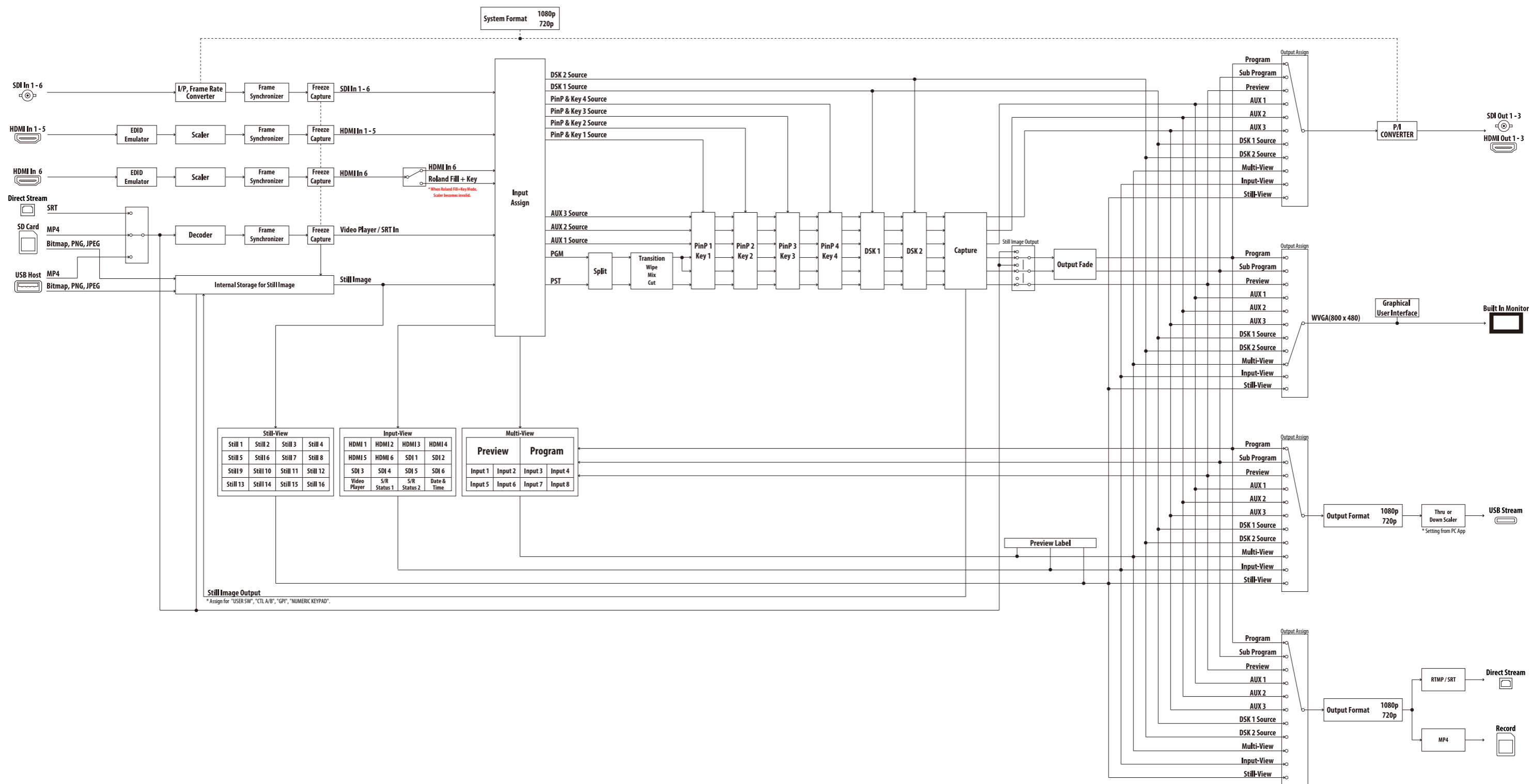

Audio Block Diagram

