

traulux

INTERACTIVE MONITORS

TX90 SERIES

TX6590 | TX7590 | TX8690



DISCOVER

Simply Better...

PHILOSOPHY

INDEX

1- . PRESENTATION.....	4
2- . HARDWARE.....	5
2.1- . Accessories Included.....	6
2.1.1- . Wall Mount.....	6
2.1.2- . Remote Control.....	6
2.2. Connections and Controls	7
2.3. Optional Modules.....	8
2.3.1- . Windows PC-OPS.....	8
• PC-OPS - Power On/Off	
• Working with a PC-OPS module and two interactive displays	
2.3.2- . ChromeBox.....	9
Settings.....	9
3- . SOFTWARE - ANDROID.....	10
3.1.Introduction.....	10
3.2. First Startup	11
3.3- . Menus.....	11
3.3.1. Floating Icon.....	11
3.3.2. HOME Menu.....	12
3.3.3- .Sidebar.....	13
3.4. Features.....	13
3.4.1- .Cut.....	13
3.4.2- . Active and split mode.....	15
3.4.3.Pen-NoteLayer.....	16
3.4.4. Whiteboard (S-Write).....	16
• Whiteboard Menu	
• Split Screen Writing	
• Background Setting	
3.4.5- . File explorer.....	19
3.4.6- . Freeze.....	19
3.4.7.Shortcuts.....	20
3.4.8- .Settings.....	20
• Network and Connections	
• Wallpaper	
• Language and Input Method	
• Date and Time	
• Security Settings	
• Power Settings	
• About	
• Other	

INDEX

3.4.9- .EsharePROMirroring.....	24
3.4.9.1. Application in the display.....	24
• Settings	
• Moderator Menu	
• Mirroring to other interactive displays	
3.4.9.2- .Mirroring from devices.....	26
• Download Site	
• Connection	
• Mirroring from a PC or laptop	
• Mirroring from an Android SmartPhone or Tablet	
• Mirroring from an iOS SmartPhone or Tablet	
• Display Group Settings	
3.4.10- .Apps.....	29
3.4.11- .Source.....	30
3.4.12- .Utilities.....	30
• Countdown	
• Eye Protection	
• Calculator	
• Vote	
• Screen Capture	
• Screen Recorder	
• Stopwatch	
• Spotlight	
• Touch Sound	
• Volume and Brightness Settings	
3.5- .Working with Office files – PDF.....	32
• Word – Power Point – Excel	
• PDF	
3.6. Working with Google Apps.....	34
3.6.1- .Gmail.....	34
3.6.2- .Google Drive.....	36
3.6.3- .Google Classroom.....	36
3.6.4- . Google earth.....	36
3.6.5- . Google Jamboard.....	36
3.6.6- . Google Meet.....	37
3.6.7- . Youtube.....	37
4. TECHNICAL DOCUMENTATION.....	38
4.1. Technical Specifications.....	39
4.2. Technical Drawings.....	40
4.3. RS232/IP Commands.....	43





**EVERYTHING YOU NEED
IN JUST ONE CLICK...**

TX90 SERIES TRAILUX

Simply Better

HARDWARE



Thank you for placing your trust in **TRAILUX** products. We hope that you are satisfied with your purchase and that you enjoy using this equipment for many years.

Our **“Simply Better”** philosophy is patent in each one of the processes, tools, and functions of this interactive panel.

Our development team, working closely with ICT experts and programmers, has endeavoured to create the most intuitive and simplest user interface possible.

The Android 9.0 operating system, with 8 Gb of RAM and 64 Gb of ROM, is perfectly equipped to handle practically any need you may encounter in the classroom or company, including for the first time a videoconferencing* option without the need for additional equipment (see section 3.6.6).

* (web version of Google Meet)

Optionally, a Windows PC-OPS module and/or Chromebox may be connected and used simultaneously for an all-in-one, multi-operating system solution.

Obviously, if you prefer working with your personal device, you may also do so by connecting it to one of the multiple ports or via the new USB-C* port (Thunderbolt 3 cable included) or EsharePRO mirroring function, capable of connecting wirelessly from a mobile device with a resolution of up to 4K (see section 3.4.9).

* Device must support the Thunderbolt 3 specification

In addition to a detailed description of all display features, this manual also contains videos which will help you understand the processes.

To get started, click on the following link to watch a video overview of everything this display can do.

[PLAY VIDEO](#)

2.1-. Included accessories

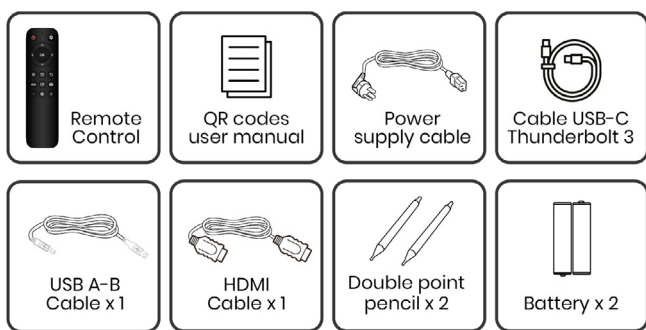

2.1.1-. Wall Mount

For proper ventilation, leave at least the amount of space specified in the following image around the display during installation.

Technical drawings of the equipment are available in section 4.2.

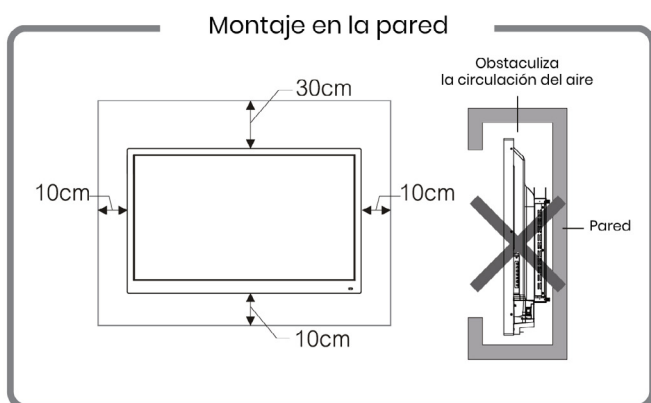

2.1.2-. Remote control

[PLAY VIDEO](#)

1-. Power (off / on): Quick press - sleep: If you press longer than 1 second, a confirmation message will appear. If this message is not cancelled, the display will shut down completely after 10 seconds.

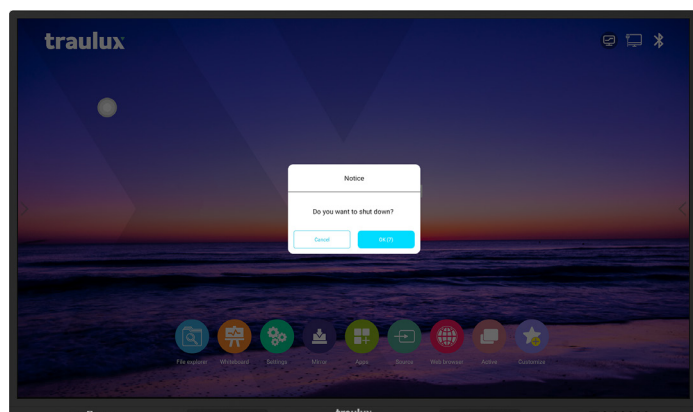

2-. Source:

Shows all available input sources

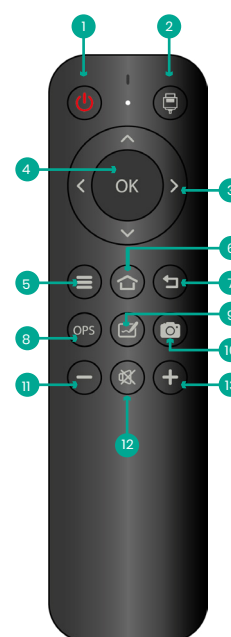

3-. Arrows: These arrows have a different function depending on where we are. Examples include:

Changing between images from the same folder, scrolling through the cells of an Excel worksheet, turning the page in a PowerPoint presentation, scrolling through a PDF or Word document.

4-. Confirm operation

5-. Main menu

6-. Home: Takes us to the homepage

7-. Back

8-. Shortcut to the PC-OPS module

9-. Shortcut to the whiteboard

10-. Screenshot

11-. Vol -

12-. Mute

13-. Vol +

2.2. Connections and controls

Frontal

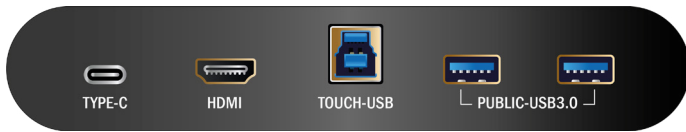

Base

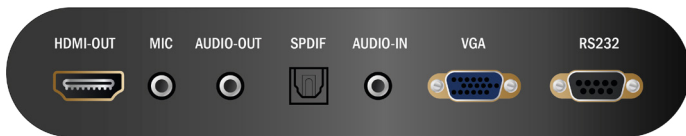

Side



1-. USB A 2.0 and 3.0 Ports

The USB-A 2.0 and 3.0 ports are used to connect external memory devices to the Android system. The files may be easily read with the File Explorer (see section 3.4.5).

The maximum current is 500 mA for the USB-A 2.0 port and 900 mA for the USB-A 3.0 port.

These ports are also used to connect compatible external devices such as microphones, webcams, VC soundbars, keyboards, etc. (see section 3.4.8 Network and Connections).

Bear in mind that, if using a wireless keyboard, the USB receiver must be visible to the transmitter. The best option in this case is a front port or side port + USB extension cable.

USB 3.0 – Auto PC-OPS and Android Switching

These ports operate with both systems, Android and PC-OPS. The display will automatically switch between them depending on which source is selected.

2-. USB B Touch Ports

When a USB-B Touch port is connected to the same device as the input source, the device may be controlled from the interactive display.

3-. USB-C port

This port transmits video, audio and touch input and supports charging up to 60 watts.

To ensure correct operation, use a ThunderBolt 3 cable (like the one supplied). Make sure that the device also supports the Thunderbolt 3 specification.

4-. HDMI-IN

The maximum supported resolution is 4K 60 Hz.

5-. VGA + Audio In

6-. HDMI-OUT

This output port replicates the same signal shown on the display.

7-. SPDIF digital audio output

8-. MIC port:

Analogue microphone input. The microphone must be dynamic; always it will sound through the monitor's speakers (independent of the projection).

9-. AUDIO-OUT

Audio output.

10-. LAN ports

These LAN ports operate with both Android and PC-OPS (if the module is installed). The first of the two ports connected acts as input and the second as output.

11-. RS232 port

RS-232 series control port. (see the RS-232 codes in section 4.3)

Front buttons

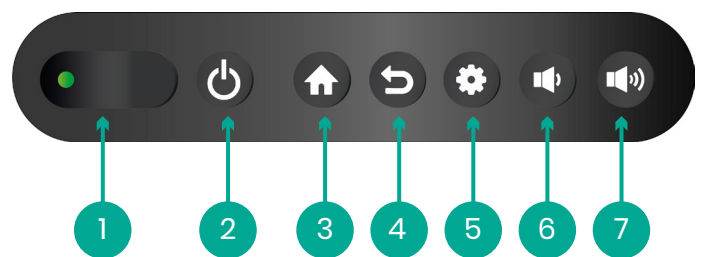

1. Remote control reception indicator

2. Power On / Off

3. Home

4. Back

5. Settings

6-7. Volume

HARDWARE

2.3-. Optional Modules

2.3.1-. Windows PC-OPS

Windows OPS modules insert into the side slot and function like any other computer with Windows 11 PRO (software installed and activated).

Inserting them into the display makes installation and use easier.



Ask the distributor about the available options.

- **PC-OPS – Power On/Off**

The PC-OPS will automatically power on when selected as an input source.

If the PC-OPS is turned on when you power off the display, it will shut down with the corresponding Windows command. You may also force the PC-OPS to power off outside the display (see section 3.3.3 Power off).

- **Working with a PC-OPS module and two interactive displays.**

[PLAY VIDEO](#)

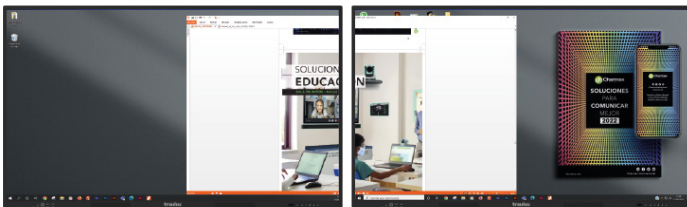

If you connect a second display to the HDMI port on the PC-OPS module, the graphics card will be configured as if working with a PC or laptop.

Right click the mouse (or long press the display) to deploy a menu with the option to:

- Extend
- Duplicate
- Show only on monitor 2

Here you may also establish the layout of the displays and set the main display.

If both are interactive displays, it will also be necessary to configure the touch input settings in extend mode, so that each screen interacts only with the image being displayed.

The procedure for configuring the touch input settings in extend mode is as follows:

- **It is necessary to connect a keyboard to the PC-OPS module.**
- **Click on the Microsoft icon to display the search engine.**

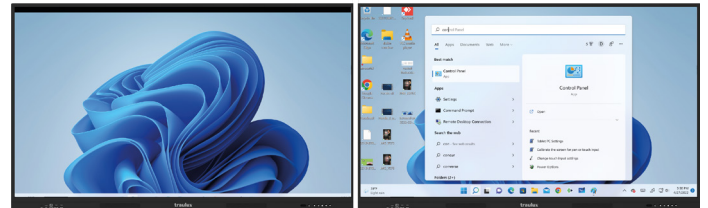

- **Search for Control Panel and click on the result.**

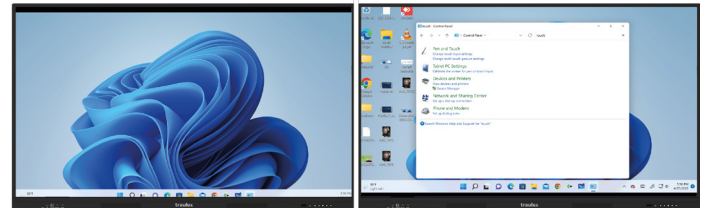

- **Find the touch input settings in the Control Panel and click on Tablet PC Settings.**

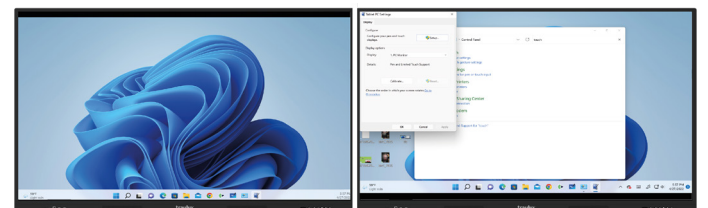

- **Click on Setup and Touch Input.**



- **Follow the on-screen instructions:** you will be asked to identify each display using your finger. To move from the first to the second and finally complete the process, press Enter on the keyboard.

2.3.2-. ChromeBox

Consult all available models.

The ChromeOS module is an external device that connects through the USB-C or HDMI + USB-B Touch ports.



This solution is 100% compatible with Google Workspace, enabling the use of all Google Apps and the management system, as well as access to PlayStore.

It is essentially a way of turning the display into a large touchscreen Chromebook.

The selected Chromebox references integrate perfectly with the display's interactive characteristics.

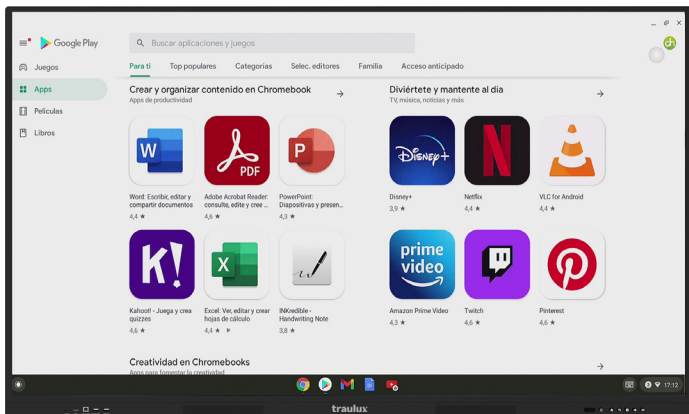

Settings

The first time you connect the Chromebox to the display, you will need a USB keyboard to enter your Google account e-mail address and password.

- **After entering your details, follow these two steps:**

1. Open accessibility

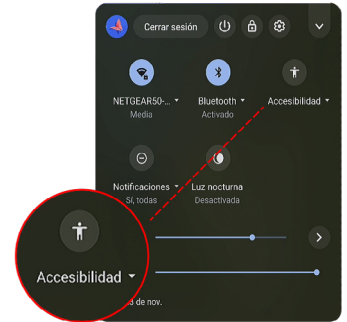

2. Enable touch keyboard in accessibility

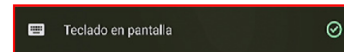
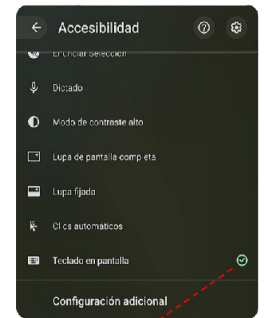

Adjust the size of the images for correct tactile access as follows: **Click on the configuration wheel**

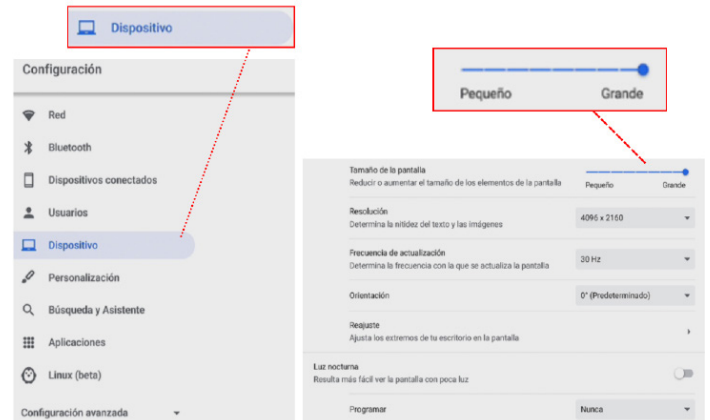
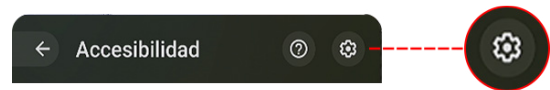



SOFTWARE ANDROID

The embedded processor with Android 9.0 OS, 8 Gb of RAM and 64 Gb of ROM, can meet most presentation or class needs without requiring external equipment.

The Android processor also allows you to hold videoconferences if you connect an external USB webcam or VC soundbar (web version of Google Meet, see section 3.6.6).

Information about GOOGLE Suite Apps

In accordance with Google policy, Google Mobile Services (GMS) are not preinstalled on TRAULUX displays, as certification programmes for interactive monitors do not exist.

As a result, some of Google's proprietary applications, such as PlayStore, Google Drive, Google Meet, YouTube, etc., may not be downloaded or used. However, there are web versions of some of these applications that offer limited options.

These limited options are often enough. For further information, see section 3.6.

For unlimited use of Google's proprietary applications, it is necessary to connect the optional certified Chromebox device that we recommended in section 2.3.2.

3.2-. Initial Startup

The first time you start up the display, the following messages will appear:

- **Select default language**

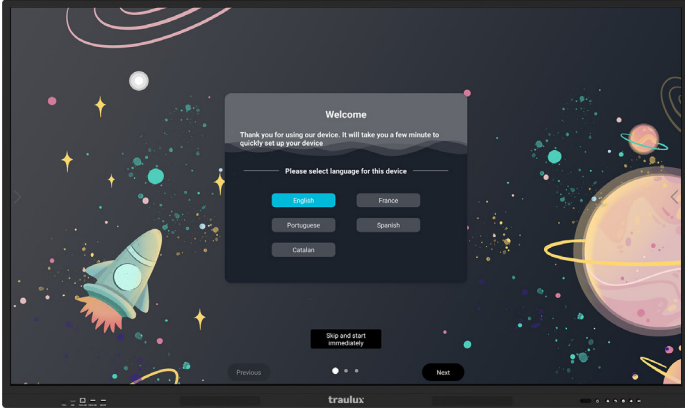

- **Date and time.**

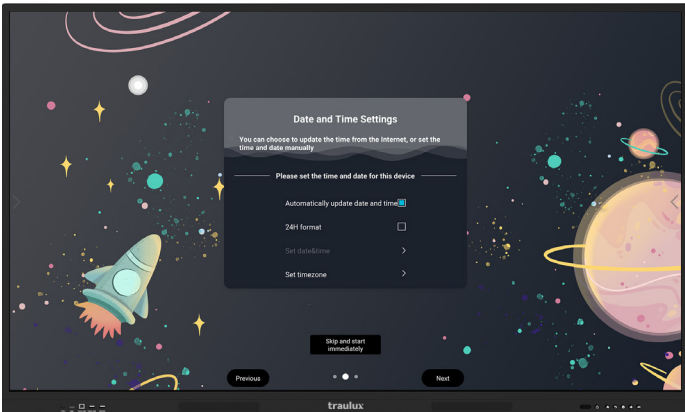

- **Network settings**

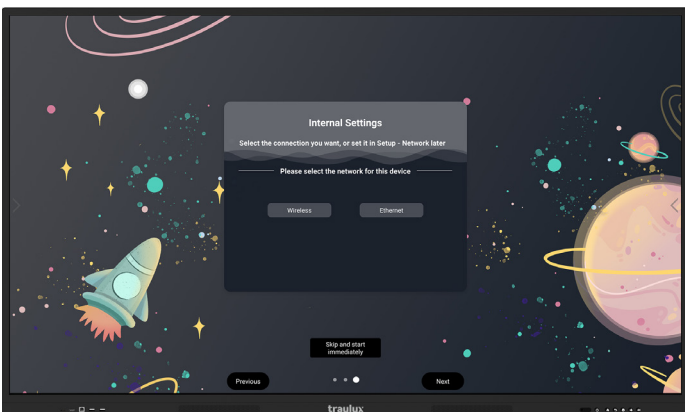

These settings may be changed later in the Settings Menu (section 3.4.8).

3.3-. Menu

3.3.1-. Floating icon

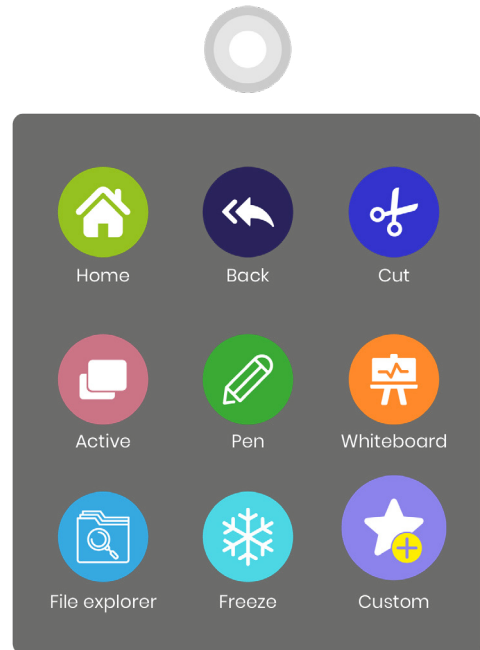

This menu appears when you click on the icon and hides once a function is selected or you click anywhere outside the menu.

By default, this icon is always visible, even over input from an external source. It may be disabled in Settings (see section 3.4.8 - Other).

It may be dragged anywhere on the display and pops up if we hold 2 fingers down for 3 seconds anywhere on the screen.



SOFTWARE ANDROID

The Floating Icon provides access to the most frequently used functions:

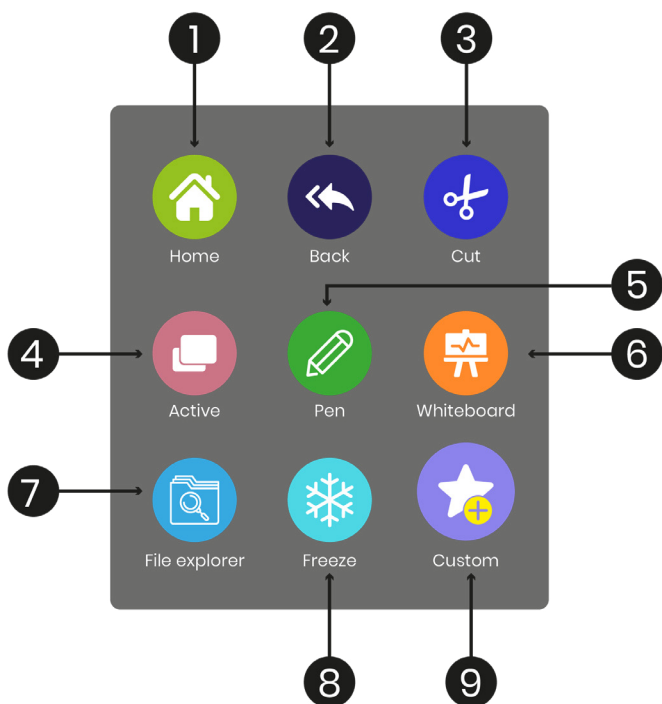

For further details about the features, see section 3.4

1. Home: Shortcut to the Main Menu.

2. Back: Undoes the last action.

3. Cut: Captures or cuts part of the screen, then saves it or sends it to the Whiteboard. (see section 3.4.1)

4. Active: Shows the apps running in the background (see section 3.4.2)

5. Pen: Adds a note layer over any image or input source (see section 3.4.3)

6. Whiteboard: Opens the Whiteboard app (see section 3.4.4)

7. File Explorer: Opens the File Explorer (see section 3.4.5)

8. Freeze: Freezes / Unfreezes the screen (see section 3.4.6)

9. Custom: Allows you to add up to 3 shortcuts (see section 3.4.7)

3.3.2. HOME Menu (visible only from Homepage)

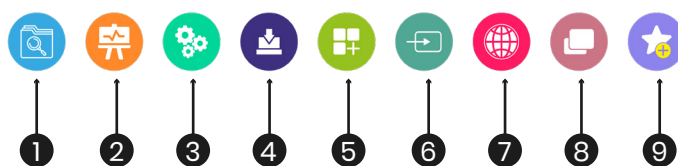

For further details about the features, see section 3.4

1. File Explorer: (See section 3.4.5)

2. Whiteboard: (see section 3.4.4)

3. Settings: (see section 3.4.8)

4. Mirror: Deploys the EsharePRO mirroring app (see section 3.4.9)

5. Apps: Apps explorer (see section 3.4.10)

6. Source: Select input source (see section 3.4.11)

7. Web browser

8. Active: Active apps (see section 3.4.2)

9. Customize: Allows you to add up to 6 shortcuts to your favourite apps (see section 3.4.7)

3.3.3-. Sidebar

This menu appears when you swipe inwards from both sides or click on this symbol:

The swipe gesture may be disabled in Settings (see section 3.4.8 Other)



Back: Undoes the last action.



Home: Shortcut to the Main Menu.



File explorer: Opens the file explorer (see section 3.4.5).



Source: Input source selection (see section 3.4.1).



Customize: Allows you to add up to 4 shortcuts to your favourite apps (see section 3.4.7).



Utilities: Utilities (see section 3.4.12)



Settings: (see section 3.4.8)



Pen: Adds a note layer over any image or input source (see section 3.4.3)



Active: Shows the apps running in the background (see section 3.4.2)



Shut down: Provides two shutdown options:

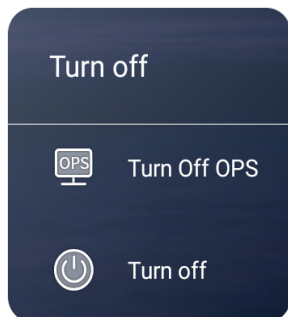

Turn Off OPS: Turn off only PC-OPS.

Turn Off: Turn off the display (AND PC-OPS if active).

3.4-. Features

[PLAY VIDEO](#)

3.4.1-. Cut (Trimming)

This function is accessible from the floating icon or from Utilities in the Sidebar.



When you click on Cut, a central box appears and the rest of the screen darkens.

The Cut options are:

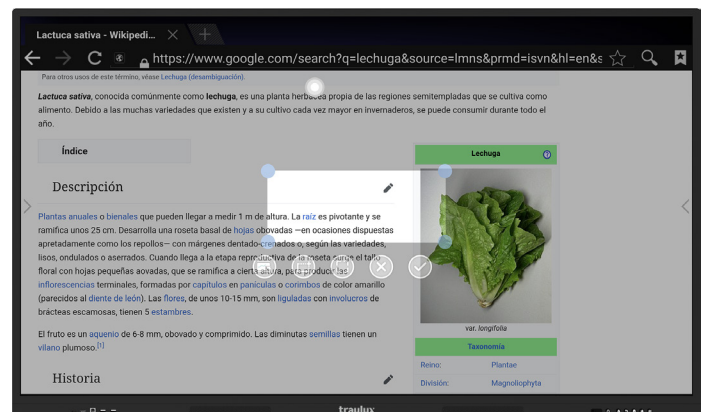

1. Rectangle Mode: Resize the box using the corners.

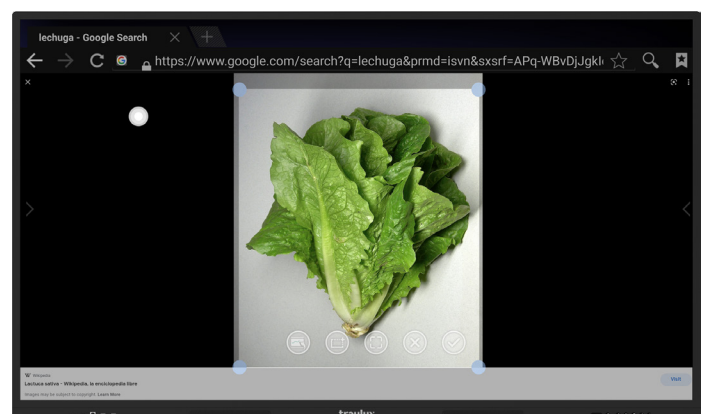

Rectangular crop

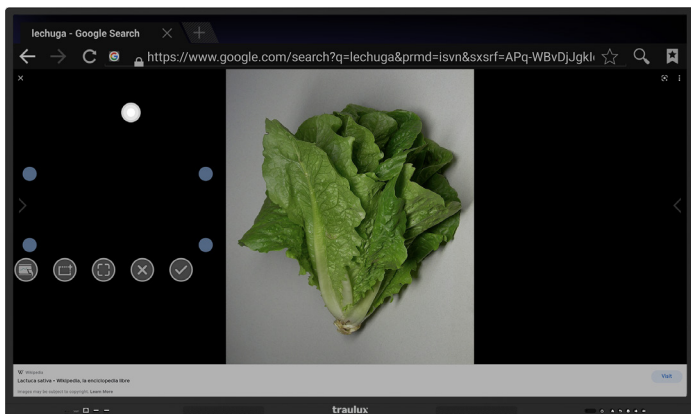
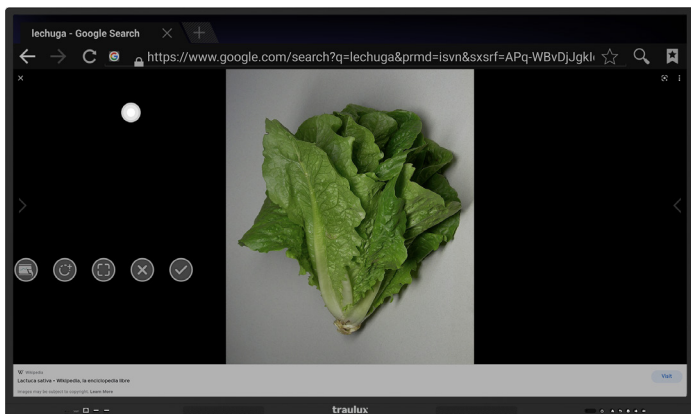

Once adjusted, the image may be sent directly to the Whiteboard by clicking on It will also be saved in the local folder "Pictures/Screenshots".

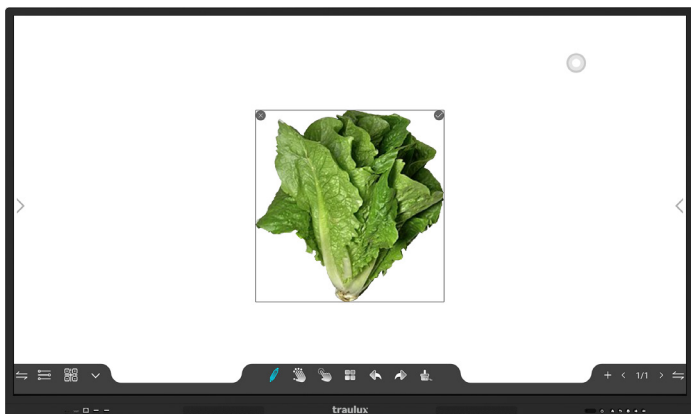

2-. Freehand mode: Select Freehand Mode by clicking on:

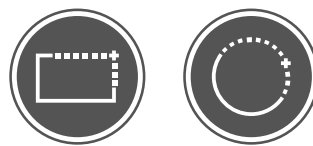

The rectangle will change into a circle, and the central box will disappear, turning the entire area grey.

Now you can select the area you want to capture freehand by moving the pen / your finger.

When you are finished, you can also send the image, which will be saved in the folder "Pictures/Screenshots", to the Whiteboard.

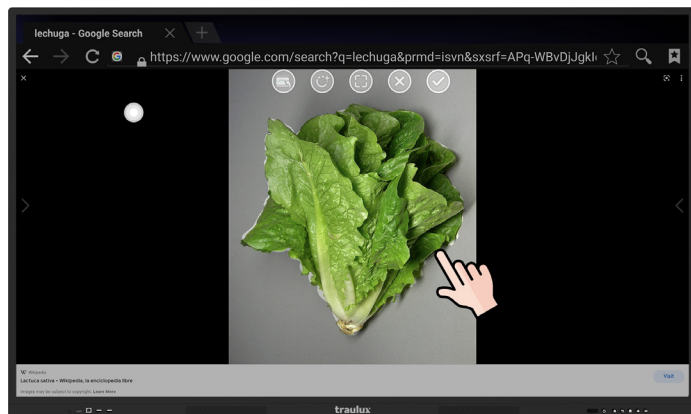

3. Screenshot: Click on to take a screenshot, send it to the Whiteboard and save it.



Click on the X to exit.



Click on to save the image in the local folder "Pictures/Screenshots" without sending it to the Whiteboard.

3.4.2- . Active and split mode.



The “active” function is available from:

- Floating Icon
- Home Menu
- Side Menu

The “Active” function shows us all the applications open in the background.

By clicking on the thumbnail of the corresponding app we can enter it, or click on the X to close it.

We can also close them all at once by clicking on “Clear all”.



Split mode

In Split Mode, you can use two apps at the same time, e.g. browse the Internet and read a PowerPoint presentation.

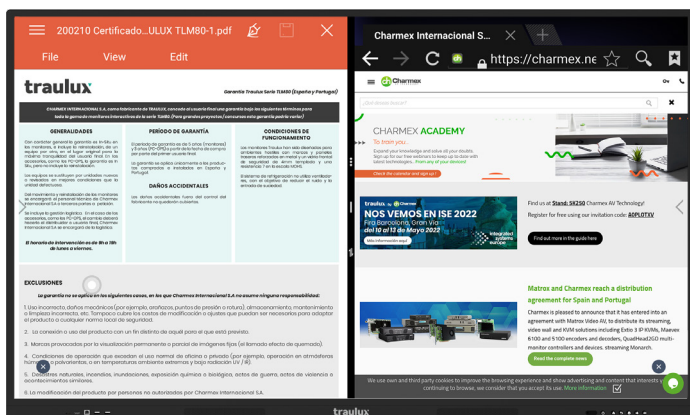

* Not all apps are compatible with Split Mode; only those with the corresponding symbol can operate in this mode.



Invert apps: This button allows us to invert the order of the apps.

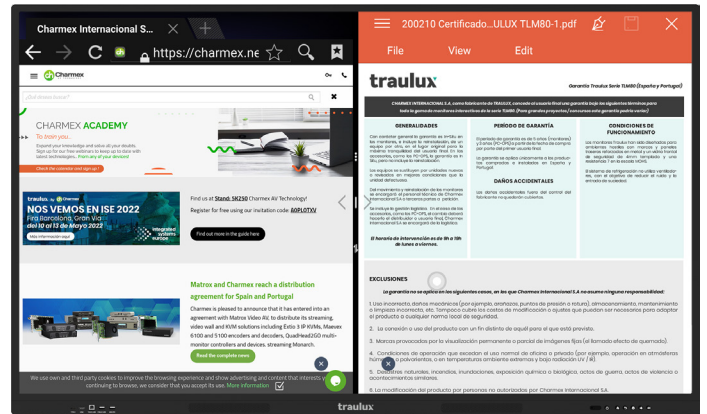

Drag the dividing line to one side to change each app's preview size. If you continue dragging towards the side, one app will turn into a thumbnail.

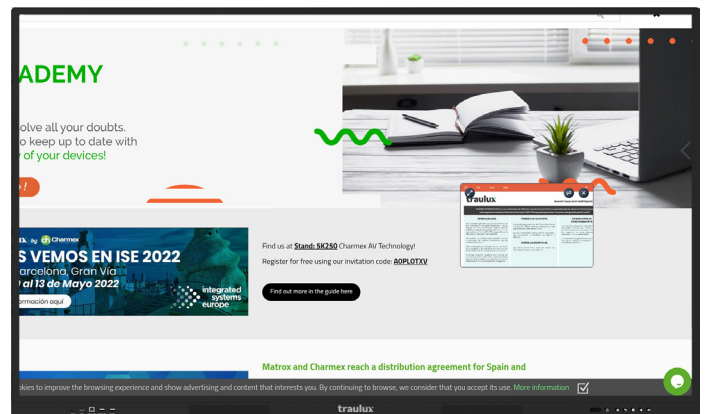

- The three dots are used to change the second app or select an external source. The external source will be displayed in one half, in PIP mode.

SOFTWARE ANDROID



3.4.3-. Pen – Note Layer.



The “pen” function is available from:

- Floating Icon
- Side Menu

Selecting the pen adds a transparent layer over any displayed image, whether it is from the Android processor, an external input or mirrored (Eshare PRO).

The note layer menu allows us to capture the image with or without notes and to create QR code to share it*

The QR code may be encrypted so that only those with the code may download the image onto their mobile device.

**Since the QR code is uploaded to a cloud server, it is not necessary to be connected to the same network to capture the image with your mobile device. This feature is ideal for sharing classes with remote students. To correctly read the code at a distance, it may be necessary to move the camera closer or use the display’s zoom option. The display must be connected to the Internet.*

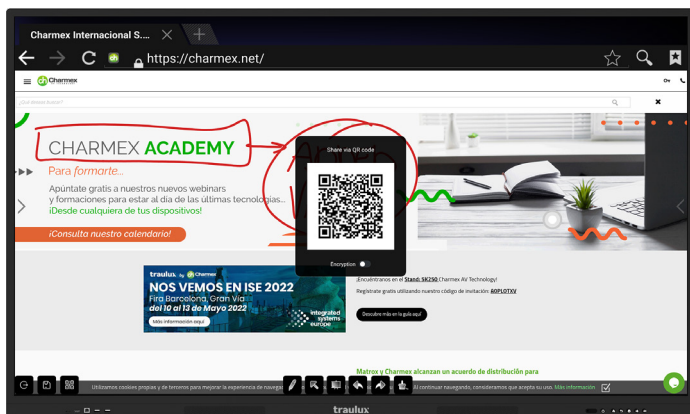
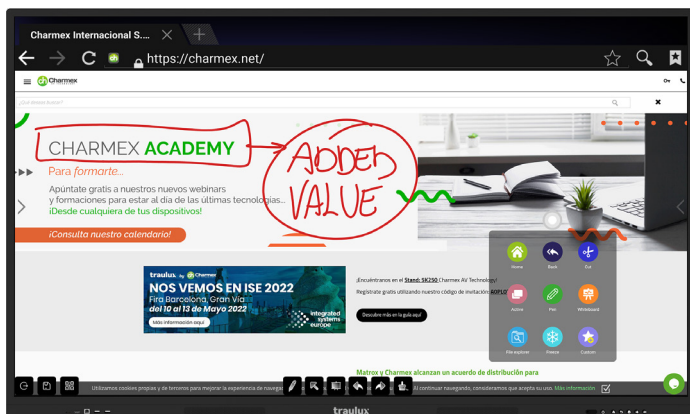

3.4.4-. Whiteboard (S-Write app)



The whiteboard application (S-Write) is accessible from:

- Floating Icon
- Main Menu

Board Menu:

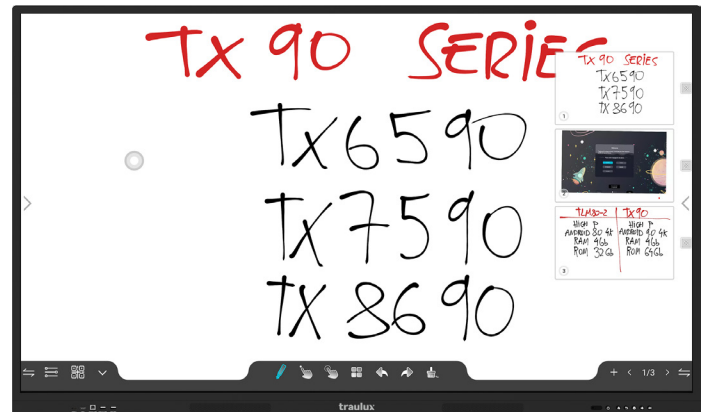

Exchanger: Switches the Sidebar from one side to the other.

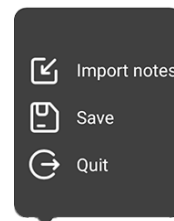

Import Notes: Imports classes created with the S-Write app in .iwb format (editable).

Save: Opens the save classes options; by default, classes are saved in .iwb format, editable with the S-Write app.

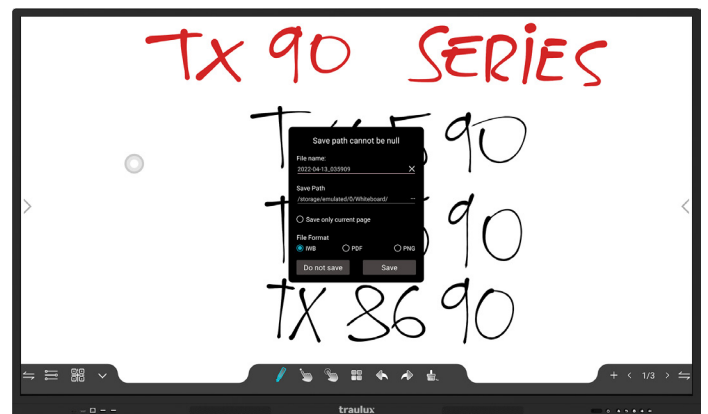

SOFTWARE ANDROID



QR Code Generator: Share all the pages of the class, or only the current one as selected.

In addition, we can encrypt it with a code to be requested at the time of download.



Hide: Hides the menu to see the full page:

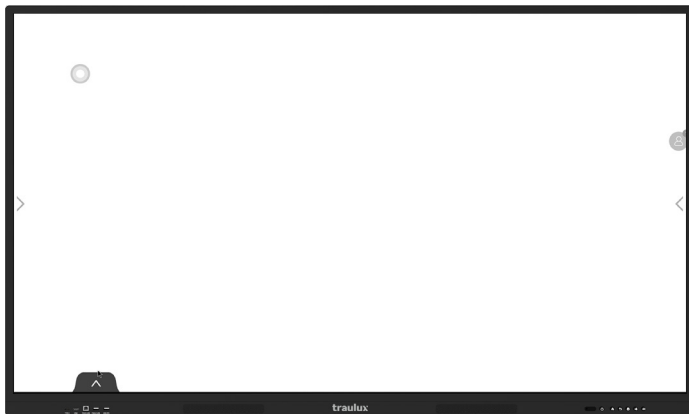

Pen: Select colour, thickness and type of pen.

You can choose a different colour and thickness for each tip:

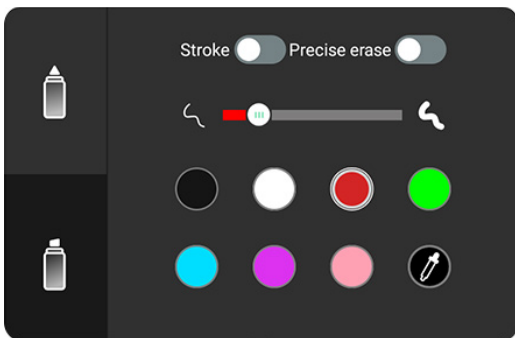

Your finger will act as a highlighter.

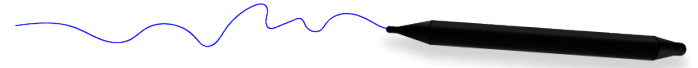

You can erase with the palm of your hand or any similar-sized object, e.g. a whiteboard eraser.

You can also select a more precise eraser from the thicker tip menu:

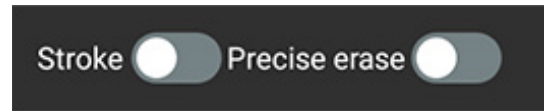

Another way to erase is by selecting an image or note and tapping X.

To delete the entire screen, see the Clear Screen option further ahead.

Multi writing: Click on this button to switch between one touch and multi-touch. The mode will change each time you click on the button.

One touch

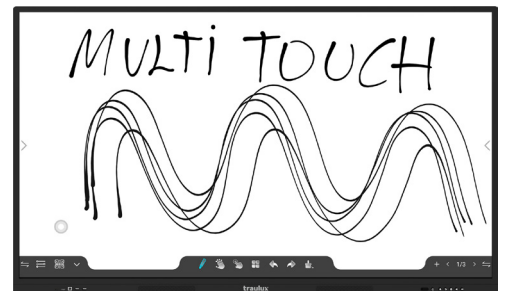

SOFTWARE ANDROID

Select: Selects objects or notes to move, resize or duplicate.

Select

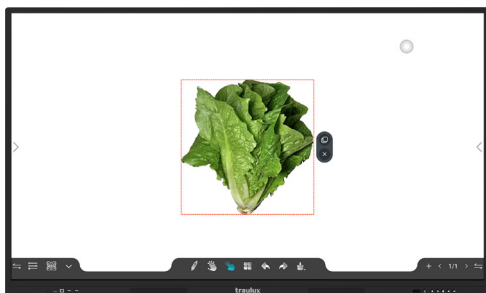

The following button provides access to several additional Whiteboard features:

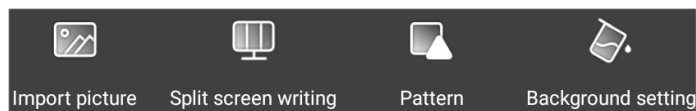

Import picture: This option shows the File Explorer, filtered for images. The selected image will be imported.

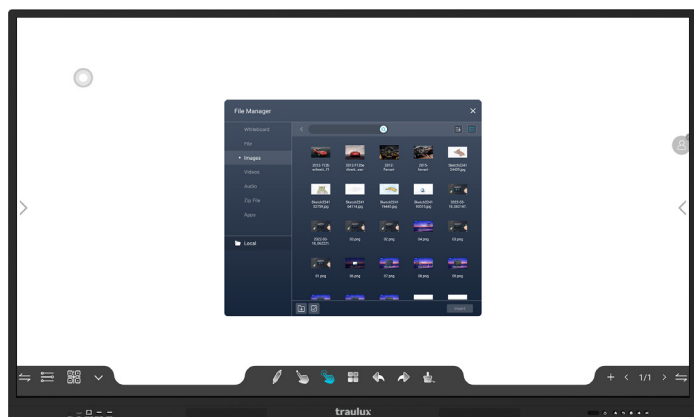

Split screen: The Split Screen option creates 2 or 3 independent workspaces and allows for simultaneous writing and erasing on different spaces.

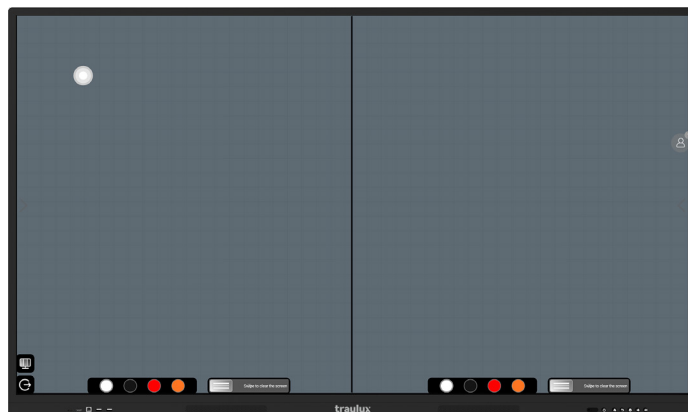

Preset shapes: Access to 6 preset shapes.



Background Setting: Choose between various colours or templates.

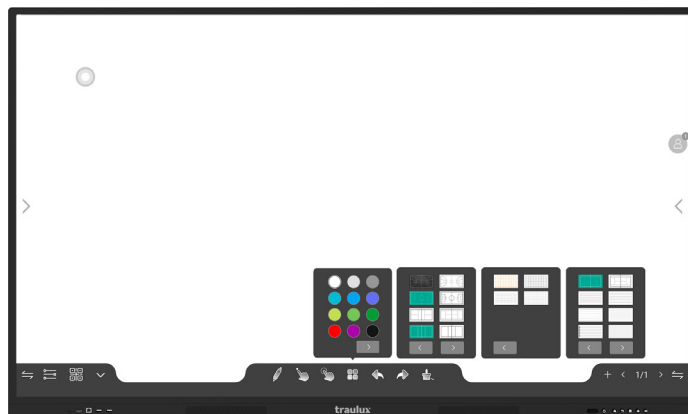

SOFTWARE ANDROID

Page eraser: Erases the entire page by sliding the button.

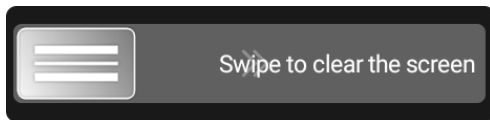

Page menu: Here you can add blank pages after the last page, move forward or go back a page or view them all as thumbnails, to find the page you want faster or delete it.

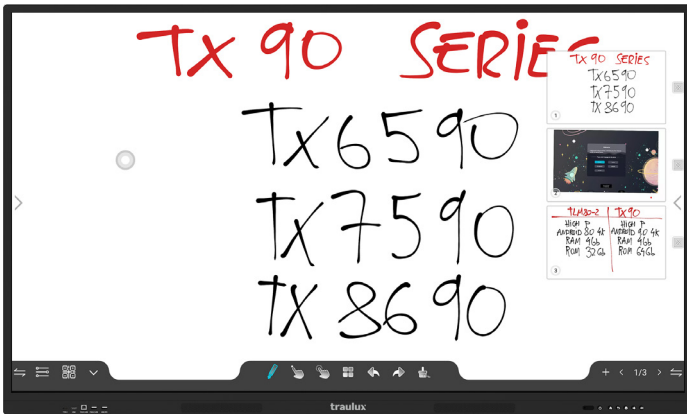

By clicking on a folder or file for more than 2 seconds, it will be selected giving access to one of the following actions:



- Copy
- Paste
- Cut
- Delete
- Send to another folder
- Rename



When using a USB memory device, click on this button to eject it.

3.4.6-. Freeze



Freeze is accessible only from the floating icon:

When clicked, the screen freezes.

It is useful to provide the audience something to look at while you prepare the next slide on your PC.

To unfreeze the screen, slide the button that appears at the top.

3.4.5-. File Explorer



The file explorer is accessible from:

- The floating icon
- Home menu
- Side menu

It will also open automatically when you insert an external USB memory device.

In the File Explorer, we can see the folder structure from the root up or filter by file type.



Slide to defrost

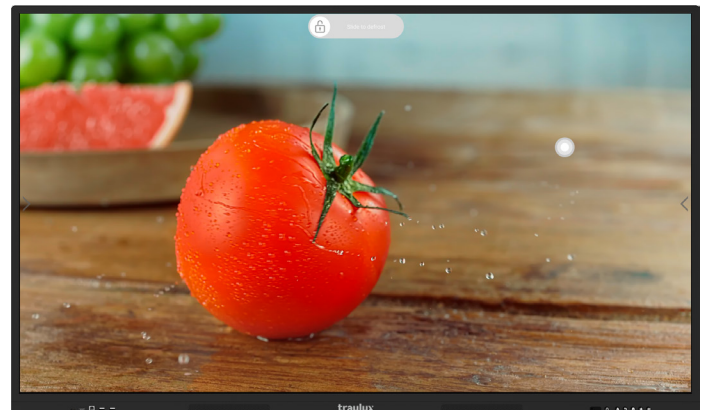

SOFTWARE ANDROID

3.4.7-. Shortcuts



The shortcuts are accessible from:

- Floating icon (3 accesses)
- Main menu (6 accesses)
- Side menu (4 accesses)

When we click on one of the add symbols, a list of all installed apps from which we may select a shortcut will appear.

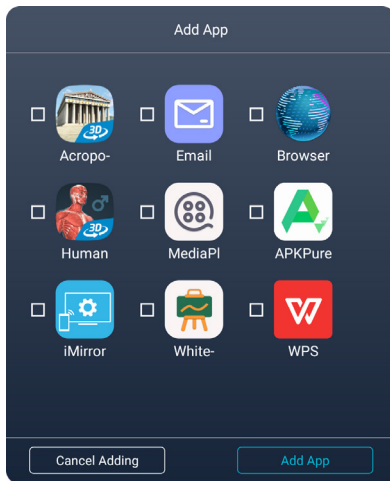

If we click on a created shortcut and hold for longer than 2 seconds, several options will appear:

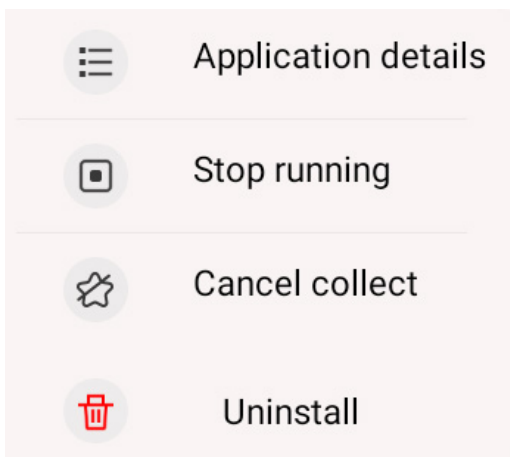

3.4.8-. Settings



Settings can be accessed from:

- Main menu
- Side Menu

Network and Connection

WiFi: We can add a hidden network or set up one of the available ones by clicking on it.



Ethernet: Choose between a static IP or automatic DHCP and configure the proxy if necessary.



Bluetooth: Link external devices such as keyboards, mouse, loudspeakers, etc...

Analog audio output: Here you can adjust the default volume for the analogue audio output



Audio input: Here you can see and select any connected USB microphone or enable / disable the wired microphone option.

Hot Spot: The display can create a hotspot to share the Internet connection (provided by Ethernet or WiFi) with the students / audience or make the EsharePRO mirroring system more stable (see section 3.4.9).

The USB microphone will be used for:

- Record audio while using the Screen Recorder app (see section 3.4.12 Screen Recorder)
- Or during videoconferences (see section 3.6.6)
- The wired microphone will sound through the display's speakers or any external audio system connected to the display.

By default, the hotspot will have a frequency of 2.4G, although it may be changed to 5G to make transmission as fast as possible.



Wallpaper:

Select the wallpaper for the Homepage from:

- **The preloaded options**
- **Shuffling between preloaded wallpapers**
- **A personalised wallpaper:** Click on the add icon to deploy the File Explorer, filtered for images. To choose the desired image, click on it and hold for longer than 1 second. Then, add it to the list of available wallpapers.



Security Settings: Sets a password or pattern lock.



Date and Time: Sets the date and time, as well as time zone and format.



Language and Input Method: Choose the language and keyboard.



Power Settings: Access to the different power on and off settings:



Power-On Mode: Choose how you want the display to power on:

- **Power on upon connecting to power source.**
- **Standby upon connecting to power source.**
- **Apply settings from last power off.**

Screen Off and Standby: If the No Operation option is enabled, the display cannot be put in standby mode. Quickly pressing the power button will make the power off confirmation message appear.

However, if, as by default, this option is disabled, quickly pressing the power button will put the display in standby mode, while holding for longer than 1 second will make the power off confirmation message appear.

Timer for power On/Off : Option to schedule power on/off routines by days of the week and time.



You may set the display to automatically power on/off on certain days (the power switch must be turned on).

When powering off, a message with a 30-second countdown will appear, in the event you want to cancel the process.

Auto wake up upon source connection: The display will automatically power on when it senses a source connection (the power switch must be turned on).

Wake On Lan: The display will automatically power on when it senses a source connection (the power switch must be turned on).



About: Information about the display.



In addition to complete information about the display, this option also provides access to firmware updates.

SOFTWARE ANDROID

Others:

- **Remote Lock:** Disables the remote control.
- **Button Lock:** Disables all front buttons except the power button.
- **Float Bar:** Disables the Floating Icon.

When the icon is enabled, it will always be visible, even over a wired or mirrored external input.



Sidebar Gesture switch: Disables the gesture to display the sidebar.

3.4.9- . Mirroring

INTEGRATED WIRELESS MIRRORING SYSTEM FROM MOBILE DEVICES.

EsharePRO makes it possible to share the screen from up to 9 simultaneous devices, reverse the projection and send documents from mobile devices to the display.

Compatible with Windows, MAC OS, Linux, Chrome, iOS and Android.

In PC Windows and MAC OS, the device may be controlled from the display.

Up to 4K projections: EsharePRO, in combination with the TX90 series, may support a 4K resolution under the following circumstances:

- Displaying from a PC, in extend mode + only displaying on screen 2.
- Displaying 4 devices, each in Full HD.

3.4.9.1- Application on the monitor



EsharePRO is accessible from the main menu:

By clicking on the Mirror icon, the welcome menu will be displayed.

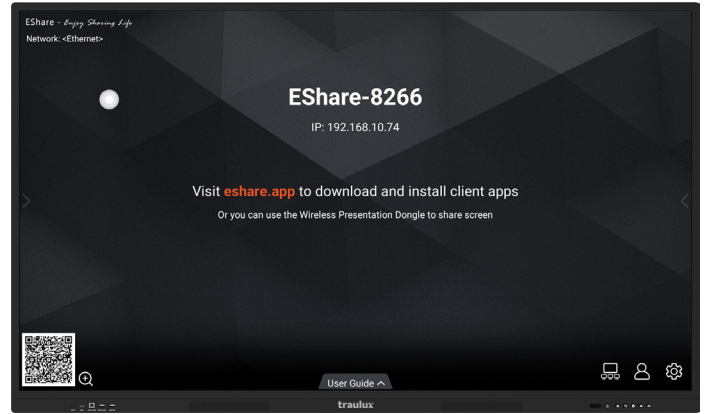

The User Guide tab features a guide with basic instructions.

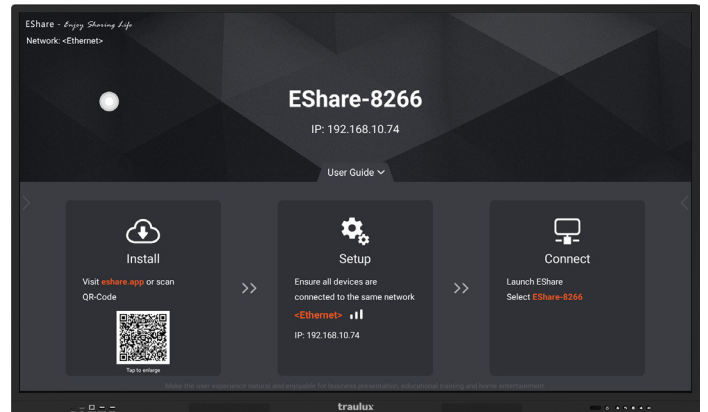

Settings

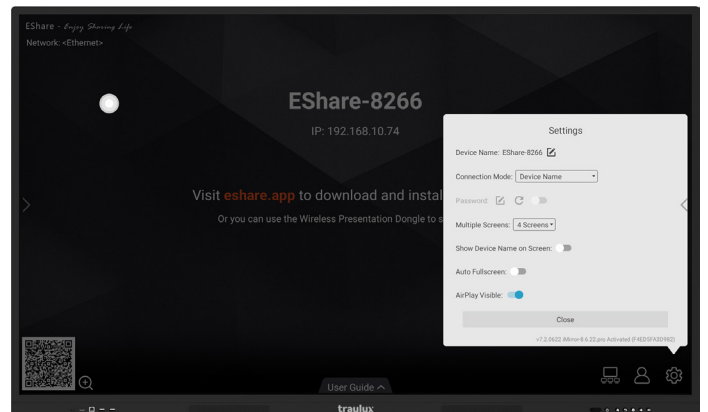

SOFTWARE ANDROID

Settings: In the “settings” section we can set:

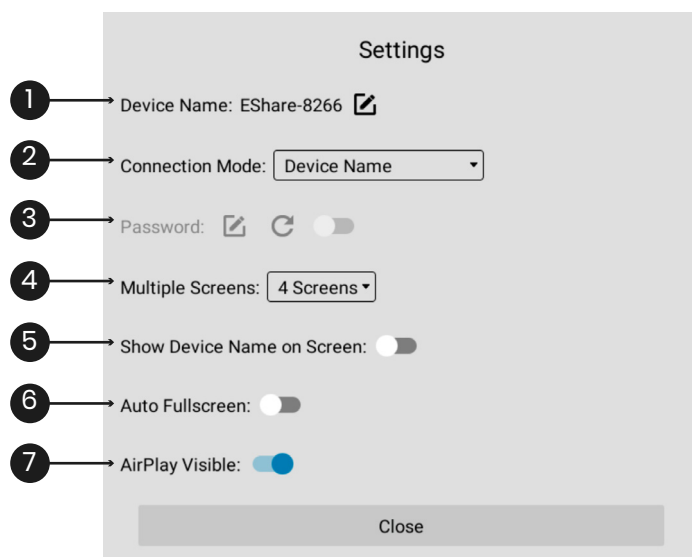

1. Device name: Name of the display that will appear on the devices

2. Connection mode: By default, the screen may be shared by simply clicking on the receiver name that appears on the device.

3. Password: Upon establishing a PIN code, we can create a password that will be requested on the mobile device before the screen is shared.

4. Multiple screens: Set the maximum simultaneous projections.

5. Use this switch to determine whether you want the code to be visible.

6. Auto Fullscreen: This option will put the display in full screen mode when the transmitting device’s format does not coincide with that of the display (this will distort the original image’s aspect ratio).

7. AirPlay Visible: Here we can disable / enable compatibility with Apple’s native AirPlay mirroring system.

Moderator Control Centre: With this menu, we can change the Moderator Mode settings:

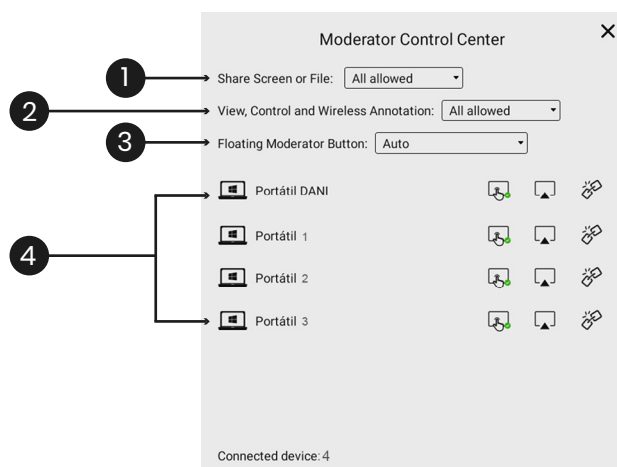
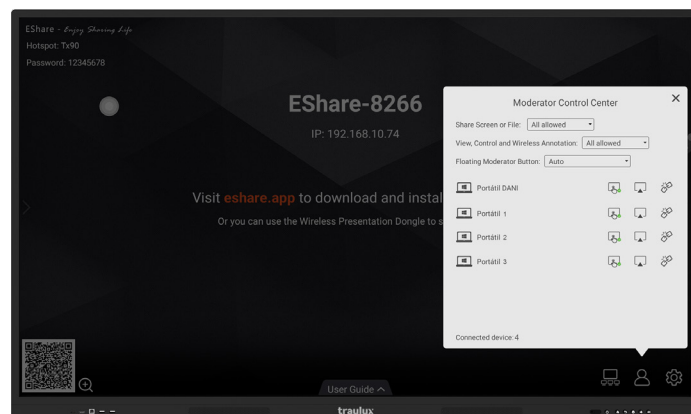

1. Share Screen or File: This option determines if the screen or files may be shared or whether authorisation from the moderator is required.

2. View, Control and Wireless Annotation: This refers to the reverse display mode, i.e. when the display is shared on the PC or mobile device.

This option determines whether the screen may only be viewed or also controlled, with authorisation from the moderator.

3. Floating Moderator Button: Enables or disables direct floating access to Moderator Mode.

The Moderator Mode shortcut may be configured so that it is always available, only on the Homepage or never.

4. You may select the devices you want to see from the device list in the Moderator Control Centre.

You can also unlink them or enable / disable remote control in the case of reverse sharing (TV Mirror).

SOFTWARE ANDROID

Projection to other TRAUlux interactive monitors (Display Group Settings)

This option shows a list of the Traulux interactive displays that are connected to the same network and range. The same image* will be duplicated on all selected displays.

*Touch input and sound will not be duplicated.

A confirmation message will appear on the receiving displays before the screen is shared.

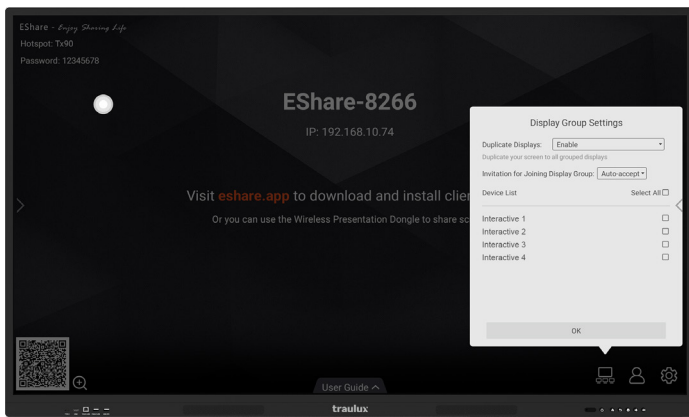

3.4.9.2-. Projection from devices

Download site: <https://eshare.app/#once>

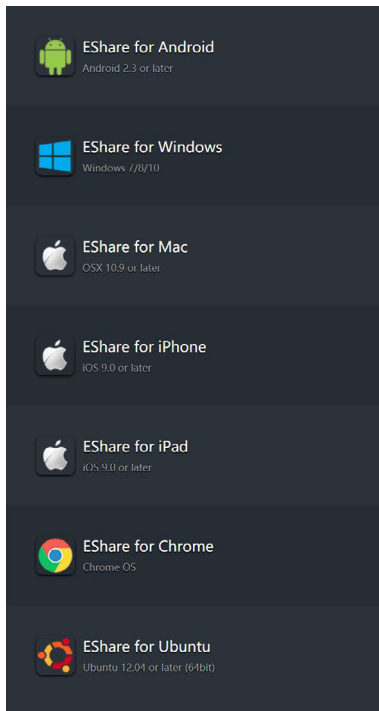

APPLE

When using an iOS device, there is no need to download any app to share the screen to the display. However, if you wish to access other functions, it will be necessary to install the EsharePRO app, in the manner indicated further ahead.

With the Windows and MAC operating systems, two touch points are transmitted (this function must be enabled in settings) (see section 3.4.9.1-.Application in the display – Moderator Control Centre)

Connection

To establish a connection between the mobile device and the display, one of the following conditions must be met:

- Display and mobile device connected to the same Wi-Fi network.
- Display connected to LAN and mobile device connected to Wi-Fi within the same range.
- Display connected to LAN and hotspot enabled (see section 3.4.8, Network and Connections). Mobile device connected to hotspot.
- PC-MAC OS computers may be connected to LAN. It will also work if the display is connected to LAN within the same range.

If a connection cannot be established despite meeting these conditions, it is possible that the Wi-Fi network does not comply with certain requirements. In this case, consult the distributor.

Mirroring from a PC

Download the app from: <https://eshare.app/#once>

- Choose the PC operating system.
- Connect the PC to the same WiFi Network or use LAN.

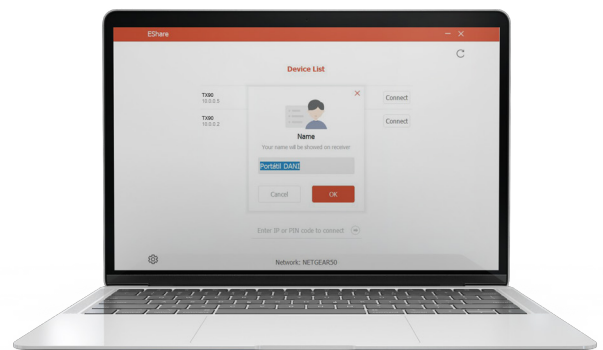

You may set the name of your device and the mode for accepting mirroring in Settings.

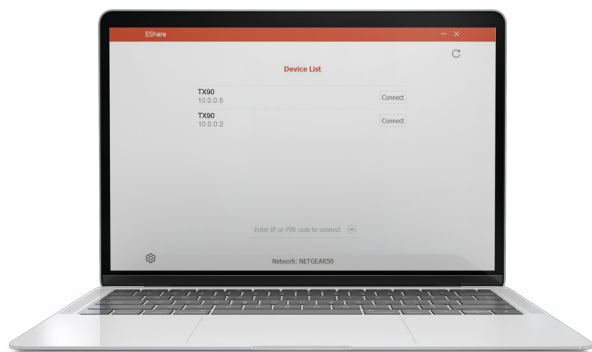

2. TV Mirror:



- **There are two mirroring modes:**

Screen Share (Full or Extended): The PC's screen will be duplicated or extended on the display, depending on the selected option. **Windows only.*

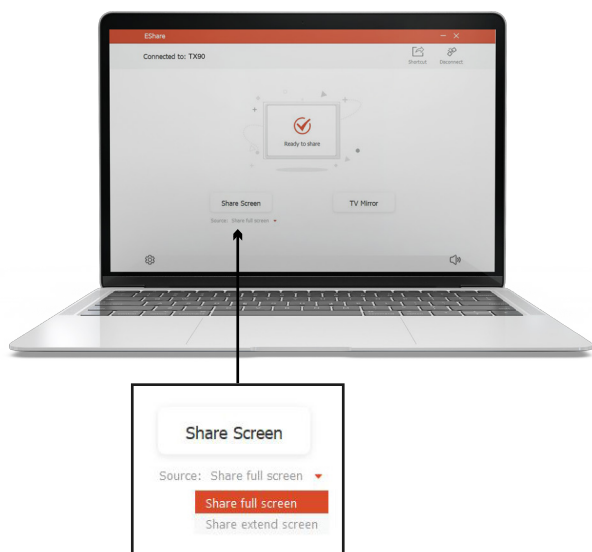

In Shortcuts, you can create a shortcut on the PC or laptop's desktop. To share the screen on the display, all you have to do is click on it.

- In Moderator Mode, permission will be requested.
- If the control option in the moderator menu is not disabled, the PC or laptop may be controlled from the display (2 touch points) in Share Full Screen mode.

In reverse mirroring mode, the image on the display may be viewed on the PC or laptop.

The display may be controlled from the PC provided that this option has not been disabled in Moderator Mode.

The side tools may be used to create a note layer from the PC. This layer will be visible on the display, although interaction will not be possible.

- In TV Mirror mode, the laptop's keyboard will not be operational. You must deploy the on-screen keyboard and click on the letters using the mouse or the laptop's touchscreen.

Mirroring from an Android Smartphone or Tablet

It is necessary to install the EsharePRO app if using an Android Smartphone / Tablet. Bear in mind that the Android system does not support the wireless transmission of sound in Full Mirroring mode (sharing the screen in real-time).

However, it does allow the transmission of sound in files sharing mode (to send, for instance, a video file to the display and play it).

Download the app from PlayStore or the EsharePRO website: <https://eshare.app/#once>

Once a connection has been established, a list of all available displays within the same network range will appear.

It is important that you give your display a logical name, to make easy to identify.

SOFTWARE ANDROID

List of available devices (Displays): Select the name of the display to which you wish to share the screen.

If the PIN code option is enabled, you must enter the code before mirroring. If Moderator Mode is enabled, you will not be able to share the screen unless the moderator gives permission from the display.

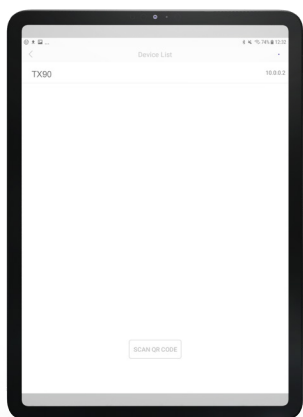

Welcome page: The Welcome Page shows the File Explorer for the device's internal storage.

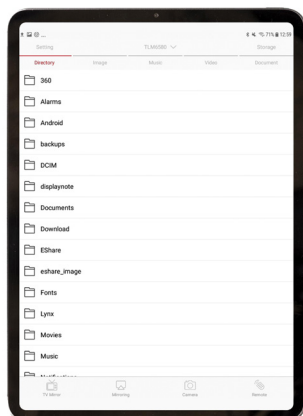

If we select a document that is compatible with the display's Android OS, it will be sent directly to the display and will be stored in its internal memory*.

We may play or control it from the display or from the remote control deployed in the mobile phone / tablet. If the document is an image, it may be controlled from the mobile phone or tablet.

**The files will be stored temporarily and will be deleted once the display is powered off.*

Remote control: Remote control deployed on the mobile / tablet.

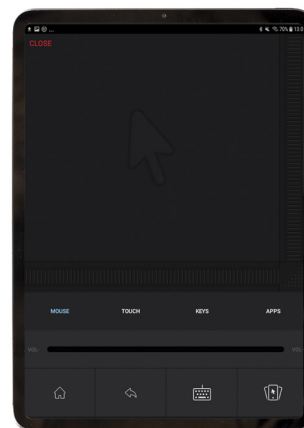

TV Mirror: This feature projects from the display to the mobile device. The display may be controlled from the device provided that this option has been enabled.

Mirror: This option shares the device's screen to the display* (bear in mind that Android does not send sound in this mode. To do so, you must send the file).

Camera: The image captured by our device will be shared on the display. The light bulb will turn on the device's torch for better visibility.

- If you have a dual camera, you may turn it around.
-
- The blue button will capture the image and send it to the display.



Projection from an iPhone or iPad (iOS)



APPLE Airplay

It is not necessary to install the Screen Mirroring app when using an iOS SmartPhone / iPad, as they are compatible with the native iOS system (AirPlay).

However, to access other additional features, it will be necessary to install the EsharePRO app.

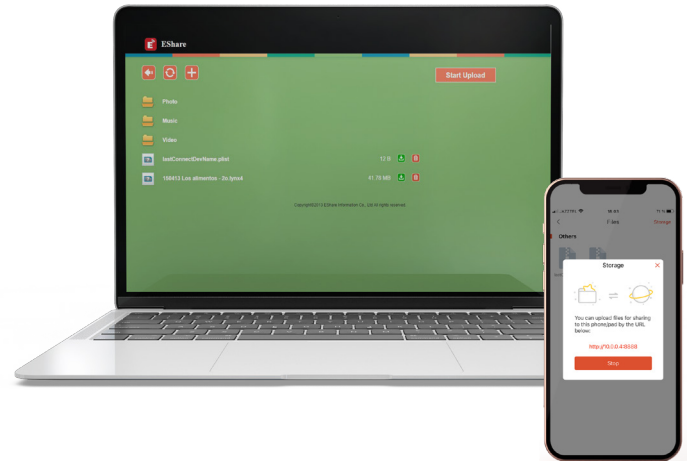

Download the application from the AppStore or from the EsharePRO website: <https://eshare.app/#once>

Once a connection has been established, a list of the available devices (displays) will appear. List of available devices.



iOS Welcome Page: The Welcome Page on iOS devices shows the same functions as in Android, but with some differences.

You can explore the files filtered for images in the internal storage (if clicked, they will be shared to and may be controlled from the iPhone / iPad), or videos and files (these will be sent to the display and saved in its internal storage, and may be controlled from both the iPhone / iPad and the display).

Here, the means of navigating between folders is different. iOS does not allow third-party access to the memory's internal structure.

EsharePRO will therefore create its own storage space for files on the device, which may be subsequently shared to the display. As a result, when you access Files, you will have a "Storage with an IP address" option, which will serve to send the files selected on the PC or laptop to the storage space designated by EsharePRO.

Full Mirroring from EsharePRO: Another difference occurs when mirroring.

iOS has its own mirroring system, AirPlay. As a result, when we select the Share Screen option, we will be asked to complete one last step: use the classic swipe gesture to show the hidden options, among them AirPlay / Screen Mirroring.

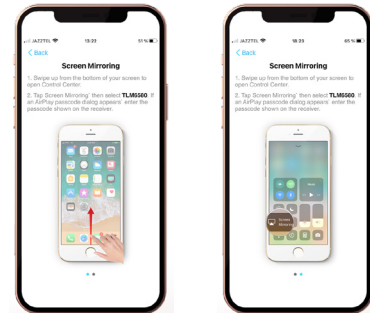

3.4.10-. App Explorer

[PLAY VIDEO](#)



The App Explorer is accessible from the main menu.



App Explorer

In addition to providing direct access to the apps, it also allows us to:

- **Uninstall:** Press and hold the app for one second, then drag it to the recycling bin that will appear in the upper left corner.



- **Regroup:** Swipe right to create a second page. Dragging one app on top of another will create a folder that will contain both apps and which you may name.

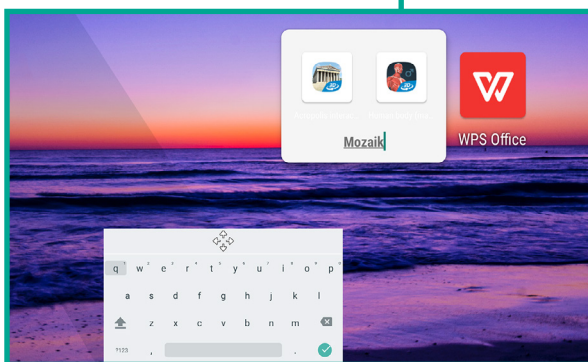
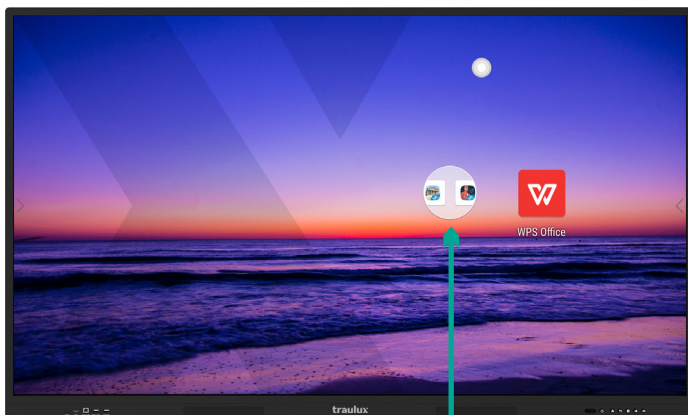

SOFTWARE ANDROID

3.4.11- Source



The input source selection is accessible from:

- Main menu
- Side menu
- Front button panel

The source preview enables fast selection.

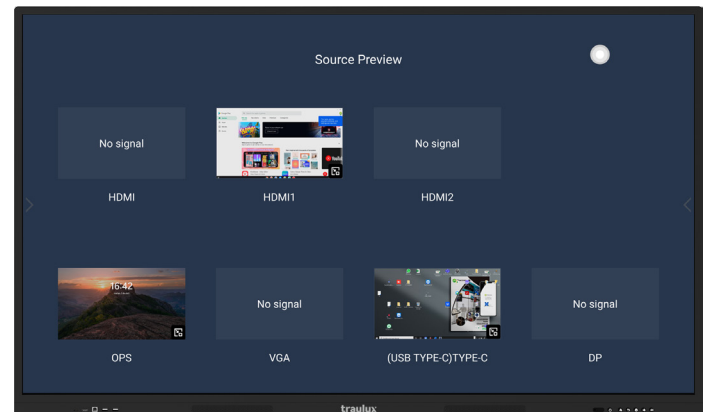

3.4.12- Utilities

[PLAY VIDEO](#)

In Utilities, you will find a series of tools that will help you to create dynamic and memorable presentations.



The Utilities are located in the Sidebar.

Countdown: Choose a day of the year and create a reminder counting down the remaining days. This reminder may be placed anywhere on the screen and will always be visible unless closed.



Eye Protection: Particularly at dusk, it is advisable to reduce the amount of blue light for more relaxed viewing. This feature provides several options: no filter / level 1 filter / level 2 filter.

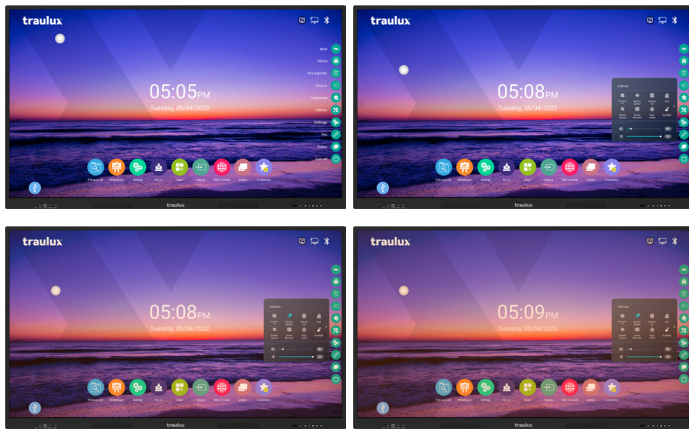

Calculator: The calculator will always stay on top of any app or input from any wired or mirrored (EsharePRO) external source.



Vote: With this app, you can send QR codes to mobile devices to conduct quick surveys.

Choose between the single or multiple valid answers options. Add the question and answers.



Generate a QR code so that participants simply have to scan the code on their mobile devices to respond.



Check the results.



Screen Capture: This option will take you to the Cut feature accessible from the Floating Icon. (see section 3.4.1)

Screen recorder: A tool that generates an mp4 video file, which may be played using the display, a Windows computer or any device that supports mp4 files.

To record audio, it is necessary to connect a USB* microphone (wired or wireless). A videoconference soundbar or webcam with a built-in microphone may also be used.

**Microphones connected to the analogue Mic In port will not work with this feature.*

When you connect the microphone, webcam or VC soundbar, a device recognition message will appear.

Upon launching the Screen Recorder, a message will ask if you want to enable the USB microphone or choose one if several are connected.



A small icon in the lower left corner will indicate that the screen is being recorded. It may also be used to stop the recording.



When the recording is stopped, the file will automatically be saved to the Movie/Recorder folder in mp4 format.

Stop watch: Stopwatch / timer



Spotlight: With this feature, you can use a circle to highlight the desired part of the presentation, darkening the rest.

A small cursor in the lower left corner will enable you to adjust the size of the circle.

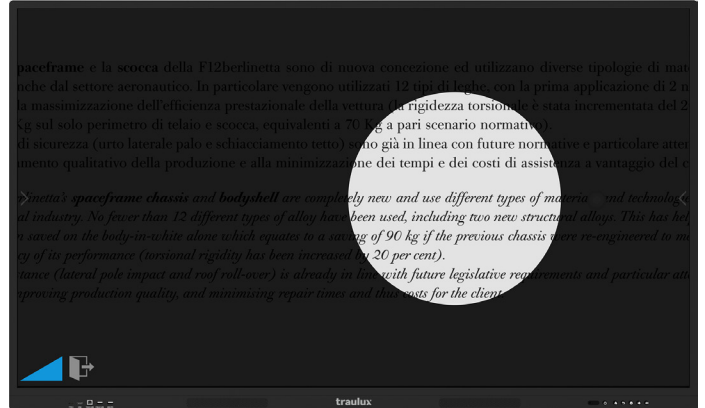

Touch Sound: Enable / disable the sound made when tapping.

Volume and Brightness Settings: Move the sliders to adjust volume and brightness.

Clicking (A) enables auto-brightness, which automatically adjusts the brightness to the level of light detected by the front light sensor.



3.5. Working with Office - PDF files

Thanks to its preinstalled WPS app, you can use the interactive display to read Word, PowerPoint, Excel and PDF files. In all cases, embedded notes may be added.

[PLAY VIDEO](#)

SOFTWARE ANDROID

Word - Power Point - Excel: Select Use Finger + type of pen + colour + thickness to add notes to the document. In this situation, you may move the document and notes by touching the document with two fingers.

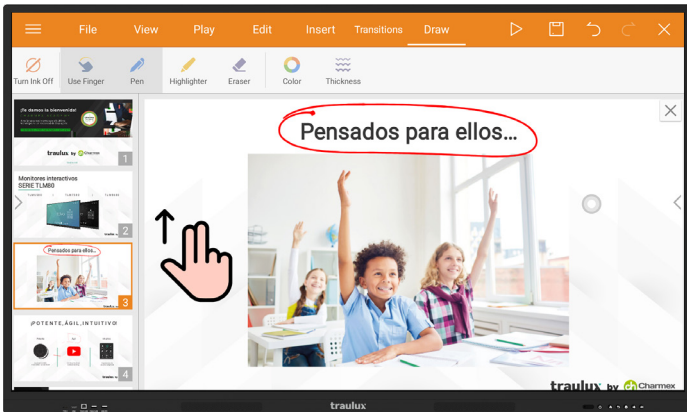
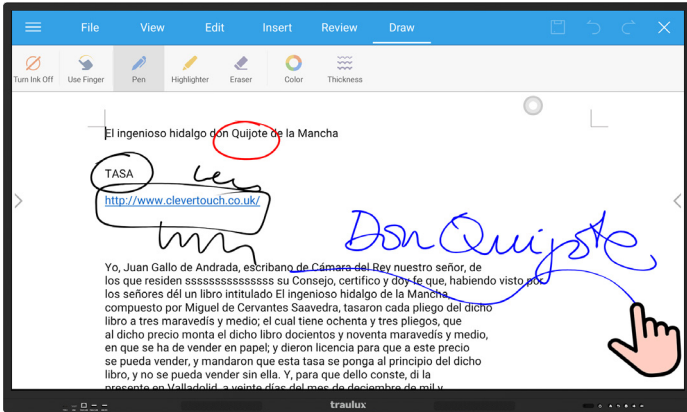

PDF: With PDF files, adding notes and scrolling through the document is slightly different.

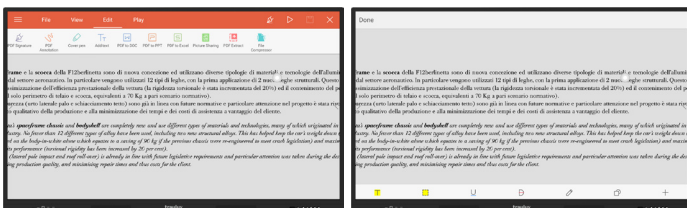

Afterwards, choose the type of pen, colour and thickness:

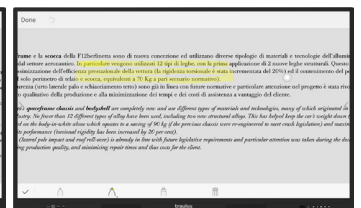
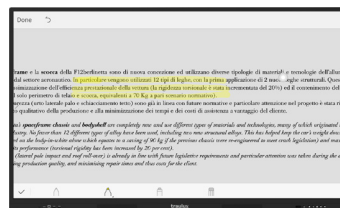
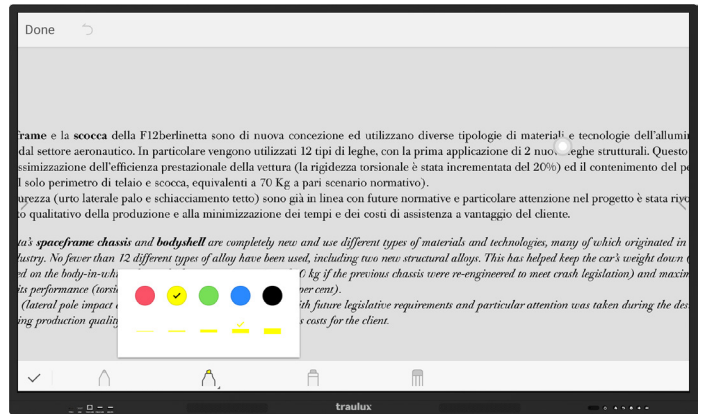

Click on to insert the note once completed*

*Inserted notes cannot be erased

Magnifying glass: Use the magnifying glass to zoom in on part of the text in a PDF document and make it easier to read.

To make the magnifying glass appear, simply swipe the desired text.



SOFTWARE ANDROID

3.6-. Working with Google Apps

Information about GOOGLE

In accordance with Google policy, Google Mobile Services (GMS) are not preinstalled on TRAUlux displays.

As a result, some of Google's proprietary applications, such as Google PlayStore, Google Drive, Google Meet, YouTube, etc., may not be downloaded or used.

However, there are web versions of some of these applications that offer limited options. These limited options are often enough. Further information will be provided in this section.

For unlimited use of Google's proprietary applications, it is necessary to connect the optional GMS-certified device that we recommended in section 2.3.2.

Chromium Web Browser: To increase the performance of the Google apps, we recommend that you use Chromium, the free version of Chrome, which you will find in Apps:

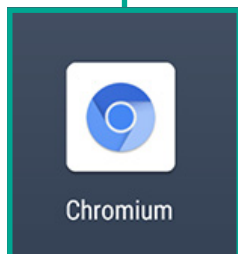

IMPORTANT: As we will explain in each of the following sections, the apps will only function if the browser is in Desktop Site mode.

To switch to Desktop Site mode, click on the three dots in the top right corner, then click on the option:

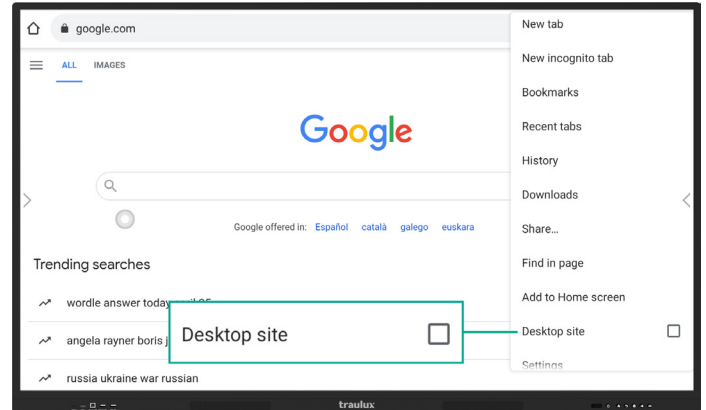

3.6.1-. Gmail

Click on Chromium, go to Google and switch to Desktop Site mode.

- Enter the word Gmail in the search box.
- Enter your login details. Choose the "Keep session open" option if you want this to be the Gmail account for all other Google Apps.

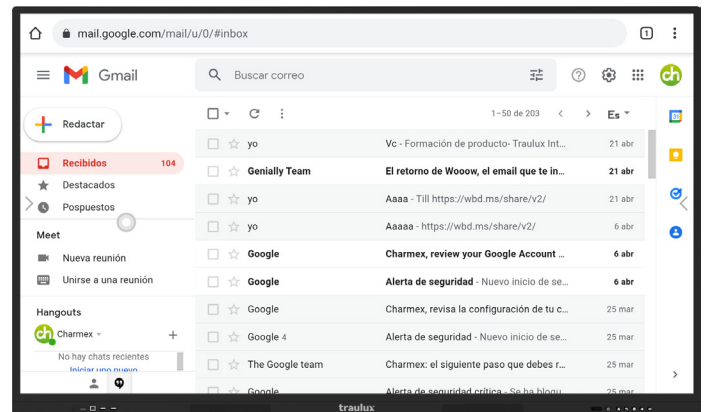

You can now write an e-mail as you would normally.

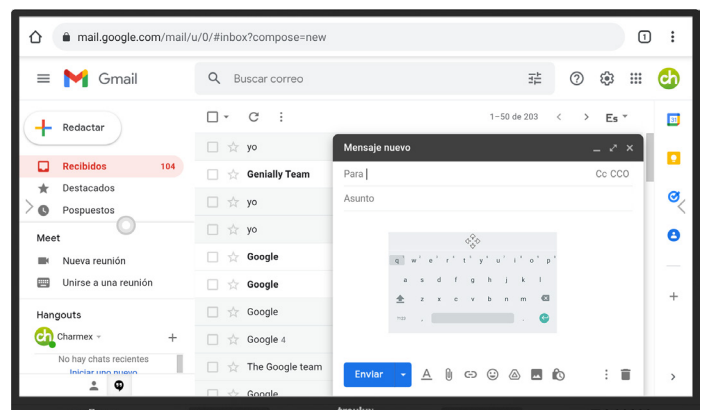

Attach files

Click on the clip symbol to open the File Explorer.

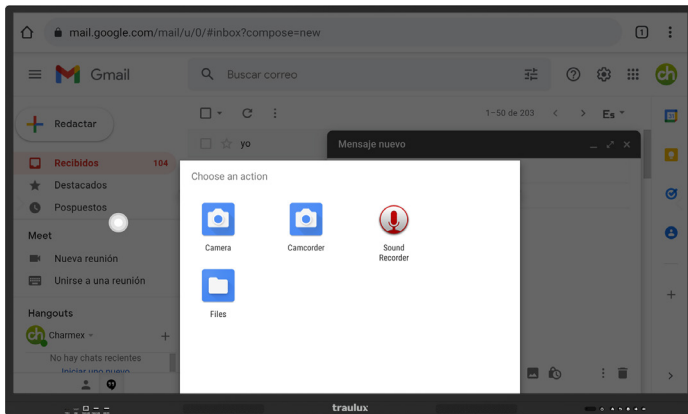

Select Phone

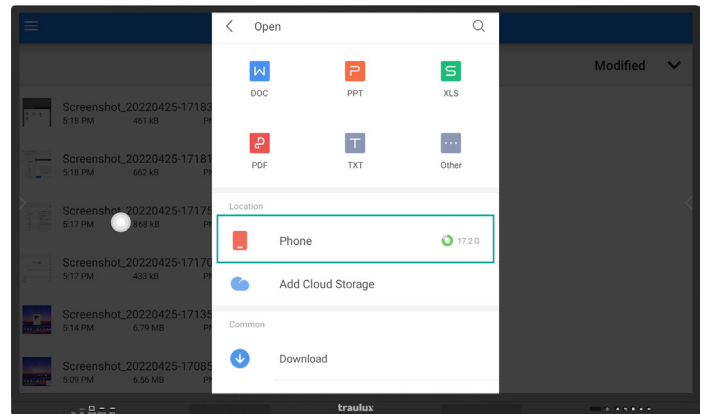

Select files : Click on the 3 lines to open the various explorer options.

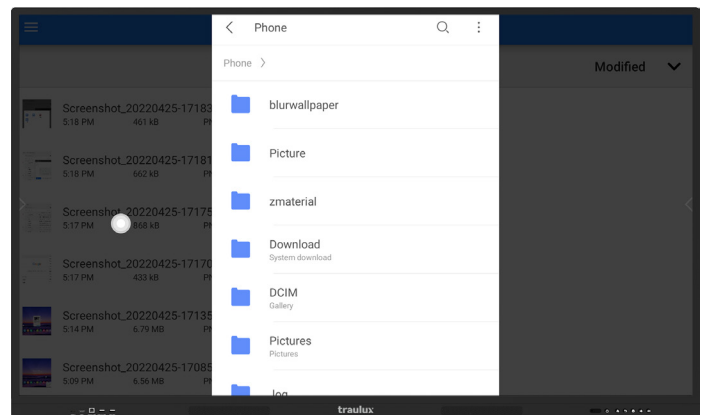
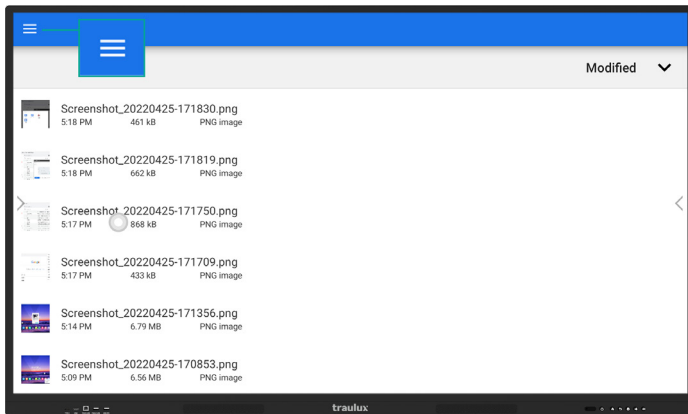

Here you can explore the display's internal storage and choose the file you want to attach.

Choose WPS Office as the explorer.

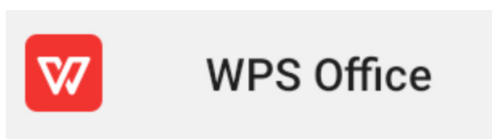

Select Open

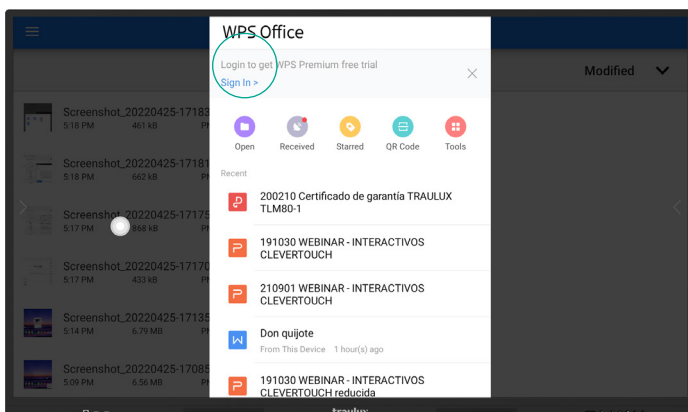

3.6.2-. Google Drive

Click on Chromium, open Google, switch to Desktop Site mode and write Google Drive in the search box.

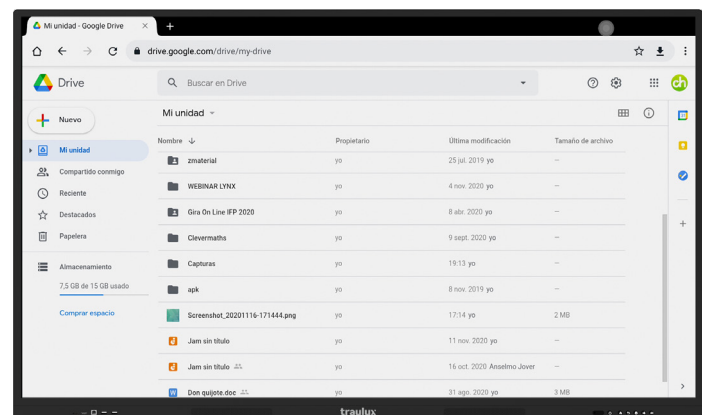

Upload files: Go to the folder where you want to upload the file and click New.

After this, the procedure is the same as the File Explorer procedure referred to in the section on Gmail.

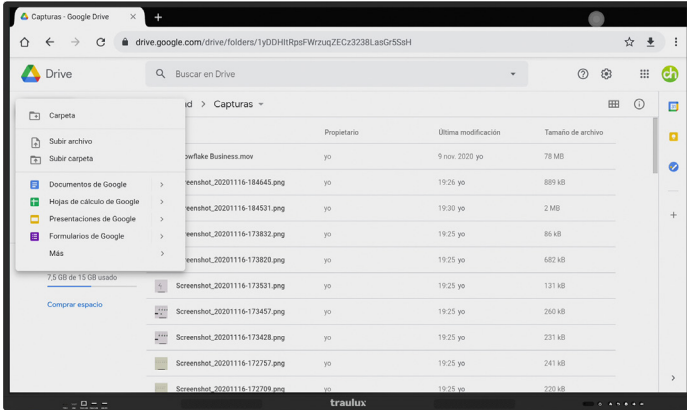

3.6.4- Google earth

Click on Chromium, open Google, switch to Desktop Site mode and write Google Earth in the search box.

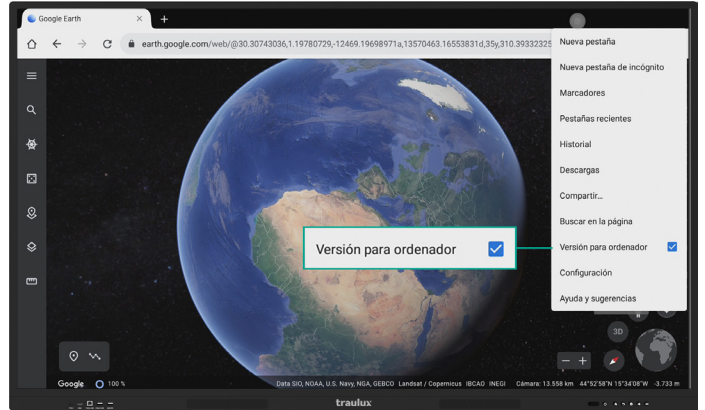

Open in Google Docs: Click on the file to open it in Google Docs (select compatible files: Word, Excel, PowerPoint, PDF...).

3.6.5- Google Jamboard

Click on Chromium, open Google, switch to Desktop Site mode and write Google Jamboard in the search box.

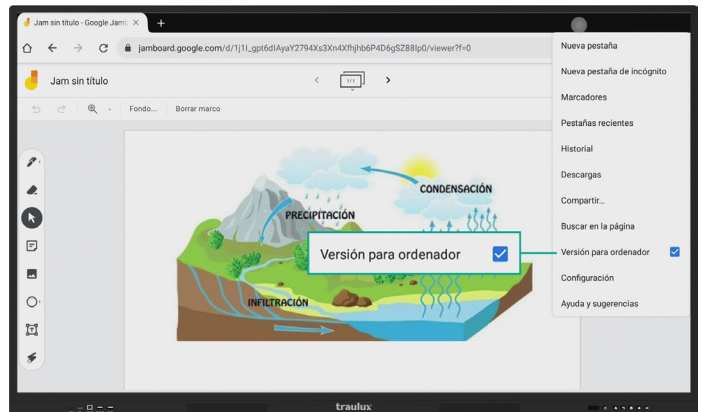

3.6.3- Google Classroom

Click on Chromium, open Google, switch to Desktop Site mode and write Google Classroom in the search box.

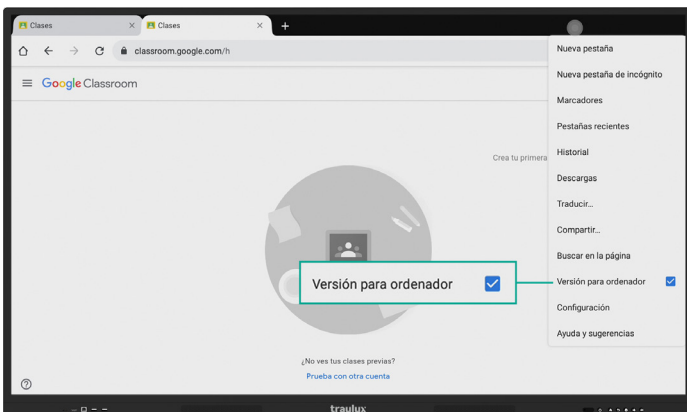

3.6.6-. Google Meet

Before opening Google Meet, it will be necessary to connect a USB webcam or VC soundbar compatible with Android.

To check that the camera is working properly, click on the USB Camera option in Settings (see section 3.4.8. Settings – Networks and Connections).

Click on Chromium, open Google and switch to Desktop Site mode.

Write Google Meet in the search box and click on the first link that appears in the search results.

Bear in mind that you will not be able to share the Android desktop, although you can make a call.

This is an example of the limitations we may encounter when working with Google Apps in the interactive display's Android OS. For full compatibility, a Chromebox will be necessary.

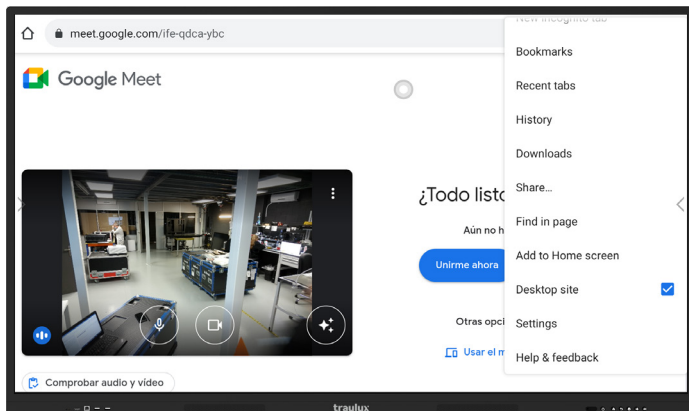

3.6.7-. Youtube

Click on Chromium, enter Google and switch to Desktop Site mode.

Search for YouTube in the Google Apps shortcut in the top right corner or write it in the Google search box.

Despite the fact that it will function regardless of the option, in Desktop Site mode, you can choose the video resolution and the interface will be more familiar.

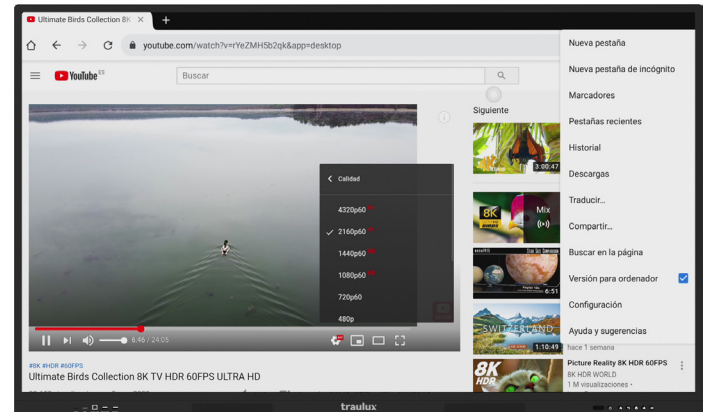



TECHNICAL SPECIFICATIONS INTERACTIVE MONITORS

TX90 SERIES *Simply Better...*

DISPLAY FEATURES

Diagonal
Visual technology
Active area (mm)
Aspect ratio
Contrast (Typ./Dyn)
Resolution
Brightness
Response Time
Viewing angle
Scheduled off time
Auto off time programming
Speakers
Glass
Bonding
LED Panel Life
Blue Light Filter

TRAULUX TX6590

65"
LED
1428.48 (H) x 803.52 (V)
16:9
1200:1 / 5000:1
4K Ultra HD (3840 * 2160)
400 cd/m2 (auto adjust)
5 ms
178°
Yes
Yes
2 x 15 watt
Anti-reflective / Anti-fingerprint
1st Gen.
50,000 Hours
Yes

TRAULUX TX7590

75"
LED
1649.66(H) x 927.94(V)
16:9
1200:1 / 5000:1
4K Ultra HD (3840 * 2160)
400 cd/m2 (auto adjust)
5 ms
178°
Yes
Yes
2 x 15 watt
Anti-reflective / Anti-fingerprint
1st Gen.
50,000 Hours
Yes

TRAULUX TX8590

86"
LED
1895.04(H) x 1065.96(V)
16:9
1200:1 / 5000:1
4K Ultra HD (3840 * 2160)
400 cd/m2 (auto adjust)
5 ms
178°
Yes
Yes
2 x 15 watt
Anti-reflective / Anti-fingerprint
1st Gen.
50,000 Hours
Yes

CONNECTIVITY

HDMI Input
HDMI Output
DisplayPort Input
USB-B (Touch)
USB-A (2.0)
USB-A (3.0)
USB-C
VGA + Audio
RJ45 LAN
RS232
Headset Output
Audio digital output
Microphone Input
Wi-Fi
Bluetooth
OPS Slot

3 (1 front, 2 side)
1 (base - hasta 4K adjustable)
1 (side)
2 (1 front, 1 side)
1 (side)
4 (2 x front, 2 x side)
1 (front, audio, video, 60 watts)
1 (base)
2 (side)
1 (base)
13.5 mm minijack (Dock)
1 SPDIF Optical (Dock)
1 (base)
2.4 / 5GHz Integrated
2.1+EDR/4.2/5.0
1 (JAE 80 pin)

3 (1 front, 2 side)
1 (base - hasta 4K adjustable)
1 (side)
2 (1 front, 1 side)
1 (side)
4 (2 x front, 2 x side)
1 (front, audio, video, 60 watts)
1 (base)
2 (side)
1 (base)
13.5 mm minijack (Dock)
1 SPDIF Optical (Dock)
1 (base)
2.4 / 5GHz Integrated
2.1+EDR/4.2/5.0
1 (JAE 80 pin)

3 (1 front, 2 side)
1 (base - hasta 4K adjustable)
1 (side)
2 (1 front, 1 side)
1 (side)
4 (2 x front, 2 x side)
1 (front, audio, video, 60 watts)
1 (base)
2 (side)
1 (base)
13.5 mm minijack (Dock)
1 SPDIF Optical (Dock)
1 (base)
2.4 / 5GHz Integrated
2.1+EDR/4.2/5.0
1 (JAE 80 pin)

INTERACTIVITY

Technology
Touch accuracy
Response Time
Touch points
Writing tools
Palm erase

IR - Double thickness
1 mm
5 ms
40 touch points (20 writes)
Pencil or finger
Yes

IR - Double thickness
1 mm
5 ms
40 touch points (20 writes)
Pencil or finger
Yes

IR - Double thickness
1 mm
5 ms
40 touch points (20 writes)
Pencil or finger
Yes

ANDROID

Processor
Memory
Automatic updates (OTA)
Interface resolution

Android 9.0, CPU: Quad-core Cortex A73 GPU: MaliG52 MP2

RAM 8G, Flash 64GB
Yes
4K

RAM 8G, Flash 64GB
Yes
4K

RAM 8G, Flash 64GB
Yes
4K

APPS

APK installation
Freeze Image
Floating Icon
Split Mode (2 x apps simultaneously)
Infinite whiteboard
Resize objects in the frame
Duplicate elements in the frame
Android annotation layer
Cutout android layer
QR Generator
Web Navigator
Video Playback
Videostreaming

Yes
Yes
Yes (configurable)
Yes
Yes (1, 2 or 3 independent zones)
Annotations and images (vectorial)
Yes
Yes
Yes (grid, free)
yes (Cloud encrypted)
Yes
Real 4K
Yes up to 4k (youtube)

Yes
Yes
Yes (configurable)
Yes
Yes (1, 2 or 3 independent zones)
Annotations and images (vectorial)
Yes
Yes
Yes (grid, free)
yes (Cloud encrypted)
Yes
Real 4K
Yes up to 4k (youtube)

Yes
Yes
Yes (configurable)
Yes
Yes (1, 2 or 3 independent zones)
Annotations and images (vectorial)
Yes
Yes
Yes (grid, free)
yes (Cloud encrypted)
Yes
Real 4K
Yes up to 4k (youtube)

Mirroring

EsharePRO 4K: 9 simultaneous projections, compatible in its own Hot Spot (2.4 Gb / 5 gb) with outgoing internet transmission (LAN) to devices. Android, iOS (Airplay direct), Chrome, Ubuntu Windows (2 Touch) and MAC O.S (2 touch)

INCLUDED ACCESSORIES

Wall bracket
Pencil dubbing tip
Remote control
USB-C cable (Thunderbolt 3)
Power cable
HDMI cable
USB A-B cable

Yes
2
1
1
1 x 3 m
1 x 3 m
1 x 3 m

Yes
2
1
1
1 x 3 m
1 x 3 m
1 x 3 m

Yes
2
1
1
1 x 3 m
1 x 3 m
1 x 3 m

SIZE / WEIGHT

VESA
Net Weight (kg ±2)
Dimensions (W. x D. x H.)

600 x 400
47
1511,6 x 87,8 x 920,3 mm

800 x 400
65
1722,5 x 87,1 x 1034,6 mm

800 x 600
95
1.967 x 87,1 x 1172,6 mm

POWER

Voltage
Consumption

100 -240V AC
Max. 300W-at stand-by <0.5W

100 -240V AC
Máx. 380W-at stand-by <0.5W

100 -240V AC
Máx. 460W-at stand-by <0.5W

WARRANTY

5 years In Situ with reinstallation (Spain / Portugal)

5 years In Situ with reinstallation (Spain / Portugal)

5 years In Situ with reinstallation (Spain / Portugal)

TECHNICAL DRAWINGS

INTERACTIVE MONITORS

TX90 - TX6590 SERIES

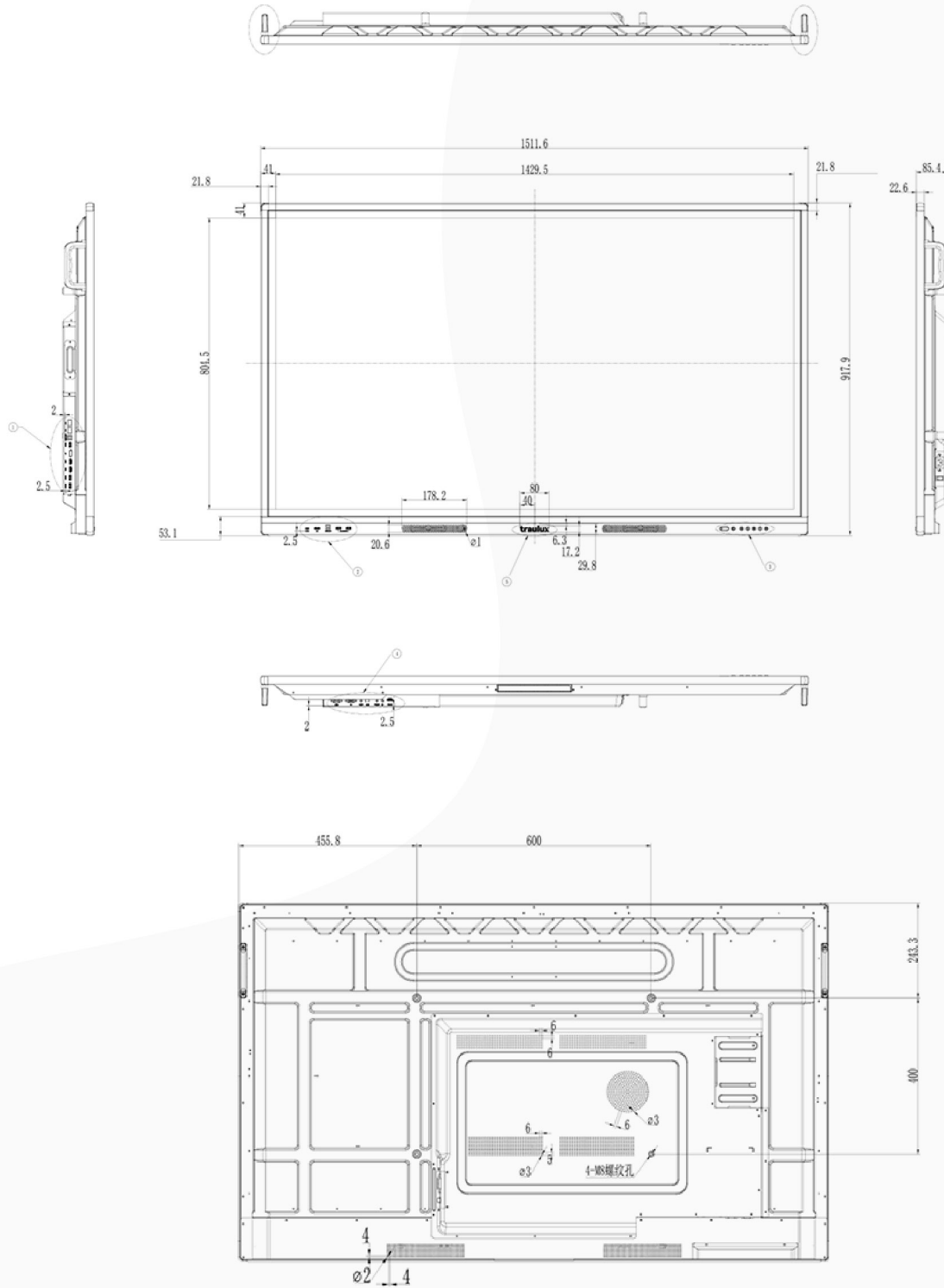

TECHNICAL DRAWINGS

INTERACTIVE MONITORS

TX90 - TX7590 SERIES

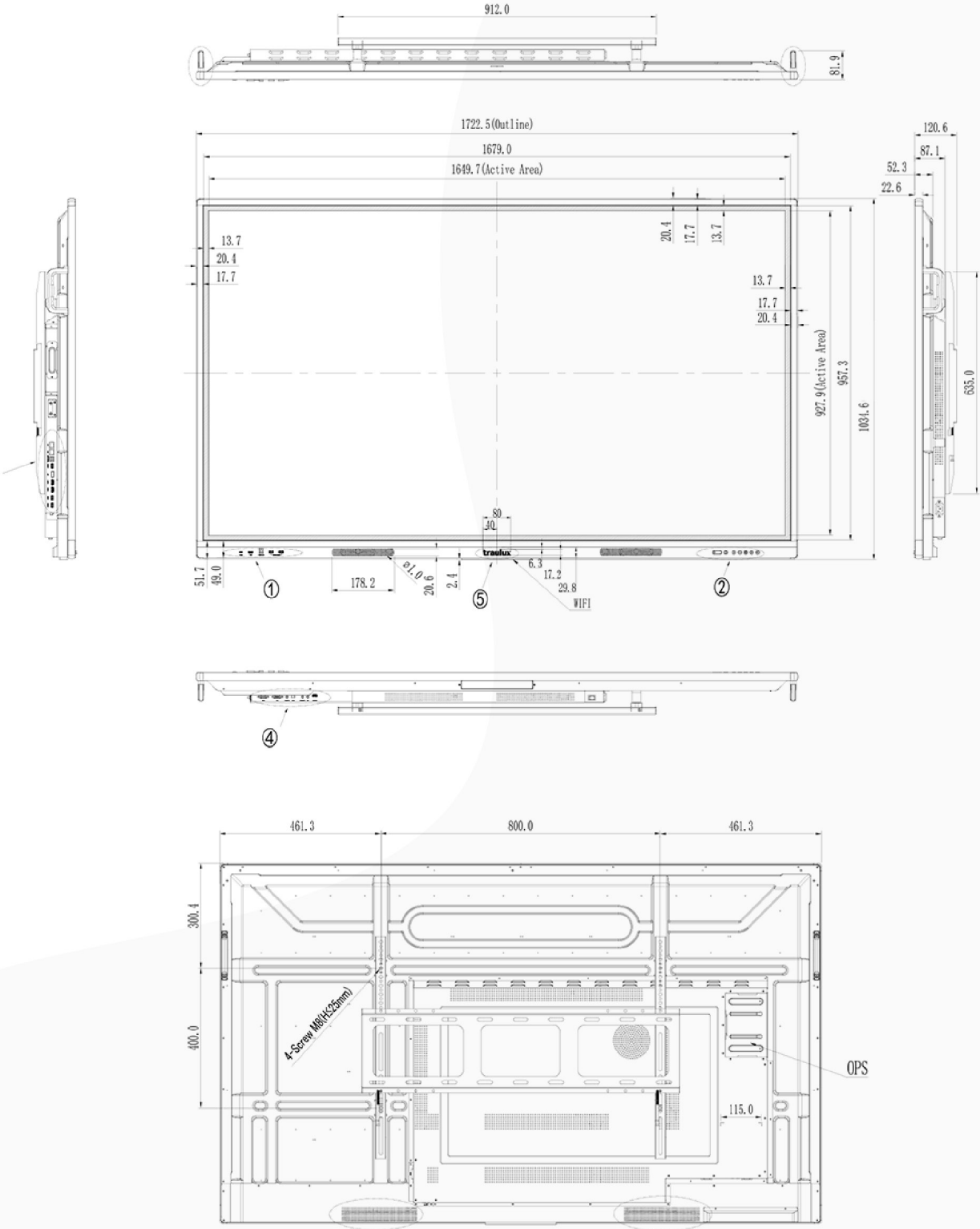

TECHNICAL DRAWINGS

INTERACTIVE MONITORS

TX90 - TX8690 SERIES

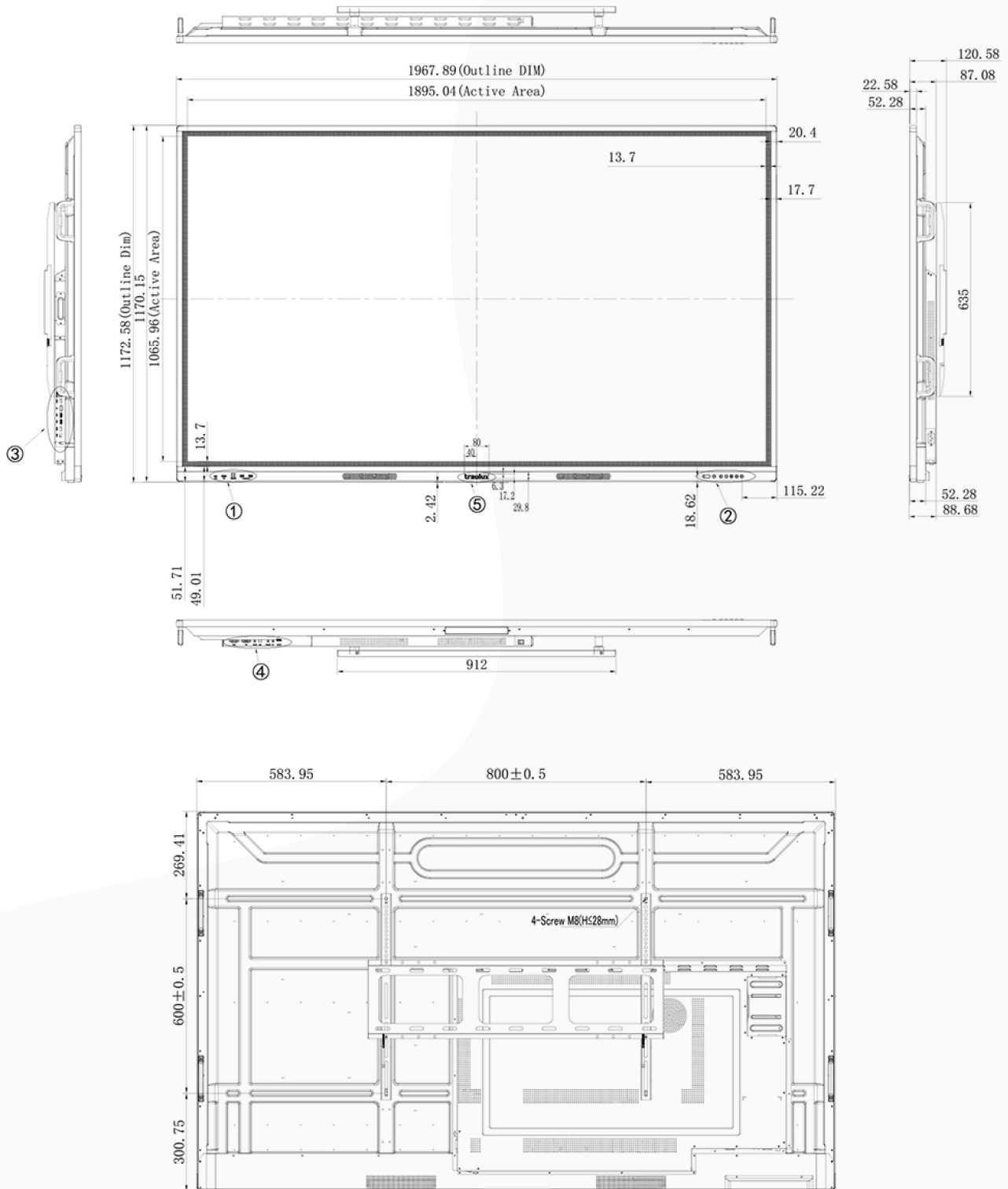



RS232 COMMANDS
INTERACTIVE MONITORS
TX90 SERIES *Simply Better...*

COMMANDS RS232

Instruction	Index
6B303173413030300	HDTV_Power_STBY
6B303173413030310D	HDTV_Power_ON
6B303173423030340D	Input_HDMI
6B303173423031340D	Input_HDMI1
6B303173423032340D	Input_HDMI2
6B303173423030360D	Input_VGA
6B303173423030370D	Input_OPS1
6B303173423030380D	Input_USB
6B303173423030390D	Input_DP
6B303173423030410D	Input_Android
6B303173433x3x3x0D	Contrast
6B303173443x3x3x0D	Brightness
6B303173453x3x3x0D	Sharpness
6B303173463x3x3x0D	Saturation
6B303173473x3x3x0D	Hue
6B303173483030300D	Color_Mode_NORMAL
6B303173483030310D	Color_Mode_WARM
6B303173483030320D	Color_Mode_COLD
6B303173483030330D	Color_Mode_USER
6B3031734A3x3x3x0D	Bass
6B3031734B3x3x3x0D	Treble
6B3031734C3x3x3x0D	Balance
6B3031734E3030300D	OSD_Language_English
6B3031734E3030310D	OSD_Language_French
6B3031734E3030320D	OSD_Language_Spanish
6B3031734E3030330D	OSD_Language_Traditional_C
6B3031734E3030340D	OSD_Language_Simple_Chines
6B3031734F3030300D	Power_Lock_Unlock
6B3031734F3030310D	Power_Lock_Lock
6B303173503x3x3x0D	Volume
6B303173503230300D	Volume_Down

COMMANDS RS232

Instruction	Index
6B303173503230310D	Volume_Up
6B303173513030300D	Mute_OFF
6B303173513030310D	Mute_ON
6B303173523030300D	Button_Lock_Unlock
6B303173523030310D	Button_Lock_lock
6B303173533030300D	Menu_Lock_Unlock
6B303173533030310D	Menu_Lock_lock
6B303173543x3x3x0D	Number
6B303173553030300D	Key_Pad_UP
6B303173553030310D	Key_Pad_DOWN
6B303173553030320D	Key_Pad_LEFT
6B303173553030330D	Key_Pad_RIGHT
6B303173553030340D	Key_Pad_ENTER
6B303173553030350D	Key_Pad_INPUT
6B303173553030360D	Key_Pad_MENU
6B303173553030370D	Key_Pad_EXIT
6B303173563030300D	Remote_Control_DISABLE
6B303173563030310D	Remote_Control_ENABLE
6B3031735859xxxx0D	Date_Year
6B303173584Dxxxx0D	Date_Month
6B3031735844xxxx0D	Date_Day
6B3031735948xxxx0D	Date_Hour
6B303173594Dxxxx0D	Date_Min
6B3031735953xxxx0D	Date_Sec
6B3031735A3030300D	Restore_Default
6B303167613030300D	Get_Constrast
6B303167623030300D	Get_Brightness
6B303167633030300D	Get_Sharpness
6B303167643030300D	Get_Saturation
6B303167653030300D	Get_Hue
6B303167663030300D	Get_Volume

COMMANDS RS232

Instruction	Index	Note
6B303167673030300D	Get_Mute	
6B303167683030300D	Get_Input_Source	
6B303167693030300D	Get_Power_Status	
6B3031676A3030300D	Get_Remote_Control	
6B3031676B3030300D	Get_Power_Lock	Lock IR and KeyPad
6B3031676C3030300D	Get_Button_Lock	Block the Android "MENU" function
6B3031676D3030300D	Get_Menu_Lock	
6B3031676E3030300D	Get_Temperature	Get the system running time
6B3031676F3030300D	Get_Operation_Time	
6B303167704D30300D	Get_Date_Month	
6B303167704430300D	Get_Date_Day	
6B303167714830300D	Get_Date_Hour	
6B303167714D30300D	Get_Date_Min	
6B303167715330300D	Get_Date_Sec	
6B303167723030300D	Get_Device_Name	
6B303167733030300D	Get_MAC_Addr	

Returned Value Specification

Instruction
Return_Constrast = 6B303172613x3x3x0D
Return_Brightness = 6B303172623x3x3x0D
Return_Sharpness = 6B303172633x3x3x0D
Return_Saturation = 6B303172643x3x3x0D
Return_Hue = 6B303172653x3x3x0D
Return_Volume = 6B303172663x3x3x0D
Return_Mute_On = 6B303172673030310D
Return_Mute_Off = 6B303172673030300D
Return_Input_Source = 6B 30 31 72 68 3x 3x 3x 0D
Return_Input_HDMI_NoSignal = 6B303172683030340D
Return_Input_HDMI1_NoSignal = 6B303172683031340D
Return_Input_HDMI2_NoSignal = 6B303172683032340D
Return_Input_VGA_NoSignal = 6B303172683030360D

COMMANDS RS232

Returned Value Specification

Instruction	Notes
Return_Input_OPSt_NoSignal = 6B303172683030370D	
Return_Input_USB_NoSignal = 6B303172683030380D	
Return_Input_DP_NoSignal = 6B303172683030390D	
Return_Input_Android_NoSignal = 6B303172683030410D	
Return_Input_HDMI_Signal = 6B303172683130340D	
Return_Input_HDMI1_Signal = 6B303172683131340D	
Return_Input_HDMI2_Signal = 6B303172683132340D	
Return_Input_VGA_Signal = 6B303172683130360D	
Return_Input_OPSt_Signal = 6B303172683130370D	
Return_Input_USB_Signal = 6B303172683130380D	
Return_Input_DP_Signal = 6B303172683130390D	
Return_Input_Android_Signal = 6B303172683130410D	
Return_Power_Status = 6B303172693030310D	Here the system shows the string "Now on"
Return_Remote_Control_On = 6B3031726A3030310D	
Return_Remote_Control_Off = 6B3031726A3030300D	
Return_Power_Lock = 6B3031726B3030310D	
Return_Power_Unlock = 6B3031726B3030300D	
Return_Button_Lock = 6B3031726C3030310D	
Return_Button_Unlock = 6B3031726C3030300D	
Return_Menu_Lock = 6B3031726D3030310D	
Return_Menu_Unlock = 6B3031726D3030300D	
Return_Temperature = 6B3031726E3x3x3x0D	
Return_Operation_Time = 6B30316F3x3x3x3x0D	
Return_Date_Month = 6B303172704Dxxxx0D	
Return_Date_Day = 6B3031727044xxxx0D	
Return_Date_Hour = 6B3031727148xxxx0D	
Return_Date_Min = 6B303172714Dxxxx0D	
Return_Date_Sec = 6B3031727153xxxx0D	
Return_Device_Name = 6B3031723xxxxxxx0D	
Return_MAC_Addr = 6B303172733xxxxx0D	

traulux

INTERACTIVE MONITORS

TX90 SERIES

TX6590 | TX7590 | TX8690



DISCOVER

Simply Better...

PHILOSOPHY

USER'S MANUAL 2022 - 2023

charmex.net | traulux.net